

REVISIONS

P	LTR	DESCRIPTION	DATE	DWN	APVD
	A	NEW DRAWING	21MAY2018	GCM	AP

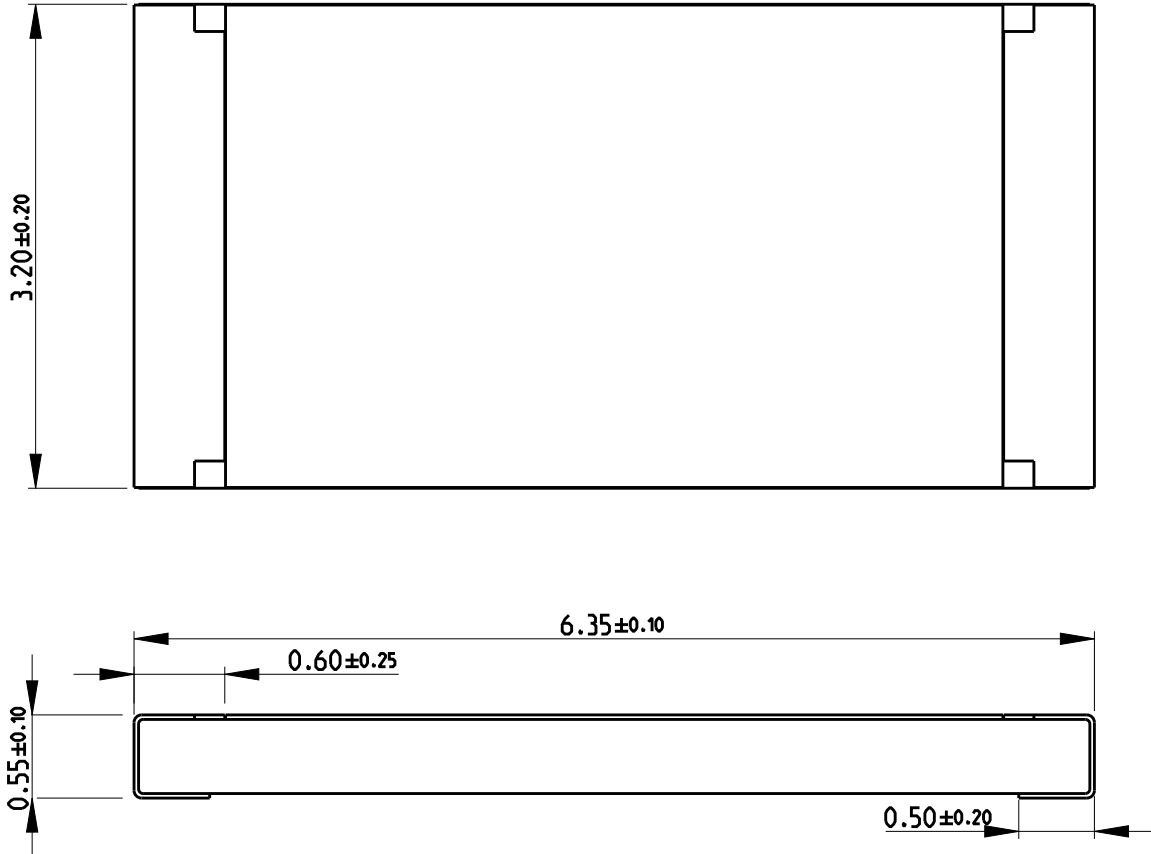

NOTES:

- FOR FURTHER INFORMATION SEE DATA SHEET FOR CRGCQ SERIES SMD AEC-Q200 THICK FILM CHIP RESISTORS

RoHS Compliant

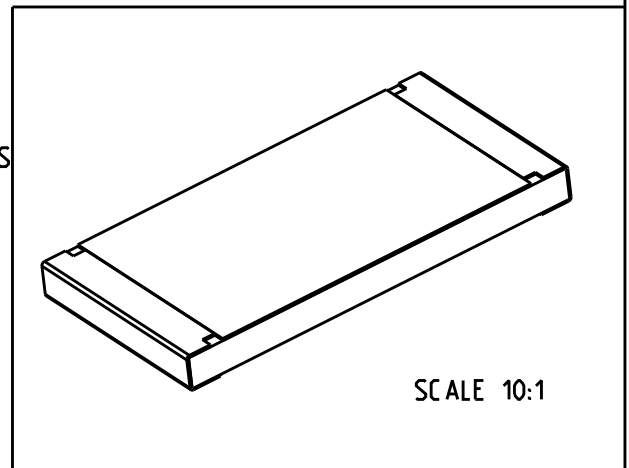

RELEASED FOR PUBLICATION

ALL RIGHTS RESERVED.

THIS DRAWING IS UNPUBLISHED.

© COPYRIGHT copyright_date BY -

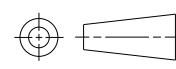
DIMENSIONS:		DWN	21MAY2018	MATERIAL	FINISH	
mm		GANESH C M		-		-
TOLERANCES UNLESS OTHERWISE SPECIFIED:		CHK	21MAY2018	 TE Connectivity		
0 PLC ±0.5		ALLAN.P				
1 PLC ±0.2		APVD	21MAY2018	NAME SMD AEC-Q200 COMPLIANT THICK FILM CHIP RESISTOR TYPE CRGCQ 2512 SERIES		
2 PLC ±0.1		ALLAN.P				
3 PLC ±		PRODUCT SPEC	-	SIZE	CAGE CODE	DRAWING NO
4 PLC ±		APPLICATION SPEC	-	A4	00779	C-2176350
ANGLES 5°		WEIGHT	-	RESTRICTED TO		-
		CUSTOMER DRAWING		SCALE	SHEET	REV
				20:1	1 OF 1	A