

REVISIONS

P	LTR	DESCRIPTION	DATE	DWN	APVD
	A	NEW DRAWING	21MAY2018	GCM	AP

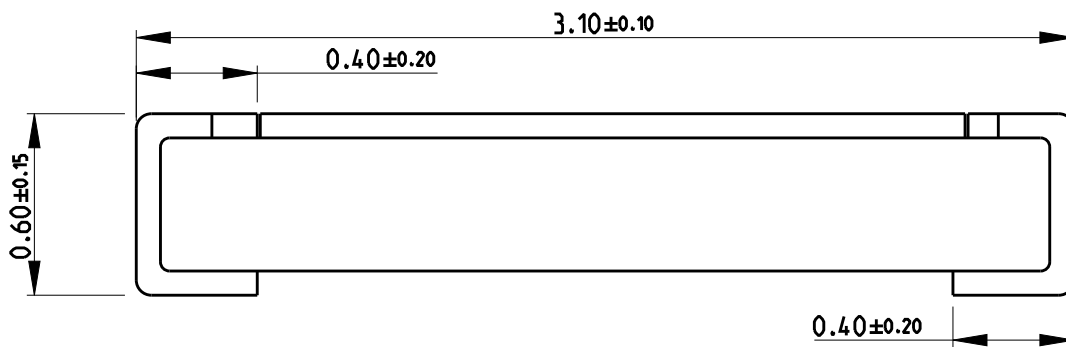
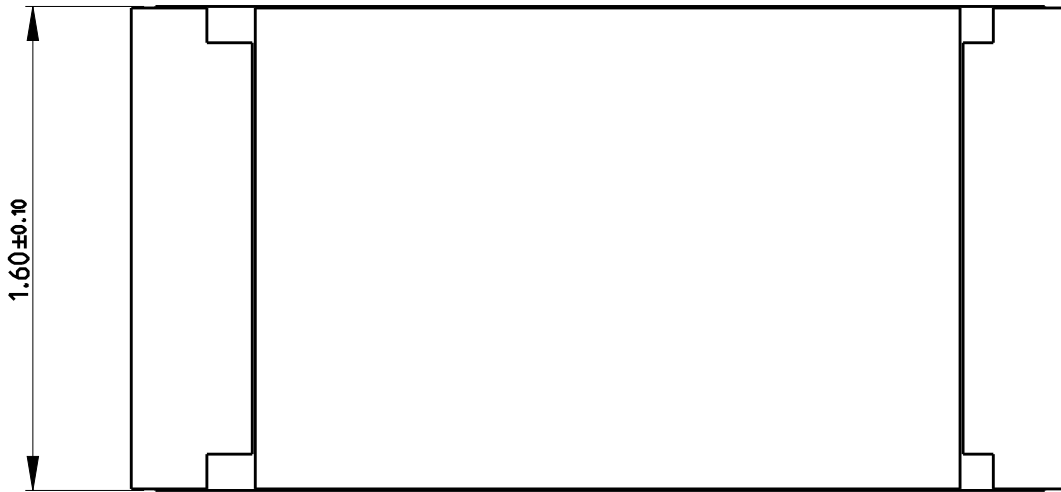

NOTES:

- FOR FURTHER INFORMATION SEE DATA SHEET FOR RQ73 SERIES AEC-Q200 THIN FILM PRECISION RESISTORS.

RoHS Compliant

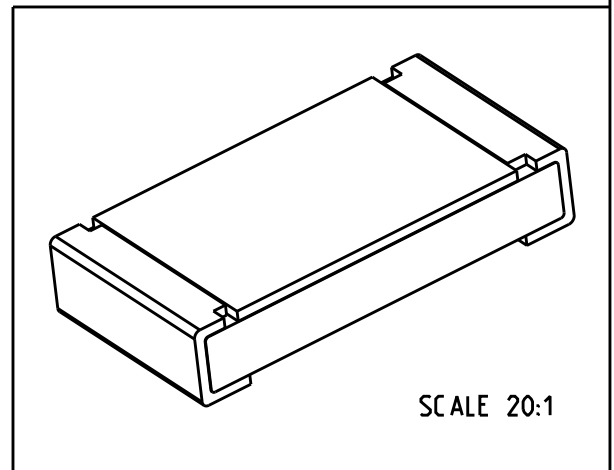

RELEASED FOR PUBLICATION

ALL RIGHTS RESERVED.

THIS DRAWING IS UNPUBLISHED.

© COPYRIGHT copyright_date BY -

DIMENSIONS:		DWN	21MAY2018	MATERIAL	-	FINISH	-
mm		GANESH C M		TE Connectivity			
TOLERANCES UNLESS OTHERWISE SPECIFIED:		CHK	21MAY2018				
0 PLC	±0.5	ALLAN.P		NAME SMD Thin Film Precision Resistors - AEC-Q200 Compliant - Type RQ73 1206 Series			
1 PLC	±0.2	APVD	21MAY2018				
2 PLC	±0.1	ALLAN.P		SIZE	CAGE CODE	DRAWING NO	RESTRICTED TO
3 PLC	±	PRODUCT SPEC	-	A4	00779	C-2176384	-
4 PLC	±	APPLICATION SPEC	-	SCALE 40:1 SHEET 1 OF 1 REV A			
ANGLES	±5°	WEIGHT	-				
		CUSTOMER DRAWING					