

THIS DRAWING IS UNPUBLISHED. RELEASED FOR PUBLICATION 20
 © COPYRIGHT 20 BY - ALL RIGHTS RESERVED.

LOC	DIST	REVISIONS			
P	LTR	DESCRIPTION	DATE	DWN	APVD
-	-	A	INITIAL RELEASE	08-Jan-13	LZH MYH

TABLE 1

NO.	NAME	MATERIAL
1	POST CONTACT	BRASS, FINISH; TIN PLATING
2	HDR HOUSING	PA 66 GF UL94 V-0

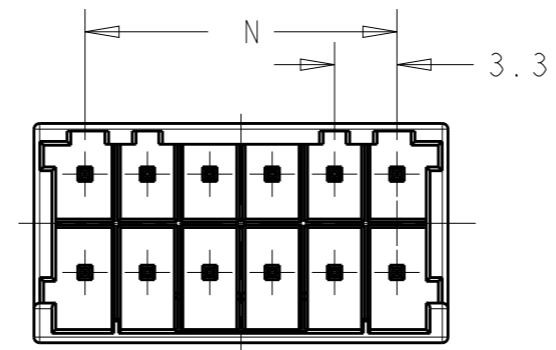

- NOTES:
- 1. RECOMMENDED PCB LAYOUT
 - 2. APPLICABLE PCB THICKNESS 1.6MM
 - 3. MATERIAL SEE TABLE 1
 - 4. KINK FORM SEE TABLE 2
 - 5. MATING PLUG HOUSING SEE TABLE 3
 - 6. PIN DIMENSION

KINK POSITION TABLE 2

POSITION	KINK A	KINK B
4	1,2	3,4
6	1,3	4,6
8	1,4	5,8
10	1,5	6,10
12	1,6	7,12

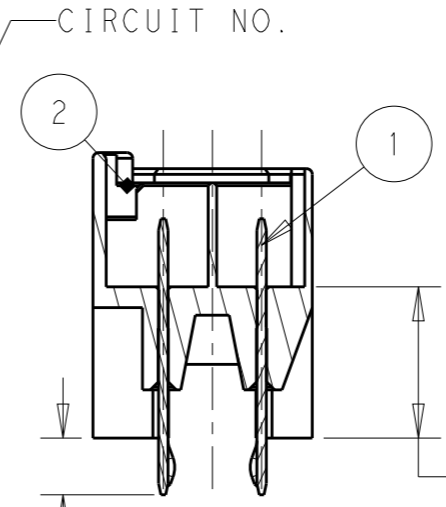
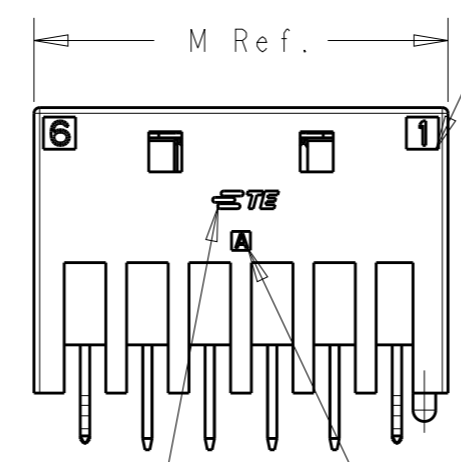
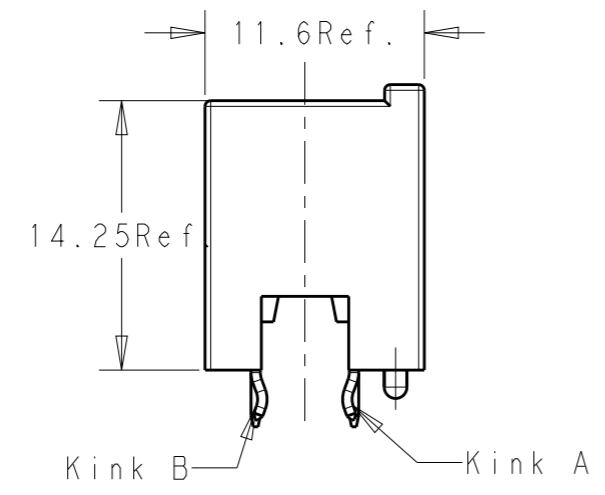

MATING PLUG P/N	COLOR	KEYING	N	M	POS	PART NO.
4-1971905-6	YELLOW	D	16.5	21.9	12	4-1971906-6
3-1971905-6	RED	C			12	3-1971906-6
2-1971905-6	BLUE	B	13.2	18.6	12	2-1971906-6
1-1971905-6	NATURAL	A			12	1-1971906-6
4-1971905-5	YELLOW	D	10	10	10	4-1971906-5
3-1971905-5	RED	C			10	3-1971906-5
1-1971905-5	BLUE	B	10	10	10	2-1971906-5
1-1971905-5	NATURAL	A			10	1-1971906-5
4-1971905-4	YELLOW	D	9.9	15.3	8	4-1971906-4
3-1971905-4	RED	C			8	3-1971906-4
2-1971905-4	BLUE	B	8	8	8	2-1971906-4
1-1971905-4	NATURAL	A			8	1-1971906-4
4-1971905-3	YELLOW	D	6.6	12	6	4-1971906-3
3-1971905-3	RED	C			6	3-1971906-3
2-1971905-3	BLUE	B	6	6	6	2-1971906-3
1-1971905-3	NATURAL	A			6	1-1971906-3
4-1971905-2	YELLOW	D	3.3	8.7	4	4-1971906-2
3-1971905-2	RED	C			4	3-1971906-2
2-1971905-2	BLUE	B	4	4	4	2-1971906-2
1-1971905-2	NATURAL	A			4	1-1971906-2
MATING PLUG P/N	COLOR	KEYING	N	M	POS	PART NO.

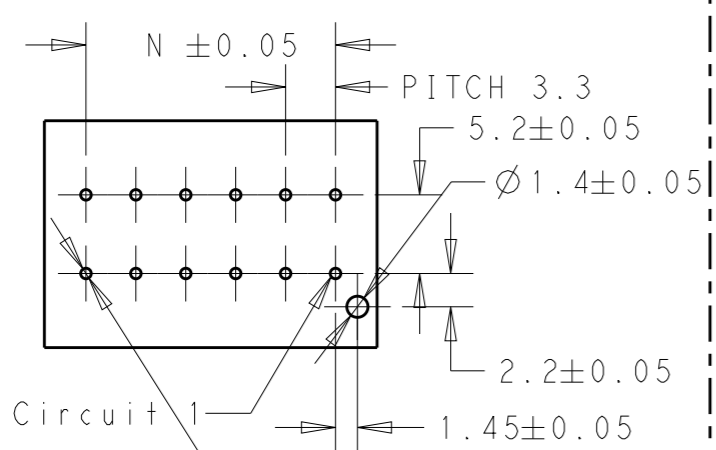

PUNCHED HOLE: $\varnothing 0.7^{+0.1}_0$
 DRILLED HOLE: $\varnothing 0.8 \pm 0.05$

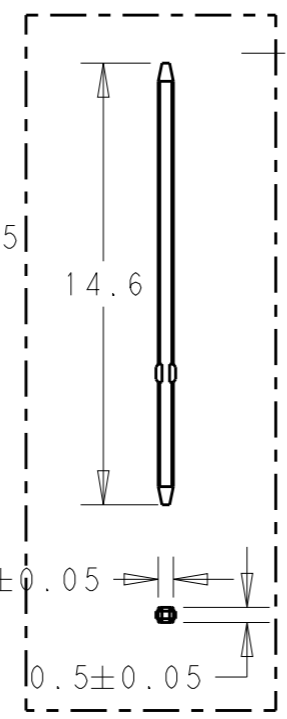

6 Pin

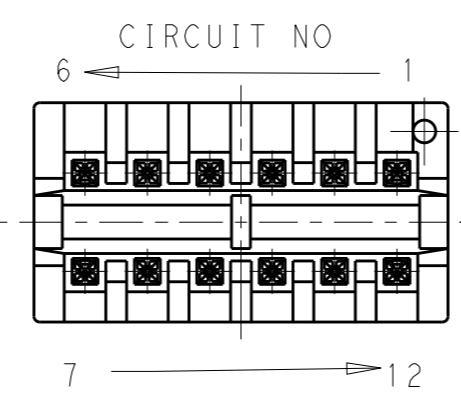

THIS DRAWING IS A CONTROLLED DOCUMENT.

DIMENSIONS:	TOLERANCES UNLESS OTHERWISE SPECIFIED:
mm	0 PLC ±-
	1 PLC ±0.5
	2 PLC ±0.13
	3 PLC ±0.013
	4 PLC ±0.0001
	ANGLES ±-
MATERIAL	FINISH
-3	-

DWN	LZH	18-Jan-13
CHK	HAPYE.WU	18-Jan-13
APVD	YH.MAO	18-Jan-13
PRODUCT SPEC	108-106094	
APPLICATION SPEC	-	
WEIGHT	-	

STE TE Connectivity

NAME: NEXT GENERATION G13.3 HEADER ASSEMBLY 2 ROW

SIZE	CAGE CODE	DRAWING NO	RESTRICTED TO
A3	00779	C-1971906	-

Customer Drawing SCALE - SHEET 1 OF 1 REV A