

20POS(X-KEY): 1-1827864-0

LOC	DIST	REVISIONS 変更					
J		P	LTR	DESCRIPTION	DATE	DWN	APVD
			C3	REVISED	18OCT2012	H.U	N.Y

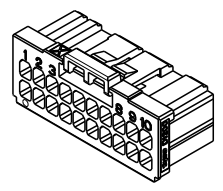

SCALE 1:1

1. MATERIAL: GLASS FILLED THERMO PLASTIC POLYESTER(94V-0), COLOR: BLACK
 2. THE SHAPE, SIZE AND POSITION OF THE CHARACTER SHOW THE OUTLINE. THEY DON'T SHOW DETAILS.
 3. THE KEYING ARRANGEMENT OF "Y" IS SYMMETRIC WITH "X".
 4. DIFFERENT HEIGHT OF ROCK PROTECTOR. A FINGERTIP IS STOOD AND PUSHED WHEN OPERATING A LOCK LEVER.
1. 材料: ガラス入り熱可塑性ポリエステル樹脂(94V-0), 色: 黒
2. 文字の形状、大きさ、および位置については、大略を示すものであり、詳細を示すものではありません。
3. Y KEY形状は、X KEY形状と左右対称
4. ROCK PROTECTORの高さ違いです。ロックレバー操作の際には、指先を立て押ししてください。

20	Y	9	22.5	25.9	27.6	8.3	2-1827864-0
20	X	9	22.5	25.9	27.6	8.3	1-1827864-0
16	Y	7	17.5	20.9	22.6	8.3	2-1827864-8
16	X	7	17.5	20.9	22.6	8.3	1-1827864-8
12	Y	5	12.5	15.9	17.6	8.3	2-1827864-6
12	X	5	12.5	15.9	17.6	8.3	1-1827864-6
10	Y	4	10.0	13.4	15.1	3.3	2-1827864-5
10	X	4	10.0	13.4	15.1	3.3	1-1827864-5
8	Y	3	7.5	10.9	12.6	3.3	2-1827864-4
8	X	3	7.5	10.9	12.6	3.3	1-1827864-4
6	Y	2	5.0	8.4	10.1	3.3	2-1827864-3
6	X	2	5.0	8.4	10.1	3.3	1-1827864-3
6	X	2	5.0	8.4	10.1	3.3	4 9-1827864-3
4	Y	1	2.5	5.9	7.6	3.1	2-1827864-2
4	X	1	2.5	5.9	7.6	3.1	1-1827864-2
POS	KEY	n	A	B	C	D	PART NO

THIS DRAWING IS A CONTROLLED DOCUMENT.

DWN T. KUDO 23AUG2005
CHK D. MITSUGI 23AUG2005
APVD D. MITSUGI 23AUG2005

PRODUCT SPEC 108-78268, 78298
APPLICATION SPEC 114-5377

WEIGHT

TE Connectivity

NAME 名称 DYNAMIC D1200D 2.5mm PITCH REC HSG 4-20 POS

SIZE A3 CAGE CODE 300779 DRAWING NO 番号 C-1827864 RESTRICTED TO

CUSTOMER DRAWING SCALE 尺度 1:1 SHEET 1 OF 3 REV C3

4

3

2

1

THIS DRAWING IS UNPUBLISHED.

RELEASED FOR PUBLICATION

LOC

DIST

REVISIONS

変更

© COPYRIGHT

ALL RIGHTS RESERVED.

P

LTR

DESCRIPTION

DATE

DWN

APVD

SEE SHEET 1 OF 3

CAVITY MARK ONLY 4POS

2.5Xn=A

2.5Xn=A

2.5Xn=A

2.5Xn=A

2.5Xn=A

2.5Xn=A

4 12.65

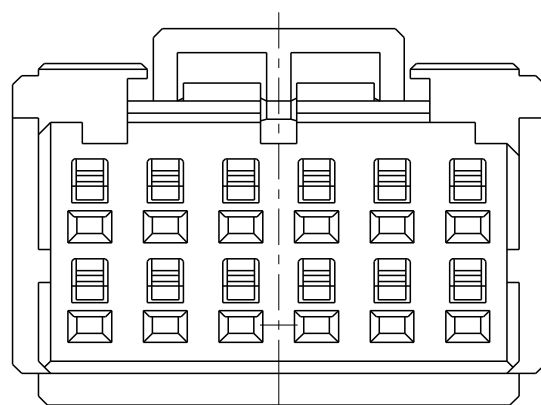
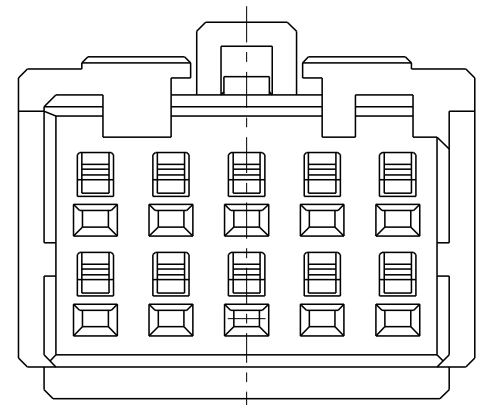
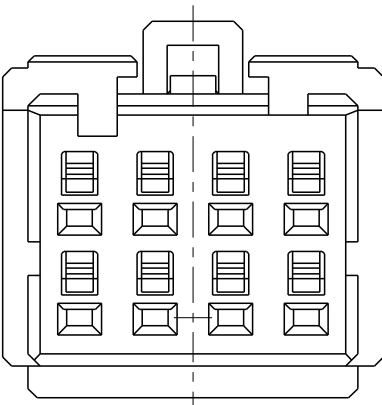
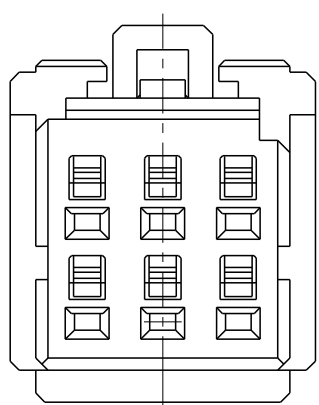
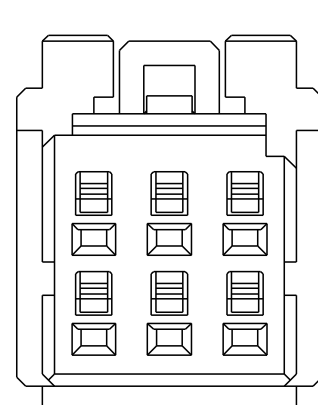
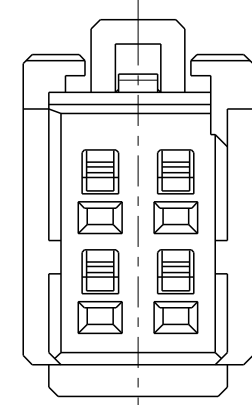
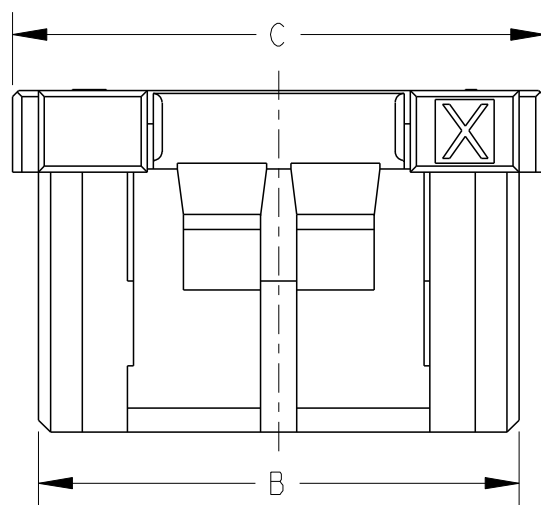
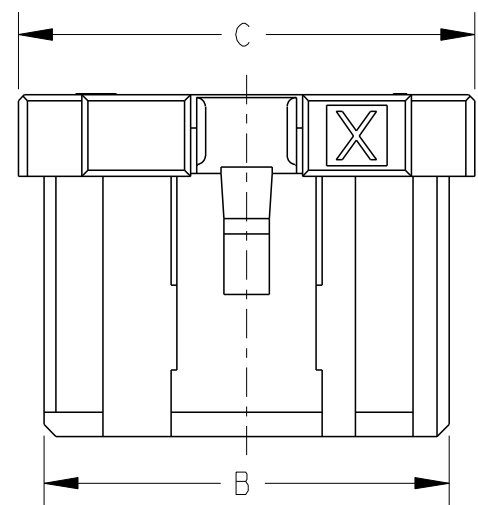
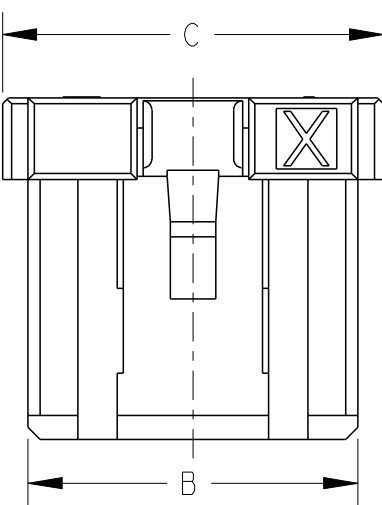
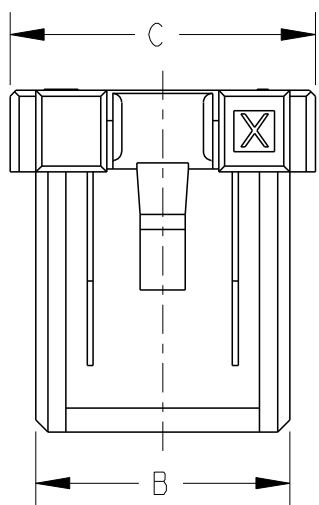
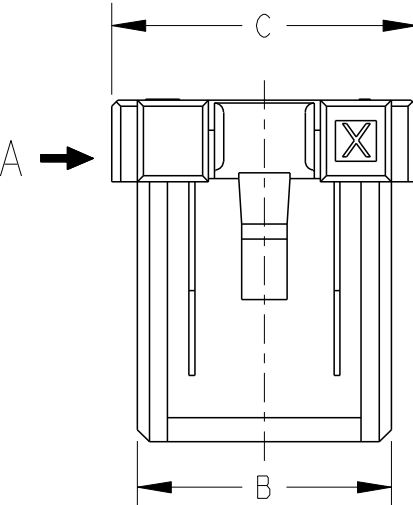
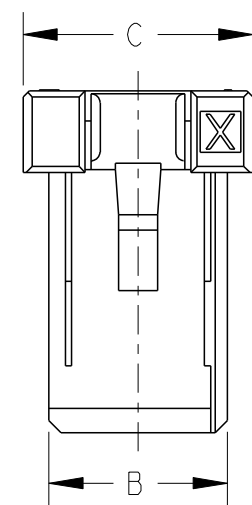
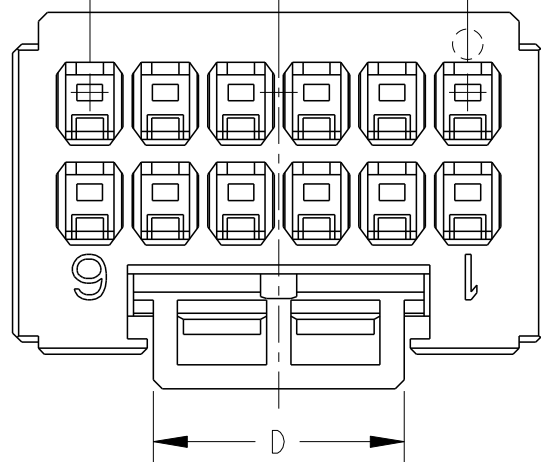
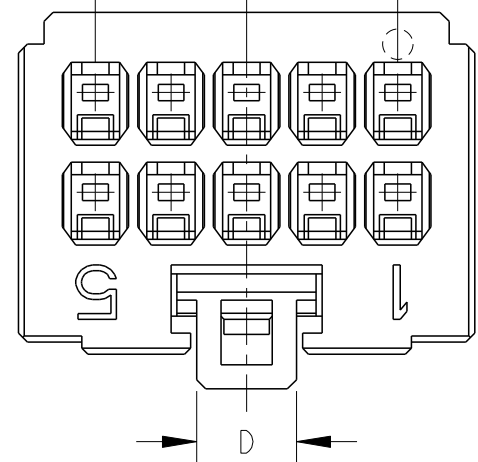
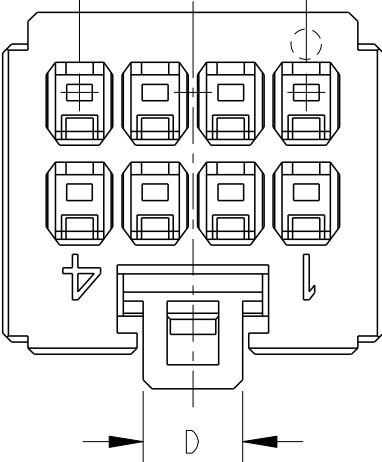
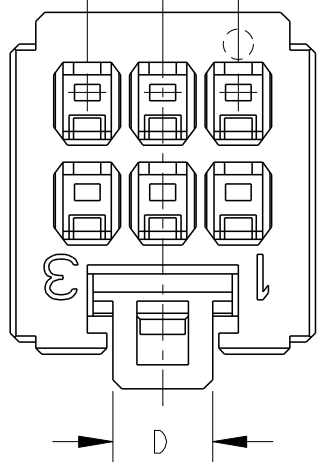
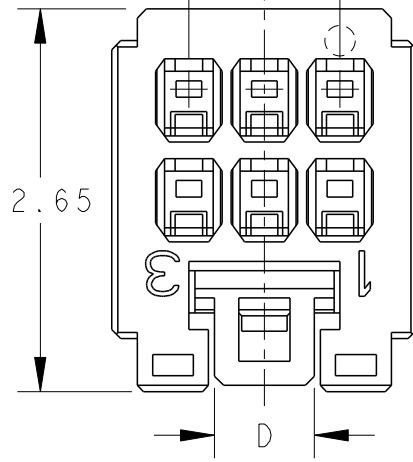
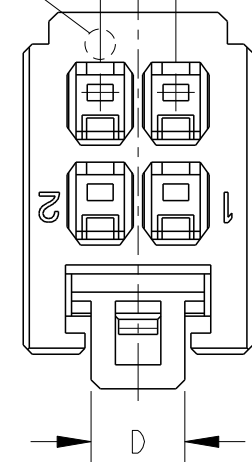

4POS(X-KEY)
1-1827864-2

4 6POS(X-KEY)
9-1827864-3

6POS(X-KEY)
1-1827864-3

8POS(X-KEY): 1-1827864-4 10POS(X-KEY): 1-1827864-5

12POS(X-KEY): 1-1827864-6

LOGO MARK
SERIES CODE



VIEW A

THIS DRAWING IS A CONTROLLED DOCUMENT.

DIMENSIONS:
単位: 耗
mm

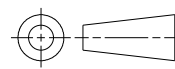

TOLERANCES UNLESS OTHERWISE SPECIFIED:

一般公差	
0 PLC	±
1 PLC	±
2 PLC	±
3 PLC	±
4 PLC	±
ANGLES	±
FINISH	仕上

MATERIAL
材料

DWN	T. KUDO	23AUG2005
CHK	D. MITSUGI	23AUG2005
APVD	D. MITSUGI	23AUG2005
PRODUCT SPEC	108-78268, 78298	
製品規格	108-78268, 78298	
APPLICATION SPEC	114-5377	
取付適用規格	114-5377	
WEIGHT		



TE Connectivity

NAME
名称
DYNAMIC D1200D 2.5mm PITCH
REC HSG
4-20 POS

SIZE	CAGE CODE	DRAWING NO 番号	RESTRICTED TO
A3	00779	C-1827864	

CUSTOMER DRAWING

SCALE
尺度 4:1 SHEET 2 OF 3 REV C3

THIS DRAWING IS UNPUBLISHED.

RELEASED FOR PUBLICATION

© COPYRIGHT -

ALL RIGHTS RESERVED.

LOC	DIST	REVISIONS					
		P	LTR	DESCRIPTION	DATE	DWN	APVD
J		-		SEE SHEET 1	-	-	-

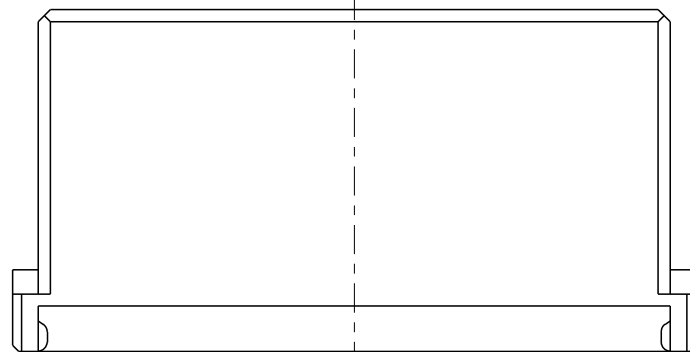
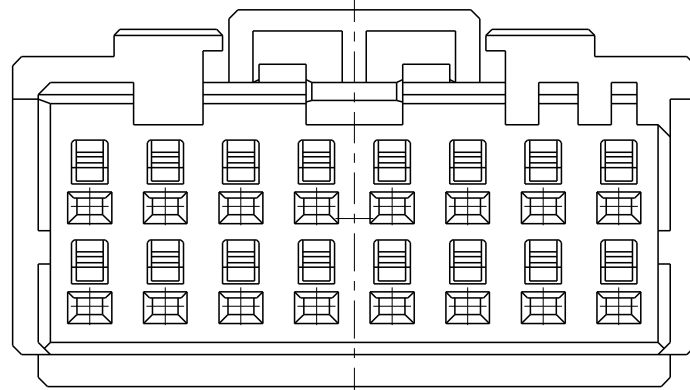
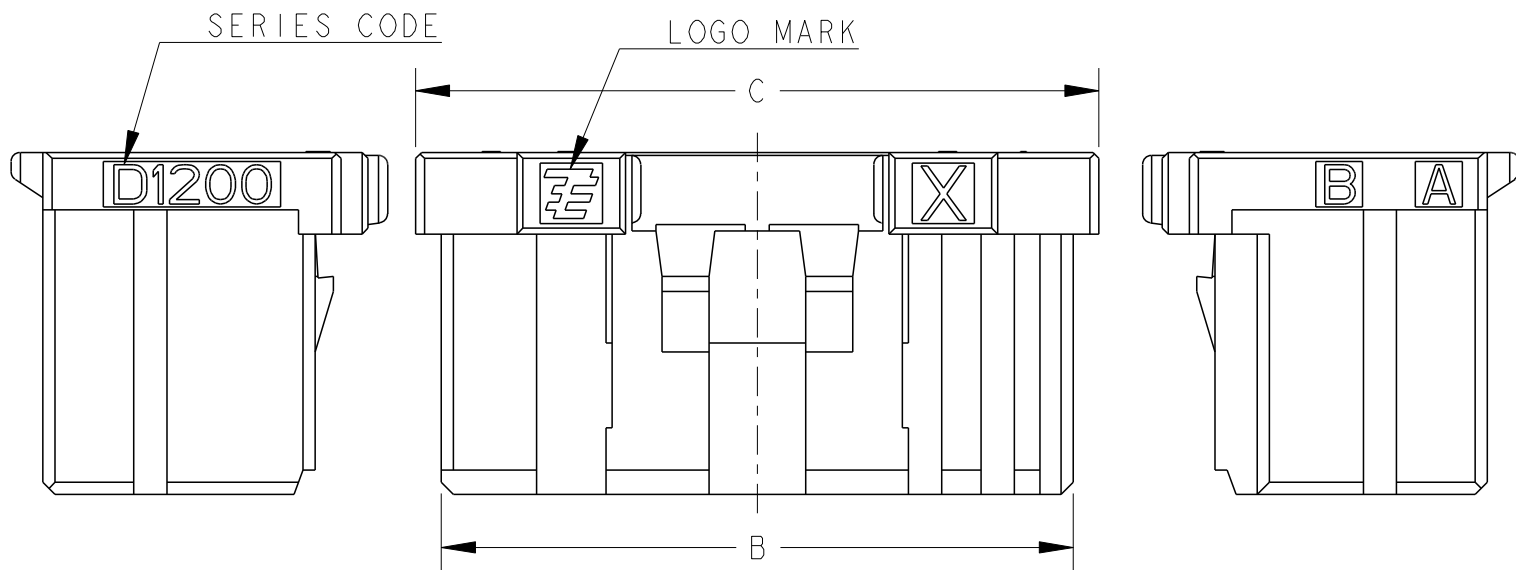
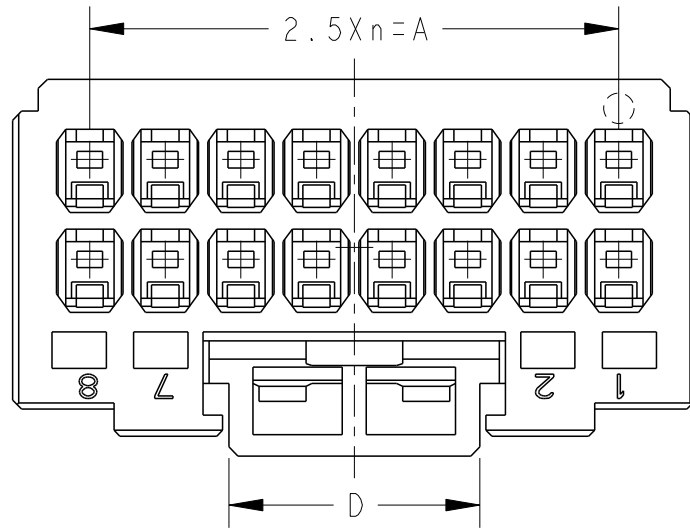

16 POS(X-KEY) : 1-1827864-8

THIS DRAWING IS A CONTROLLED DOCUMENT.		DWN T. KUDO 23AUG2005	 TE Connectivity	
DIMENSIONS: 単位: 耗 mm		CHK D. MITSUGI 23AUG2005		
TOLERANCES UNLESS OTHERWISE SPECIFIED: 一般公差		APVD D. MITSUGI 23AUG2005	NAME 名称 DYNAMIC D1200D 2.5mm PITCH REC HSG 4-20 POS	
MATERIAL 材料		PRODUCT SPEC 製品規格 108-78268, 78298	SIZE A3	CAGE CODE 300779
FINISH 仕上		APPLICATION SPEC 取付適用規格 114-5377	DRAWING NO 番号 C-1827864	RESTRICTED TO
WEIGHT		SCALE 尺度 1:1		SHEET 3 OF 3
CUSTOMER DRAWING		REV C3		

D

C

B

A