

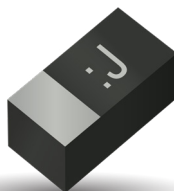

A KYOCERA GROUP COMPANY

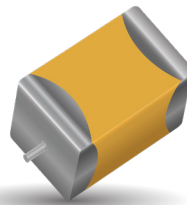

Polymer, Tantalum and Niobium Oxide Capacitors

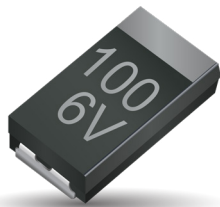
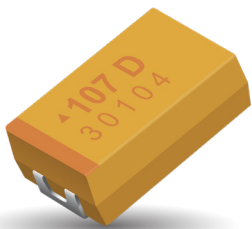

IMPORTANT INFORMATION/DISCLAIMER

All product specifications, statements, information and data (collectively, the “Information”) in this datasheet or made available on the website are subject to change. The customer is responsible for checking and verifying the extent to which the Information contained in this publication is applicable to an order at the time the order is placed. All Information given herein is believed to be accurate and reliable, but it is presented without guarantee, warranty, or responsibility of any kind, expressed or implied.

Statements of suitability for certain applications are based on AVX’s knowledge of typical operating conditions for such applications, but are not intended to constitute and AVX specifically disclaims any warranty concerning suitability for a specific customer application or use.

ANY USE OF PRODUCT OUTSIDE OF SPECIFICATIONS OR ANY STORAGE OR INSTALLATION INCONSISTENT WITH PRODUCT GUIDANCE VOIDS ANY WARRANTY.

The Information is intended for use only by customers who have the requisite experience and capability to determine the correct products for their application. Any technical advice inferred from this Information or otherwise provided by AVX with reference to the use of AVX’s products is given without regard, and AVX assumes no obligation or liability for the advice given or results obtained.

Although AVX designs and manufactures its products to the most stringent quality and safety standards, given the current state of the art, isolated component failures may still occur. Accordingly, customer applications which require a high degree of reliability or safety should employ suitable designs or other safeguards (such as installation of protective circuitry or redundancies) in order to ensure that the failure of an electrical component does not result in a risk of personal injury or property damage.

Unless specifically agreed to in writing, AVX has not tested or certified its products, services or deliverables for use in high risk applications including medical life support, medical device, direct physical patient contact, water treatment, nuclear facilities, weapon systems, mass and air transportation control, flammable environments, or any other potentially life critical uses. Customer understands and agrees that AVX makes no assurances that the products, services or deliverables are suitable for any high-risk uses. Under no circumstances does AVX warrant or guarantee suitability for any customer design or manufacturing process.

Although all product–related warnings, cautions and notes must be observed, the customer should not assume that all safety measures are indicated or that other measures may not be required.

Polymer, Tantalum and Niobium Oxide Capacitors



Table of Contents

SECTION 1: SOLID TANTALUM & NIOBIUM OXIDE CHIP CAPACITORS

Tantalum and Niobium Oxide Products Introduction and Road Map.....	3
Resin Molded Solid Tantalum Chip, J-Lead	
TAJ – Standard & Low Profile.....	5
TAJ Series – Automotive Product Range.....	18
F92 Series – Low Profile.....	25
F93 Series.....	30
F93-AJ6 Series – Automotive Product Range.....	35
High CV Resin Molded Solid Tantalum Chip	
TLJ Series – J-Lead.....	40
TLN Series – Undertab.....	46
TLN PulseCap™ Series – High Capacitance - Undertab.....	50
F98 Series – Undertab.....	54
F98-AS1 Series – Fused Tantalum Chip - Undertab.....	58
F98-AJ6 Series – Resin-Molded Chip, High CV Facedown - Automotive Range.....	61
Low ESR Resin Molded Solid Tantalum Chip, J-Lead	
TPS Series – Standard & Low Profile.....	64
TPS Series – Automotive Product Range.....	77
F91 Series.....	85
F91-AJ6 Series – Automotive Product Range.....	89
TPM Series – Multianode, Ultra Low ESR.....	92
High Performance Resin Molded Solid Tantalum Chip	
TRJ Series – Enhanced Reliability Professional & Automotive Grade - J-Lead.....	97
F97 Series – Enhanced Reliability Professional & Automotive Grade - J-Lead.....	106
F97-HT3 Series – High Temperature (135°C max) - J-Lead.....	111
TRM Series – Enhanced Reliability Professional Grade Multianode - J-Lead.....	116
TMJ SMD S1gma™ Series – LAT* Professional Grade - J-Lead.....	121
THJ Series – High Temperature (175°C max.) - J-Lead.....	127
THJ Extended Series – High Temperature (200°C max.) - J-Lead.....	133
TACmicrochip®	
TAC Series – Standard and Low Profile TACmicrochip®.....	137
TLC Series – High CV TACmicrochip®.....	144
TPC Series – Low ESR TACmicrochip®.....	149
Conformal Coated Tantalum Chip	
F95 Series – Standard.....	154
F95 Audio Series – Optimized for Audio Applications.....	158
F72/F75 Series – Low Profile and High CV.....	161
Resin Molded OxiCap® Solid Niobium Oxide Chip, J-Lead	
NOJ Series – Standard and Low Profile OxiCap®.....	165
NLJ Series – High CV OxiCap®.....	172
NOS Series – Low ESR OxiCap®.....	176
NOM Series – Multianode Ultra-Low ESR OxiCap®.....	183

SECTION 2: SOLID CONDUCTIVE POLYMER ELECTROLYTIC CHIP CAPACITORS

TCJ Series – Standard and Low Profile - J-Lead.....	187
TCM Series – Multianode Ultra Low ESR - J-Lead.....	200
TCN Series – High CV/cc - Undertab.....	204
J-CAP™ Series – Highest Joules/cc - Undertab.....	210
F38 Series – Miniature - Undertab.....	218
TCO Series – High Temperature Automotive Polymer Chip Capacitors.....	222
TCQ Series – Automotive - J-Lead.....	226

SECTION 3: LEADED TANTALUM

Introduction

Dipped Radial Capacitors

TAP/TEP Series Wire Form Outline.....	232
TAP Series.....	233
TEP Series.....	236
TAP/TEP Series Tape & Reel.....	239

SECTION 4: TECHNICAL SUMMARY AND APPLICATION GUIDELINES

Introduction.....	241
Section 1: Electrical Characteristics And Explanation Of Terms.....	243
Section 2: A.C. Operation, Ripple Voltage And Ripple Current.....	248
Section 3: Reliability And Calculation Of Failure Rate.....	251
Section 4: Application Guidelines for Tantalum and Oxicap® Capacitors.....	254
Section 5: Terminations.....	255
Section 6: Mechanical And Thermal Properties Of Capacitors.....	256
Section 7: Epoxy Flammability.....	257
Section 8: Qualification Approval Status.....	257
Product Safety and Environmental Information Data.....	261
Tantalum & Niobium Oxide Capacitors (excluding F-series) – Tape & Reel Packaging.....	263
F-Series Capacitors – Tape & Reel Packaging.....	266

TAP/TEP TECHNICAL SUMMARY AND APPLICATION GUIDELINES

Section 1: Electrical Characteristics And Explanation Of Terms.....	267
Section 2: A.c. Operation – Ripple Voltage And Ripple Current.....	271
Section 3: Reliability And Calculation Of Failure Rate.....	272
Section 4: Application Guidelines For Tantalum Capacitors.....	275
Section 5: Mechanical And Thermal Properties, Leaded Capacitors.....	275
Questions and Answers.....	276
Software Tools.....	280
Products Listing.....	281
Available Range of Sample Kits.....	282

*LAT = Lot Acceptance Tested



The Important Information/Disclaimer is incorporated in the catalog where these specifications came from or available online at www.avx.com/disclaimer/ by reference and should be reviewed in full before placing any order.

Section 1: Solid Tantalum & Niobium Oxide Chip Capacitors

Tantalum and Niobium Oxide Products Introduction and Road Map



APPLICATIONS



AVX – FOCUS ON QUALITY

AVX is committed to Total Customer Satisfaction by meeting or exceeding expectations in product performance and product innovation while providing comprehensive technical support combined with matchless service.

AVX Corporation Goals:

- To provide world class service in the manufacture and supply of electronic components, while maintaining a positive return on investment.
- Consistently supplying product of the highest quality with exceptional service throughout the entire supply chain.
- New or improved products, processes or services will be qualified to established standards of quality and reliability.

The above objectives shall be achieved by the following codes of practice:

1. Continuous evaluation of all customer expectations, bringing to bear all AVX resources to meet their future needs.
2. Continually fostering and promoting a culture of continuous improvement through training and empowered participation of employees at all levels of the company.
3. Continuous Process Improvement using sound engineering principles to enhance existing equipment, materials and processes. This includes the application of the science of SPC focused on improving the Process Capability Index, Cpk.

All Tantalum division plants are approved to ISO 9001:2015 quality standard; IATF 16949:2016 (Automotive Quality System Requirements) and ISO 14001:2015 environmental standards. Defined series of conductive polymer, tantalum and NbO OxiCap® capacitors meet the requirements of AEC-Q200.

Plant Certifications		ISO		IATF	ESA	IECQ	OH SAS
Site	Location	9001	14001	16949	ESCC	CECC	18001
Adogawa	Japan	✓	✓	✓			
Lanskroun	Czech	✓	✓	✓	✓	✓	
San Salvador	El Salvador	✓	✓	✓			✓

Please see AVX web site www.avx.com for the latest certification status.

AVX Corporation (NYSE: AVX) with headquarters in Fountain Inn, South Carolina, USA, is a leading global supplier of passive electronic components.

AVX solid electrolytic capacitors are produced in major world regions: Lanskroun, Czech Republic (Europe), San Salvador, El Salvador (Americas) and Adogawa in Japan (Asia), giving full access to our global customers and enabling optimum service for our regional customer base. High reliability specialised tantalums are produced in AVX Biddeford, Maine, US.



Introduction

AVX Tantalum



The Tantalum division of AVX produces a wide range of solid electrolytic capacitors. Typically, the construction consists of a 1st electrode (**anode**), an insulating layer (dielectric) and a 2nd electrode (**cathode**) system.

The anode is manufactured either from pure tantalum or niobium oxide powder. **Tantalum** is an element extracted from ores found alongside tin and niobium deposits; the major sources of supply are located in Brazil, Africa and Australia.

Since December 1st, 2011, AVX has exclusively sourced the tantalum powder and wire used to manufacture its tantalum capacitors from smelters whose compliance with the Electronic Industry Code of Conduct (EICC) and the Global e-Sustainability Initiative (GeSI)

Conflict-Free Smelter program has been verified. **Niobium oxide** is a ceramic material that can be refined to the same capacitor grade powder morphology as high purity tantalum powder, enabling capacitor anode manufacture by identical processes.

The **dielectric** layer is an oxide of the anodic material – tantalum or niobium pentoxide. These oxides can be formed in very thin layers, which, combined with their unique insulating properties, enables very high and stable capacitance values to be achieved.

The **cathode** is made from manganese dioxide, a semiconducting material (for standard tantalum and niobium oxide solid electrolytic capacitors) or conductive polymer (for polymer solid electrolytic capacitors).

AVX is world wide leading Tantalum capacitor manufacturer with widest range of capacitors from smallest to large case sizes, from consumer to automotive, medical and aerospace level applications. AVX has a leading market position in all world regions. Call us first - **AVX your global partner.**

TECHNOLOGY TRENDS

Miniaturization (downsizing in both real estate and height profile) while retaining high capacitance has been the most significant driver of capacitor requirements for the latest electronic hardware designs. Solid electrolytic capacitors are one of the best technologies to offer very high capacitance value in small dimensions.

The amount of capacitance achievable in solid electrolytic capacitors is directly related to the characteristics of the powder used to manufacture the anode. Capacitance x voltage per gram (CV/g) is the measure used to define the volumetric efficiency of a powder. The following graph shows how the capability in CV/g has steadily increased over time, allowing the production of greater capacitance values within the same physical outline. These powder improvements have been achieved through close development with material suppliers. AVX are committed to driving the available technology forward, demonstrated by extended ratings continually being introduced in all technologies, including conductive polymer tantalum, TACmicrochip®, and NbO OxiCap®.

Tantalum Powder CV/g

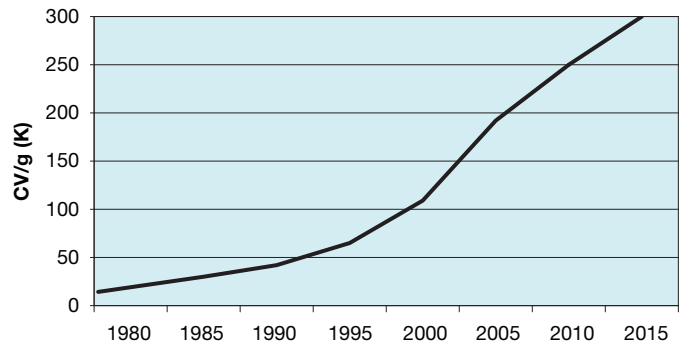

The next significant driver is equivalent series resistance (ESR) reduction. As DC-DC converter and power supply designs increase in power density, they require lower ESR output capacitors to control ripple. AVX maintains a continuous ESR improvement program to ensure low ESR capacitor capability is maintained across the widest operating voltage range to keep pace with emerging industry requirements.

*Niobium Oxide Capacitors are manufactured and sold under patent license from Cabot Corporation, Boyertown, Pennsylvania U.S.A.



Solid Electrolytic Capacitors Road Map



		Commercial	Professional & Automotive	High-Temp	CECC	COTS+*	DLA*	MIL-PRF*	Space Level*	Medical*	
SMD Conventional (MnO₂ Cathode) Tantalum Solid Electrolytic Chip Capacitors											
Standard	J-lead termination	TAJ	TAJ Automotive	F97-HT3 135°C (auto)	TAJ CECC 30801-011 30801-005			CWR11	TAJ ESCC 3012-001	T4J HRC4000	
		TAJ Low Profile	TRJ (auto) Professional								
		F93	F93-AJ6 (auto)	THJ 175°C (auto)							
	F92 Low Profile	F97 (auto)	THJ 200°C								
	Conformal	F95									
Low ESR	J-lead termination	TPS Low ESR	TPS Automotive	THJ 175°C (auto)		TBJ Low ESR	DLA 95158		TBJ SRC9000		
		F91	F91-AJ6 (auto) TRJ (auto) Low ESR								DLA 07016
Ultra Low ESR Multianode	J-lead termination	TPM Ultra Low ESR	TRM (auto)			TBM Ultra Low ESR			TBM SRC9000 TES ESCC 3012-004		
Low DCL	J-lead termination	TMJ Low DCL	TMJ S1gma™								
High CV	J-lead termination	TLJ									
		F98									
	Undertab termination	TLN Undertab									
		TLN PulseCap™									
	Conformal	F72/75									
CWR 09, 19, 29*	Standard					TAZ		CWR09 CWR19 High CV	TAZ SRC9000 CWR "T" Level	TAZ HRC5000 T4Z HRC4000	
	Low ESR					TAZ		CWR29	TAZ SRC9000 CWR "T" Level	TAZ HRC5000 T4Z HRC4000	
Fused		F98-AS1 Fused									
Modules						TCP Ultra Low ESR	DLA 09009		TCP SRC9000	TCP HRC5000	
Hermetic Package*			THH	THH 230°C		THH					
SMD Conductive Polymer Tantalum Solid Electrolytic Chip Capacitors											
Standard	J-lead termination	TCJ	TCQ Automotive	TCO 150°C (auto)		TCB			TCS ESCC 3012-006		
Ultra low ESR Multianode		TCM Multianode				TCS					
High Energy	Undertab termination	J-CAP™ TCN									
Low Profile		TCN Undertab									
Miniature		F38									
Hermetic Package*			TCH			TCH			TCH		

* see High Reliability Tantalum Catalog

Note: For specific requirements and questions please contact AVX

under development



The Important Information/Disclaimer is incorporated in the catalog where these specifications came from or available online at www.avx.com/disclaimer/ by reference and should be reviewed in full before placing any order.

Solid Electrolytic Capacitors Road Map

		Commercial	Professional & Automotive	High-Temp	CECC	COTS+*	DLA*	MIL-PRF*	Space Level*	Medical*
TACmicrochip® SMD Tantalum Solid Electrolytic Chip Capacitors										
Standard	microchip leadless design	TAC				TBC		CWR15	TBC SRC9000	TBC HRC5000 TBC HRC6000 T4C HRC4000
High CV		TLC								
Low ESR		TPC								
OxiCap® SMD Niobium Oxide Solid Electrolytic Chip Capacitors										
Standard	J-head termination	NOJ	NOJ							
Low ESR		NLJ								
Low ESR Multianode		NOM	NOM							
Radial Leaded Tantalum Solid Electrolytic Capacitors (Resin Dipped)										
Resin Dipped	Radial leads	TAP/TEP Radial			TAP CECC 30201-032					

Wet Electrolytic Tantalum Capacitors

Tantalum Wet Electrolytic Capacitors										
Wet*	Axial leads	TWD	TWA-Y 200°C	TWA	TWA	DLA 93026	M39006	TWC SRW9000		
			TWC-Y 200°C		TWS	DLA 13017	TWS SRW9000			
			TWA-X 230°C		TWM					
Wet* Modules										

*see High Reliability Tantalum Catalog

Note: For specific requirements and questions please contact AVX

AVX SMD SOLID ELECTROLYTIC CAPACITORS SERIES AND CONSTRUCTIONS

AVX SMD solid electrolytic capacitors family consists of two types of anode materials (standard Tantalum and unique Niobium Oxide) and two types of cathode materials (conventional MnO₂ and Conductive polymer) in several styles of capacitor constructions.

AVX also offers wide range of **traditional leaded solid electrolytic tantalum capacitors and leaded Wet Electrolytic tantalums.**

Case sizes of AVX Capacitors are denoted by single letter or symbol in the part number. Please note that the case size letter is always related to the specific product series. For more details please look at the specific series information, or general guides related or contact AVX.

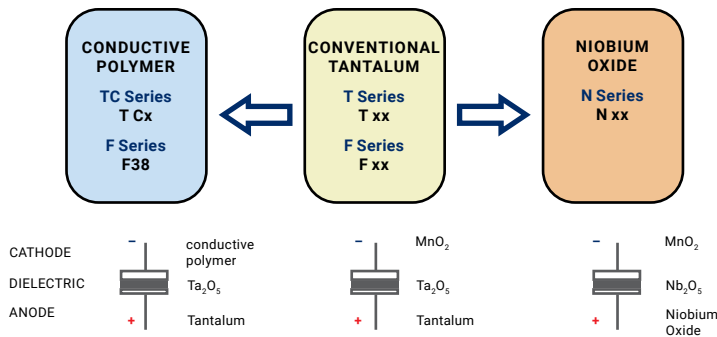

FIVE CAPACITOR CONSTRUCTION STYLES

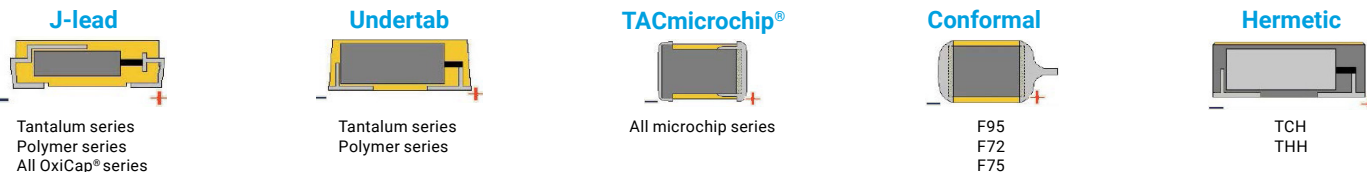

TAJ Series

Standard and Low Profile Tantalum Capacitors

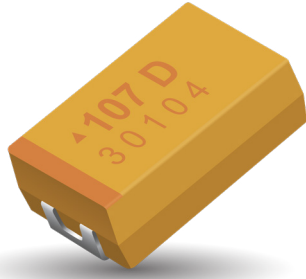

FEATURES

- General Purpose SMT Chip Tantalum Series
- 100% Surge Current Tested
- 17 Case Sizes Available, Standard and Low Profile Down to 1mm Maximum Height
- CV Range: 0.10 - 2200 μ F / 2.5 - 50V
- J-Lead Construction

APPLICATIONS

- General Low Power DC/DC and LDO
- Entertainment / Infotainment Systems
- Height Restricted Design

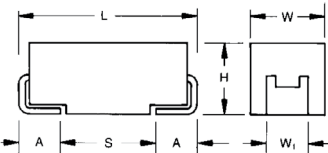

MARKING

A, B, C, D, E, F, H, K, S, T, U, V, W, X, Y CASE

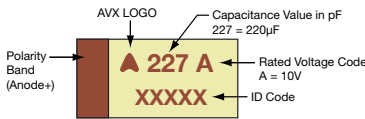

P, R CASE

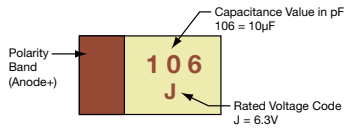

HOW TO ORDER

TAJ	C	106	M	035	R	NJ	-
Type	Case Size See table above	Capacitance Code pF code: 1st two digits represent significant figures 3rd digit represents multiplier (number of zeros to follow)	Tolerance K = $\pm 10\%$ M = $\pm 20\%$	Rated DC Voltage 002 = 2.5Vdc 004 = 4Vdc 006 = 6.3Vdc 010 = 10Vdc 016 = 16Vdc 020 = 20Vdc 025 = 25Vdc 035 = 35Vdc 050 = 50Vdc	Packaging R = Pure Tin 7" Reel S = Pure Tin 13" Reel A = Gold Plating 7" Reel B = Gold Plating 13" Reel H = Tin Lead 7" Reel K = Tin Lead 13" Reel H, K = Non RoHS A, B, H, K = please contact manufacturer	Specification Suffix NJ = Standard Suffix	Additional characters may be added for special requirements V = Dry pack Option (selected ratings only)

TECHNICAL SPECIFICATIONS

Technical Data:	All technical data relate to an ambient temperature of +25°C										
Capacitance Range:	0.10 μ F to 2200 μ F										
Capacitance Tolerance:	$\pm 10\%$; $\pm 20\%$										
Rated Voltage (V_R)	$\leq +85^\circ\text{C}$:	2.5	4	6.3	10	16	20	25	35	50	
Category Voltage (V_C)	$\leq +125^\circ\text{C}$:	1.7	2.7	4	7	10	13	17	23	33	
Surge Voltage (V_S)	$\leq +85^\circ\text{C}$:	3.3	5.2	8	13	20	26	32	46	65	
Surge Voltage (V_S)	$\leq +125^\circ\text{C}$:	2.2	3.4	5	8	13	16	20	28	40	
Temperature Range:	-55°C to +125°C										
Reliability:	1% per 1000 hours at 85°C, V_R with 0.1 Ω /V series impedance, 60% confidence level										
Qualification:	CECC 30801 - 005 issue 2 EIA 535BAAC for standard case sizes										
Termination Finished:	Sn Plating (standard), Gold and SnPb Plating upon request										
	For AEC-Q200 availability, please contact AVX										

STANDARD CASE DIMENSIONS:

millimeters (inches)

Code	EIA Code	EIA Metric	L ± 0.20 (0.008)	W ± 0.20 (0.008) -0.10 (0.004)	H ± 0.20 (0.008) -0.10 (0.004)	W ± 0.20 (0.008)	A ± 0.30 (0.012) -0.20 (0.008)	S Min.
A	1206	3216-18	3.20 (0.126)	1.60 (0.063)	1.60 (0.063)	1.20 (0.047)	0.80 (0.031)	1.10 (0.043)
B	1210	3528-21	3.50 (0.138)	2.80 (0.110)	1.90 (0.075)	2.20 (0.087)	0.80 (0.031)	1.40 (0.055)
C	2312	6032-28	6.00 (0.236)	3.20 (0.126)	2.60 (0.102)	2.20 (0.087)	1.30 (0.051)	2.90 (0.114)
D	2917	7343-31	7.30 (0.287)	4.30 (0.169)	4.30 (0.169)	2.40 (0.094)	1.30 (0.051)	4.40 (0.173)
E	2917	7343-43	7.30 (0.287)	4.30 (0.169)	4.10 (0.162)	2.40 (0.094)	1.30 (0.051)	4.40 (0.173)
U	2924	7361-43	7.30 (0.287)	6.10 (0.240)	4.10 (0.162)	3.10 (0.122)	1.30 (0.051)	4.40 (0.173)
V	2924	7361-38	7.30 (0.287)	6.10 (0.240)	3.55 (0.140)	3.10 (0.122)	1.30 (0.051)	4.40 (0.173)

W₁ dimension applies to the termination width for A dimensional area only.

LOW PROFILE CASE DIMENSIONS:

millimeters (inches)

Code	EIA Code	EIA Metric	L ± 0.20 (0.008)	W ± 0.20 (0.008) -0.10 (0.004)	H Max.	W ₁ ± 0.20 (0.008)	A ± 0.30 (0.012) -0.20 (0.008)	S Min.
F	2312	6032-20	6.00 (0.236)	3.20 (0.126)	2.00 (0.079)	2.20 (0.087)	1.30 (0.051)	2.90 (0.114)
H	1210	3528-15	3.50 (0.138)	2.80 (0.110)	1.50 (0.059)	2.20 (0.087)	0.80 (0.031)	1.40 (0.055)
K	1206	3216-10	3.20 (0.126)	1.60 (0.063)	1.00 (0.039)	1.20 (0.047)	0.80 (0.031)	1.10 (0.043)
P	0805	2012-15	2.05 (0.081)	1.35 (0.053)	1.50 (0.059)	1.00 ± 0.10 (0.039 ± 0.004)	0.50 (0.020)	0.85 (0.033)
R	0805	2012-12	2.05 (0.081)	1.30 (0.051)	1.20 (0.047)	1.00 ± 0.10 (0.039 ± 0.004)	0.50 (0.020)	0.85 (0.033)
S	1206	3216-12	3.20 (0.126)	1.60 (0.063)	1.20 (0.047)	1.20 (0.047)	0.80 (0.031)	1.10 (0.043)
T	1210	3528-12	3.50 (0.138)	2.80 (0.110)	1.20 (0.047)	2.20 (0.087)	0.80 (0.031)	1.40 (0.055)
W	2312	6032-15	6.00 (0.236)	3.20 (0.126)	1.50 (0.059)	2.20 (0.087)	1.30 (0.051)	2.90 (0.114)
X	2917	7343-15	7.30 (0.287)	4.30 (0.169)	1.50 (0.059)	2.40 (0.094)	1.30 (0.051)	4.40 (0.173)
Y	2917	7343-20	7.30 (0.287)	4.30 (0.169)	2.00 (0.079)	2.40 (0.094)	1.30 (0.051)	4.40 (0.173)

W₁ dimension applies to the termination width for A dimensional area only.

STANDARD TANTALUMS CAPACITANCE AND RATED VOLTAGE RANGE (LETTER DENOTES CASE SIZE)

Capacitance		Rated voltage DC (V _R) to 85°C								
μF	Code	2.5V (e)	4V (G)	6.3V (J)	10V (A)	16V (C)	20V (D)	25V (E)	35V (V)	50V (T)
0.10	104								A	A
0.15	154								A	A/B
0.22	224								A	A/B
0.33	334								A	A/B
0.47	474							A	A/B	A/B/C
0.68	684							A	A/B	A/B/C
1.0	105					A	A	A	A/B	A/B/C
1.5	155				A	A	A	A/B	A/B/C	B/C/D
2.2	225			A	A	A/B	A/B	A/B	A/B/C	B/C/D
3.3	335			A	A	A/B	A/B	A/B/C	B/C	C/D
4.7	475			A	A/B	A/B	A/B/C	A/B/C	B/C/D	C/D
6.8	685			A/B	A/B	A/B/C	A/B/C	B/C	C/D	C/D
10	106		A	A/B	A/B/C	A/B/C	B/C	B/C/D	C/D/E	D/E/V
15	156		A	A/B	A/B/C	A/B/C	B/C/D	C/D	C/D	D/E/V
22	226		A	A/B/C	A/B/C	A ^(M) /B/C/D	B/C/D	C/D	D/E	V
33	336	A	A/B	A/B/C	A/B/C/D	B/C/D	C/D	C/D/E	D/E/V	
47	476	A	A/B	A/B/C/D	B/C/D	C/D	C/D/E	D/E	D/E/V	
68	686	A	A/B	B/C/D	B/C/D	C/D	C ^(M) /D/E	D/E/V	V	
100	107	A/B	A/B/C	B/C/D	B/C/D/E	C/D/E	D/E/V	E/V		
150	157	B	B/C	B ^(M) /C/D	C/D/E	D/E/V	E/V	V ^(M)		
220	227	B/D	B/C/D	C/D/E	C/D/E	D ^(M) /E/V				
330	337	D	C/D	C/D/E	D/E/V	E ^(M)				
470	477	C/D	C/D/E	D/E/V	E/U/V					
680	687	C/D/E	D/E	D/E/V	E ^(M) /V ^(M)					
1000	108	D ^(M) /E	D/E/V	E ^(M) /V ^(M)						
1500	158	D/E/V ^(M)	E/V ^(M)							
2200	228	V ^(M)								

LOW PROFILE TANTALUMS CAPACITANCE AND RATED VOLTAGE RANGE (LETTER DENOTES CASE SIZE)

Capacitance		Rated voltage DC (V _R) to 85°C								
μF	Code	2.5V (e)	4V (G)	6.3V (J)	10V (A)	16V (C)	20V (D)	25V (E)	35V (V)	50V (T)
0.10	104						R/S		R/S	S
0.15	154						R/S	R	R/S	S
0.22	224						R/S	R	R/S	P/R/S
0.33	334						R/S	R	R/S	P/R ^(M) /S/T
0.47	474						R/S	R/S	R/S/T	S/T
0.68	684					R/S	R/S/T	R/S	P/S/T	
1.0	105				R/S	R/S/T	R/S/T	P/R/S	P/S/T	W
1.5	155			R/S	R/S	R/S	P/R/S/T	P/S/T	T	W
2.2	225		R/S	R/S	R/S	R/S/T	P/R/S/T	T	T	W
3.3	335		R/S	R/S	K/R/S/T	R/S/T	T	T/W	W	Y
4.7	475	R	R/S	R/S/T	R/S/T	K/P/S/T	T	T/W	W	X/Y
6.8	685	R	R/S/T	R/S/T	P/R/S/T	S/T	T	W	Y	Y
10	106	R/S	R/S/T	P/R/S/T	K/P/R ^(M) /S/T	T/W	W	W	X/Y	
15	156	R	R/S/T	K/P/R/S/T	S/T/W	T ^(M) /W	W	Y	Y	
22	226	P/R	K/P/R/S/T	K/P ^(M) /S/T/W	T/W	W	W/Y	F/Y	Y	
33	336	K/P/S	K/P ^(M) /S/T/W	T/W	W	W/Y	X/Y	F/Y		
47	476	P ^(M) /S	T/W	T/W	H/W/Y	W/X/Y	X/Y	Y		
68	686	T	T/W	W	W/Y	F/X/Y	Y			
100	107	T/W	T ^(M) /W	W/Y	W/X/Y	F ^(M) /Y				
150	157	TM/W	W/Y	W/X/Y	F/XM/Y	Y ^(M)				
220	227	W/Y	W/X/Y	F/X/Y	Y					
330	337	W ^(M) /Y	F/X/Y	Y						
470	477	F/Y	Y	Y						
680	687	Y	Y ^(M)							
1000	108	Y ^(M)								

Released ratings ^(M tolerance only)

Note: Voltage ratings are minimum values. AVX reserves the right to supply higher voltage ratings in the same case size, to the same reliability standards.

TAJ Series

Standard and Low Profile Tantalum Capacitors



RATINGS & PART NUMBER REFERENCE

AVX Part No.	Case Size	Capacitance (µF)	Rated Voltage (V)	Rated Temperature (°C)	Category Voltage (V)	Category Temperature (°C)	DCL Max. (µA)	DF Max. (%)	ESR Max. @ 100kHz (Ω)	100kHz RMS Current (mA)			MSL
										25°C	85°C	125°C	
2.5 Volt @ 85°C													
TAJR475*002#NJ	R	4.7	2.5	85	1.7	125	0.5	6	20	52	47	21	1
TAJR685*002#NJ	R	6.8	2.5	85	1.7	125	0.5	6	20	52	47	21	1
TAJR106*002#NJ	R	10	2.5	85	1.7	125	0.5	8	4.5	111	99	44	1
TAJS106*002#NJ	S	10	2.5	85	1.7	125	0.5	6	8	90	81	36	1
TAJR156*002#NJ	R	15	2.5	85	1.7	125	0.5	8	4.1	116	104	46	1
TAJP226*002#NJ	P	22	2.5	85	1.7	125	0.5	8	3.5	131	118	52	1
TAJR226*002#NJ	R	22	2.5	85	1.7	125	0.5	8	3.8	120	108	48	1
TAJA336*002#NJ	A	33	2.5	85	1.7	125	0.8	8	1.7	210	189	84	1
TAJK336*002#NJ	K	33	2.5	85	1.7	125	0.8	8	1.7	196	176	78	1
TAJP336*002#NJ	P	33	2.5	85	1.7	125	0.7	8	3.5	131	118	52	1
TAJS336*002#NJ	S	33	2.5	85	1.7	125	0.7	8	1.5	208	187	83	1
TAJA476*002#NJ	A	47	2.5	85	1.7	125	0.9	6	3	158	142	63	1
TAJP476M002#NJ	P	47	2.5	85	1.7	125	1.2	12	3.2	137	123	55	1
TAJS476*002#NJ	S	47	2.5	85	1.7	125	1.2	8	1.6	202	181	81	1
TAJA686*002#NJ	A	68	2.5	85	1.7	125	1.4	8	1.5	224	201	89	1
TAJT686*002#NJ	T	68	2.5	85	1.7	125	1.4	8	1.5	231	208	92	1
TAJA107*002#NJ	A	100	2.5	85	1.7	125	2.5	30	1.4	231	208	93	1
TAJB107*002#NJ	B	100	2.5	85	1.7	125	2.5	8	1.4	246	222	99	1
TAJT107*002#NJ	T	100	2.5	85	1.7	125	2.5	15	1.3	248	223	99	1
TAJW107*002#NJ	W	100	2.5	85	1.7	125	2.5	8	0.4	474	427	190	1
TAJB157*002#NJ	B	150	2.5	85	1.7	125	3	10	1.6	230	207	92	1
TAJT157M002#NJ	T	150	2.5	85	1.7	125	3.8	18	1.2	258	232	103	1
TAJW157*002#NJ	W	150	2.5	85	1.7	125	3.8	8	0.3	548	493	219	1
TAJB227*002#NJ	B	220	2.5	85	1.7	125	4.4	16	1.6	230	207	92	1
TAJD227*002#NJ	D	220	2.5	85	1.7	125	5.5	8	0.3	707	636	283	1
TAJW227*002#NJ	W	220	2.5	85	1.7	125	5.5	8	0.3	548	493	219	1
TAJY227*002#NJ	Y	220	2.5	85	1.7	125	5.5	8	0.3	645	581	258	1 ¹⁾
TAJD337*002#NJ	D	330	2.5	85	1.7	125	8.2	8	0.3	707	636	283	1
TAJW337M002#NJ	W	330	2.5	85	1.7	125	8.2	12	0.3	548	493	219	1
TAJY337*002#NJ	Y	330	2.5	85	1.7	125	8.2	8	0.3	645	581	258	1 ¹⁾
TAJC477*002#NJ	C	470	2.5	85	1.7	125	9.4	12	0.2	742	667	297	1
TAJD477*002#NJ	D	470	2.5	85	1.7	125	11.6	8	0.2	866	779	346	1
TAJF477*002#NJ	F	470	2.5	85	1.7	125	11.8	12	0.3	577	520	231	1
TAJY477*002#NJ	Y	470	2.5	85	1.7	125	11	12	0.2	791	712	316	1 ¹⁾
TAJC687*002#NJ	C	680	2.5	85	1.7	125	17	18	0.2	742	667	297	1
TAJD687*002#NJ	D	680	2.5	85	1.7	125	17	16	0.2	866	779	346	1
TAJE687*002#NJ	E	680	2.5	85	1.7	125	17	10	0.2	908	817	363	1 ¹⁾
TAJY687*002#NJ	Y	680	2.5	85	1.7	125	17	12	0.2	791	712	316	1 ¹⁾
TAJD108M002#NJ	D	1000	2.5	85	1.7	125	25	20	0.2	866	779	346	1
TAJE108*002#NJ	E	1000	2.5	85	1.7	125	25	14	0.4	642	578	257	1 ¹⁾
TAJY108M002#NJ	Y	1000	2.5	85	1.7	125	25	30	0.2	791	712	316	1 ¹⁾
TAJD158*002#NJ	D	1500	2.5	85	1.7	125	37.5	60	0.2	866	779	346	1
TAJE158*002#NJ	E	1500	2.5	85	1.7	125	37	20	0.2	908	817	363	1 ¹⁾
TAJV158M002#NJ	V	1500	2.5	85	1.7	125	30	20	0.2	1118	1006	447	1 ¹⁾
TAJV228M002#NJ	V	2200	2.5	85	1.7	125	55	50	0.2	1118	1006	447	1 ¹⁾
4 Volt @ 85°C													
TAJR225*004#NJ	R	2.2	4	85	2.7	125	0.5	6	25	47	42	19	1
TAJS225*004#NJ	S	2.2	4	85	2.7	125	0.5	6	25	51	46	20	1
TAJR335*004#NJ	R	3.3	4	85	2.7	125	0.5	6	20	52	47	21	1
TAJS335*004#NJ	S	3.3	4	85	2.7	125	0.5	6	18	60	54	24	1
TAJR475*004#NJ	R	4.7	4	85	2.7	125	0.5	6	12	68	61	27	1
TAJS475*004#NJ	S	4.7	4	85	2.7	125	0.5	6	10	81	73	32	1
TAJR685*004#NJ	R	6.8	4	85	2.7	125	0.5	6	5.2	103	93	41	1
TAJS685*004#NJ	S	6.8	4	85	2.7	125	0.5	6	8	90	81	36	1
TAJT685*004#NJ	T	6.8	4	85	2.7	125	0.5	6	6	115	104	46	1
TAJA106*004#NJ	A	10	4	85	2.7	125	0.5	6	6	112	101	45	1
TAJR106*004#NJ	R	10	4	85	2.7	125	0.5	6	7	89	80	35	1
TAJS106*004#NJ	S	10	4	85	2.7	125	0.5	6	6	104	94	42	1
TAJT106*004#NJ	T	10	4	85	2.7	125	0.5	6	5	126	114	51	1
TAJA156*004#NJ	A	15	4	85	2.7	125	0.6	6	4	137	123	55	1
TAJR156*004#NJ	R	15	4	85	2.7	125	0.6	8	4	117	106	47	1
TAJS156*004#NJ	S	15	4	85	2.7	125	0.6	8	4	127	115	51	1
TAJT156*004#NJ	T	15	4	85	2.7	125	0.6	6	2	200	180	80	1
TAJA226*004#NJ	A	22	4	85	2.7	125	0.9	6	3.5	146	132	59	1
TAJK226*004#NJ	K	22	4	85	2.7	125	0.9	8	1.8	190	171	76	1
TAJP226*004#NJ	P	22	4	85	2.7	125	0.9	8	4	122	110	49	1
TAJR226*004#NJ	R	22	4	85	2.7	125	0.9	8	3.8	120	108	48	1
TAJS226*004#NJ	S	22	4	85	2.7	125	0.9	8	3.5	136	123	55	1
TAJT226*004#NJ	T	22	4	85	2.7	125	0.9	6	1.9	205	185	82	1
TAJA336*004#NJ	A	33	4	85	2.7	125	1.3	6	3	158	142	63	1



The Important Information/Disclaimer is incorporated in the catalog where these specifications came from or available online at www.avx.com/disclaimer/ by reference and should be reviewed in full before placing any order.

TAJ Series

Standard and Low Profile Tantalum Capacitors



RATINGS & PART NUMBER REFERENCE

AVX Part No.	Case Size	Capacitance (µF)	Rated Voltage (V)	Rated Temperature (°C)	Category Voltage (V)	Category Temperature (°C)	DCL Max. (µA)	DF Max. (%)	ESR Max. @ 100kHz (Ω)	100kHz RMS Current (mA)			MSL
										25°C	85°C	125°C	
TAJB336*004#NJ	B	33	4	85	2.7	125	1.3	6	2.8	174	157	70	1
TAJK336*004#NJ	K	33	4	85	2.7	125	1.3	10	1.7	196	176	78	1
TAJP336M004#NJ	P	33	4	85	2.7	125	1.3	8	2.8	146	132	59	1
TAJS336*004#NJ	S	33	4	85	2.7	125	1.3	8	1.7	196	176	78	1
TAJT336*004#NJ	T	33	4	85	2.7	125	1.3	6	1.7	217	195	87	1
TAJW336*004#NJ	W	33	4	85	2.7	125	1.3	6	0.6	387	349	155	1
TAJA476*004#NJ	A	47	4	85	2.7	125	1.9	8	2.6	170	153	68	1
TAJB476*004#NJ	B	47	4	85	2.7	125	1.9	6	2.4	188	169	75	1
TAJT476*004#NJ	T	47	4	85	2.7	125	1.9	10	1.6	224	201	89	1
TAJW476*004#NJ	W	47	4	85	2.7	125	1.9	6	0.5	424	382	170	1
TAJA686*004#NJ	A	68	4	85	2.7	125	2.7	10	1.5	224	201	89	1
TAJB686*004#NJ	B	68	4	85	2.7	125	2.7	6	1.8	217	196	87	1
TAJT686*004#NJ	T	68	4	85	2.7	125	2.7	15	1.5	231	208	92	1
TAJW686*004#NJ	W	68	4	85	2.7	125	2.7	6	0.4	474	427	190	1
TAJA107*004#NJ	A	100	4	85	2.7	125	4	30	1.4	231	208	93	1
TAJB107*004#NJ	B	100	4	85	2.7	125	4	8	0.9	307	277	123	1
TAJC107*004#NJ	C	100	4	85	2.7	125	4	6	1.3	291	262	116	1
TAJT107M004#NJ	T	100	4	85	2.7	125	4	14	1.4	239	215	96	1
TAJW107*004#NJ	W	100	4	85	2.7	125	4	6	0.4	474	427	190	1
TAJB157*004#NJ	B	150	4	85	2.7	125	6	10	1.5	238	214	95	1
TAJC157*004#NJ	C	150	4	85	2.7	125	6	6	0.3	606	545	242	1
TAJW157*004#NJ	W	150	4	85	2.7	125	6	6	0.5	424	382	170	1
TAJY157*004#NJ	Y	150	4	85	2.7	125	6	6	0.4	559	503	224	1 ¹⁾
TAJB227*004#NJ	B	220	4	85	2.7	125	8.8	12	1.1	278	250	111	1
TAJC227*004#NJ	C	220	4	85	2.7	125	8.8	8	1.2	303	272	121	1
TAJD227*004#NJ	D	220	4	85	2.7	125	8.8	8	0.9	408	367	163	1
TAJW227*004#NJ	W	220	4	85	2.7	125	8.8	8	0.3	548	493	219	1
TAJX227*004#NJ	X	220	4	85	2.7	125	8.8	8	0.3	577	520	231	1 ¹⁾
TAJY227*004#NJ	Y	220	4	85	2.7	125	8.8	8	0.3	645	581	258	1 ¹⁾
TAJC337*004#NJ	C	330	4	85	2.7	125	13.2	8	0.3	606	545	242	1
TAJD337*004#NJ	D	330	4	85	2.7	125	13.2	8	0.9	408	367	163	1
TAJF337*004#NJ	F	330	4	85	2.7	125	13.2	10	0.3	577	520	231	1
TAJX337*004#NJ	X	330	4	85	2.7	125	13.2	8	0.3	577	520	231	1 ¹⁾
TAJY337*004#NJ	Y	330	4	85	2.7	125	13.2	12	0.4	559	503	224	1 ¹⁾
TAJC477*004#NJ	C	470	4	85	2.7	125	18.8	14	0.3	606	545	242	1
TAJD477*004#NJ	D	470	4	85	2.7	125	18.8	12	0.9	408	367	163	1
TAJE477*004#NJ	E	470	4	85	2.7	125	18.8	10	0.5	574	517	230	1 ¹⁾
TAJY477*004#NJ	Y	470	4	85	2.7	125	18.8	14	0.4	559	503	224	1 ¹⁾
TAJD687*004#NJ	D	680	4	85	2.7	125	27.2	14	0.5	548	493	219	1
TAJE687*004#NJ	E	680	4	85	2.7	125	27.2	10	0.9	428	385	171	1 ¹⁾
TAJY687M004#NJ	Y	680	4	85	2.7	125	27.2	25	0.2	791	712	316	1 ¹⁾
TAJD108*004#NJ	D	1000	4	85	2.7	125	40	60	0.2	866	779	346	1
TAJE108*004#NJ	E	1000	4	85	2.7	125	40	14	0.4	642	578	257	1 ¹⁾
TAJV108*004#NJ	V	1000	4	85	2.7	125	40	16	0.2	1118	1006	447	1 ¹⁾
TAJE158*004#NJ	E	1500	4	85	2.7	125	60	30	0.2	908	817	363	1 ¹⁾
TAJV158M004#NJ	V	1500	4	85	2.7	125	60	30	0.2	1118	1006	447	1 ¹⁾
6.3 Volt @ 85°C													
TAJR155*006#NJ	R	1.5	6.3	85	4	125	0.5	6	25	47	42	19	1
TAJS155*006#NJ	S	1.5	6.3	85	4	125	0.5	6	25	51	46	20	1
TAJA225*006#NJ	A	2.2	6.3	85	4	125	0.5	6	9	91	82	37	1
TAJR225*006#NJ	R	2.2	6.3	85	4	125	0.5	6	20	52	47	21	1
TAJS225*006#NJ	S	2.2	6.3	85	4	125	0.5	6	18	60	54	24	1
TAJA335*006#NJ	A	3.3	6.3	85	4	125	0.5	6	7	104	93	41	1
TAJR335*006#NJ	R	3.3	6.3	85	4	125	0.5	6	12	68	61	27	1
TAJS335*006#NJ	S	3.3	6.3	85	4	125	0.5	6	9	85	76	34	1
TAJA475*006#NJ	A	4.7	6.3	85	4	125	0.5	6	6	112	101	45	1
TAJR475*006#NJ	R	4.7	6.3	85	4	125	0.5	6	7	89	80	35	1
TAJS475*006#NJ	S	4.7	6.3	85	4	125	0.5	6	7.5	93	84	37	1
TAJT475*006#NJ	T	4.7	6.3	85	4	125	0.5	6	6	115	104	46	1
TAJA685*006#NJ	A	6.8	6.3	85	4	125	0.5	6	5	122	110	49	1
TAJB685*006#NJ	B	6.8	6.3	85	4	125	0.6	6	5	130	117	52	1
TAJR685*006#NJ	R	6.8	6.3	85	4	125	0.5	8	7	89	80	35	1
TAJS685*006#NJ	S	6.8	6.3	85	4	125	0.5	6	2.6	158	142	63	1
TAJT685*006#NJ	T	6.8	6.3	85	4	125	0.5	6	5	126	114	51	1
TAJA106*006#NJ	A	10	6.3	85	4	125	0.6	6	4	137	123	55	1
TAJB106*006#NJ	B	10	6.3	85	4	125	0.6	6	3	168	151	67	1
TAJP106*006#NJ	P	10	6.3	85	4	125	0.6	8	6	100	90	40	1
TAJR106*006#NJ	R	10	6.3	85	4	125	0.6	8	6	96	86	38	1
TAJS106*006#NJ	S	10	6.3	85	4	125	0.6	8	4	127	115	51	1
TAJT106*006#NJ	T	10	6.3	85	4	125	0.6	6	4	141	127	57	1
TAJA156*006#NJ	A	15	6.3	85	4	125	0.9	6	3.5	146	132	59	1



TAJ Series

Standard and Low Profile Tantalum Capacitors



RATINGS & PART NUMBER REFERENCE

AVX Part No.	Case Size	Capacitance (µF)	Rated Voltage (V)	Rated Temperature (°C)	Category Voltage (V)	Category Temperature (°C)	DCL Max. (µA)	DF Max. (%)	ESR Max. @ 100kHz (Ω)	100kHz RMS Current (mA)			MSL
										25°C	85°C	125°C	
TAJB156*006#NJ	B	15	6.3	85	4	125	0.9	6	2	206	186	82	1
TAJK156*006#NJ	K	15	6.3	85	4	125	0.9	6	2	180	162	72	1
TAJP156*006#NJ	P	15	6.3	85	4	125	0.9	8	3.5	131	118	52	1
TAJR156*006#NJ	R	15	6.3	85	4	125	0.9	8	4.1	116	104	46	1
TAJS156*006#NJ	S	15	6.3	85	4	125	0.9	8	3.5	136	123	55	1
TAJT156*006#NJ	T	15	6.3	85	4	125	0.9	6	3.5	151	136	60	1
TAJA226*006#NJ	A	22	6.3	85	4	125	1.4	6	3	158	142	63	1
TAJB226*006#NJ	B	22	6.3	85	4	125	1.4	6	2.5	184	166	74	1
TAJC226*006#NJ	C	22	6.3	85	4	125	1.4	6	2	235	211	94	1
TAJK226*006#NJ	K	22	6.3	85	4	125	1.3	10	1.8	190	171	76	1
TAJP226*006#NJ	P	22	6.3	85	4	125	1.3	8	3.3	135	121	54	1
TAJS226*006#NJ	S	22	6.3	85	4	125	1.3	10	1.8	190	171	76	1
TAJT226*006#NJ	T	22	6.3	85	4	125	1.4	8	2.5	179	161	72	1
TAJW226*006#NJ	W	22	6.3	85	4	125	1.3	6	0.6	387	349	155	1
TAJA336*006#NJ	A	33	6.3	85	4	125	2.1	8	2.2	185	166	74	1
TAJB336*006#NJ	B	33	6.3	85	4	125	2.1	6	2.2	197	177	79	1
TAJC336*006#NJ	C	33	6.3	85	4	125	2.1	6	1.8	247	222	99	1
TAJT336*006#NJ	T	33	6.3	85	4	125	2.1	10	2.5	179	161	72	1
TAJW336*006#NJ	W	33	6.3	85	4	125	2	6	0.5	424	382	170	1
TAJA476*006#NJ	A	47	6.3	85	4	125	2.8	10	1.6	217	195	87	1
TAJB476*006#NJ	B	47	6.3	85	4	125	3	6	2	206	186	82	1
TAJC476*006#NJ	C	47	6.3	85	4	125	3	6	1.6	262	236	105	1
TAJD476*006#NJ	D	47	6.3	85	4	125	3	6	1.1	369	332	148	1
TAJT476*006#NJ	T	47	6.3	85	4	125	2.8	10	1.6	224	201	89	1
TAJW476*006#NJ	W	47	6.3	85	4	125	2.8	6	0.5	424	382	170	1
TAJB686*006#NJ	B	68	6.3	85	4	125	4	8	0.9	307	277	123	1
TAJC686*006#NJ	C	68	6.3	85	4	125	4.3	6	1.5	271	244	108	1
TAJD686*006#NJ	D	68	6.3	85	4	125	4.3	6	0.9	408	367	163	1
TAJW686*006#NJ	W	68	6.3	85	4	125	4.3	6	1.5	245	220	98	1
TAJB107*006#NJ	B	100	6.3	85	4	125	6.3	10	1.7	224	201	89	1
TAJC107*006#NJ	C	100	6.3	85	4	125	6.3	6	0.9	350	315	140	1
TAJD107*006#NJ	D	100	6.3	85	4	125	6.3	6	0.9	408	367	163	1
TAJW107*006#NJ	W	100	6.3	85	4	125	6.3	6	0.9	316	285	126	1
TAJY107*006#NJ	Y	100	6.3	85	4	125	6.3	6	0.7	423	380	169	1 ¹⁾
TAJB157*006#NJ	B	150	6.3	85	4	125	9.5	10	1.2	266	240	106	1
TAJC157*006#NJ	C	150	6.3	85	4	125	9.5	6	1.3	291	262	116	1
TAJD157*006#NJ	D	150	6.3	85	4	125	9.5	6	0.9	408	367	163	1
TAJW157*006#NJ	W	150	6.3	85	4	125	9	8	0.3	548	493	219	1
TAJX157*006#NJ	X	150	6.3	85	4	125	9	6	0.4	500	450	200	1 ¹⁾
TAJY157*006#NJ	Y	150	6.3	85	4	125	9.5	6	0.4	559	503	224	1 ¹⁾
TAJC227*006#NJ	C	220	6.3	85	4	125	13.9	8	1.2	303	272	121	1
TAJD227*006#NJ	D	220	6.3	85	4	125	13.9	8	0.4	612	551	245	1
TAJE227*006#NJ	E	220	6.3	85	4	125	13.9	8	0.4	642	578	257	1 ¹⁾
TAJF227*006#NJ	F	220	6.3	85	4	125	13.2	10	0.3	577	520	231	1
TAJX227*006#NJ	X	220	6.3	85	4	125	13.2	8	0.3	577	520	231	1 ¹⁾
TAJY227*006#NJ	Y	220	6.3	85	4	125	13.9	8	0.7	423	380	169	1 ¹⁾
TAJC337*006#NJ	C	330	6.3	85	4	125	19.8	12	0.5	469	422	188	1
TAJD337*006#NJ	D	330	6.3	85	4	125	20.8	8	0.4	612	551	245	1
TAJE337*006#NJ	E	330	6.3	85	4	125	20.8	8	0.4	642	578	257	1 ¹⁾
TAJY337*006#NJ	Y	330	6.3	85	4	125	20.8	12	0.4	559	503	224	1 ¹⁾
TAJD477*006#NJ	D	470	6.3	85	4	125	28	12	0.4	612	551	245	1
TAJE477*006#NJ	E	470	6.3	85	4	125	28	10	0.4	642	578	257	1 ¹⁾
TAJV477*006#NJ	V	470	6.3	85	4	125	28	10	0.4	791	712	316	1 ¹⁾
TAJY477*006#NJ	Y	470	6.3	85	4	125	28.2	20	0.2	791	712	316	1 ¹⁾
TAJD687*006#NJ	D	680	6.3	85	4	125	40.8	20	0.5	548	493	219	3
TAJE687*006#NJ	E	680	6.3	85	4	125	42.8	10	0.5	574	517	230	1 ¹⁾
TAJV687*006#NJ	V	680	6.3	85	4	125	42.8	10	0.5	707	636	283	1 ¹⁾
TAJE108*006#NJ	E	1000	6.3	85	4	125	60	20	0.2	908	817	363	1 ¹⁾
TAJV108*006#NJ	V	1000	6.3	85	4	125	60	16	0.2	1118	1006	447	1 ¹⁾
10 Volt @ 85°C													
TAJR105*010#NJ	R	1	10	85	7	125	0.5	4	25	47	42	19	1
TAJS105*010#NJ	S	1	10	85	7	125	0.5	4	25	51	46	20	1
TAJA155*010#NJ	A	1.5	10	85	7	125	0.5	6	10	87	78	35	1
TAJR155*010#NJ	R	1.5	10	85	7	125	0.5	6	20	52	47	21	1
TAJS155*010#NJ	S	1.5	10	85	7	125	0.5	6	20	57	51	23	1
TAJA225*010#NJ	A	2.2	10	85	7	125	0.5	6	7	104	93	41	1
TAJR225*010#NJ	R	2.2	10	85	7	125	0.5	6	15	61	54	24	1
TAJS225*010#NJ	S	2.2	10	85	7	125	0.5	6	12	74	66	29	1
TAJA335*010#NJ	A	3.3	10	85	7	125	0.5	6	5.5	117	105	47	1
TAJK335*010#NJ	K	3.3	10	85	7	125	0.5	6	5.5	109	98	43	1
TAJR335*010#NJ	R	3.3	10	85	7	125	0.5	6	8	83	75	33	1
TAJS335*010#NJ	S	3.3	10	85	7	125	0.5	6	8	90	81	36	1



The Important Information/Disclaimer is incorporated in the catalog where these specifications came from or available online at www.avx.com/disclaimer/ by reference and should be reviewed in full before placing any order.

TAJ Series

Standard and Low Profile Tantalum Capacitors



RATINGS & PART NUMBER REFERENCE

AVX Part No.	Case Size	Capacitance (µF)	Rated Voltage (V)	Rated Temperature (°C)	Category Voltage (V)	Category Temperature (°C)	DCL Max. (µA)	DF Max. (%)	ESR Max. @ 100kHz (Ω)	100kHz RMS Current (mA)			MSL
										25°C	85°C	125°C	
TAJT335*010#NJ	T	3.3	10	85	7	125	0.5	6	6	115	104	46	1
TAJA475*010#NJ	A	4.7	10	85	7	125	0.5	6	5	122	110	49	1
TAJB475*010#NJ	B	4.7	10	85	7	125	0.5	6	4	146	131	58	1
TAJR475*010#NJ	R	4.7	10	85	7	125	0.5	6	9	78	70	31	1
TAJS475*010#NJ	S	4.7	10	85	7	125	0.5	6	5	114	103	46	1
TAJT475*010#NJ	T	4.7	10	85	7	125	0.5	6	5	126	114	51	1
TAJA685*010#NJ	A	6.8	10	85	7	125	0.7	6	4	137	123	55	1
TAJB685*010#NJ	B	6.8	10	85	7	125	0.7	6	3	168	151	67	1
TAJP685*010#NJ	P	6.8	10	85	7	125	0.6	6	5	110	99	44	1
TAJR685*010#NJ	R	6.8	10	85	7	125	0.7	6	5.2	103	93	41	1
TAJS685*010#NJ	S	6.8	10	85	7	125	0.7	6	4	127	115	51	1
TAJT685*010#NJ	T	6.8	10	85	7	125	0.7	6	4	141	127	57	1
TAJA106*010#NJ	A	10	10	85	7	125	1	6	3	158	142	63	1
TAJB106*010#NJ	B	10	10	85	7	125	1	6	2.1	201	181	80	1
TAJC106*010#NJ	C	10	10	85	7	125	1	6	2.5	210	189	84	1
TAJK106*010#NJ	K	10	10	85	7	125	1	6	2.2	172	155	69	1
TAJP106*010#NJ	P	10	10	85	7	125	1	8	6	100	90	40	1
TAJR106M010#NJ	R	10	10	85	7	125	1	20	6	96	86	38	1
TAJS106*010#NJ	S	10	10	85	7	125	1	8	3	147	132	59	1
TAJT106*010#NJ	T	10	10	85	7	125	1	6	3	163	147	65	1
TAJA156*010#NJ	A	15	10	85	7	125	1.5	6	3.2	153	138	61	1
TAJB156*010#NJ	B	15	10	85	7	125	1.5	6	2.8	174	157	70	1
TAJC156*010#NJ	C	15	10	85	7	125	1.5	6	2	235	211	94	1
TAJS156*010#NJ	S	15	10	85	7	125	1.5	6	2	180	162	72	1
TAJT156*010#NJ	T	15	10	85	7	125	1.5	8	2.8	169	152	68	1
TAJW156*010#NJ	W	15	10	85	7	125	1.5	6	0.7	359	323	143	1
TAJA226*010#NJ	A	22	10	85	7	125	2.2	8	3	158	142	63	1
TAJB226*010#NJ	B	22	10	85	7	125	2.2	6	2.4	188	169	75	1
TAJC226*010#NJ	C	22	10	85	7	125	2.2	6	1.8	247	222	99	1
TAJT226*010#NJ	T	22	10	85	7	125	2.2	8	2.2	191	172	76	1
TAJW226*010#NJ	W	22	10	85	7	125	2.2	6	0.6	387	349	155	1
TAJA336*010#NJ	A	33	10	85	7	125	3.3	8	1.7	210	189	84	1
TAJB336*010#NJ	B	33	10	85	7	125	3.3	6	1.8	217	196	87	1
TAJC336*010#NJ	C	33	10	85	7	125	3.3	6	1.6	262	236	105	1
TAJD336*010#NJ	D	33	10	85	7	125	3.3	6	1.1	369	332	148	1
TAJW336*010#NJ	W	33	10	85	7	125	3.3	6	1.6	237	213	95	1
TAJB476*010#NJ	B	47	10	85	7	125	4.7	8	1	292	262	117	1
TAJC476*010#NJ	C	47	10	85	7	125	4.7	6	1.2	303	272	121	1
TAJD476*010#NJ	D	47	10	85	7	125	4.7	6	0.4	612	551	245	1
TAJH476*006#NJ	H	47	10	85	7	125	4.7	8	1.0	283	255	113	1
TAJW476*010#NJ	W	47	10	85	7	125	4.7	6	1.4	254	228	101	1
TAJY476*010#NJ	Y	47	10	85	7	125	4.7	6	0.5	500	450	200	1 ¹⁾
TAJB686*010#NJ	B	68	10	85	7	125	6.8	8	1.4	246	222	99	1
TAJC686*010#NJ	C	68	10	85	7	125	6.8	6	1.3	291	262	116	1
TAJD686*010#NJ	D	68	10	85	7	125	6.8	6	0.9	408	367	163	1
TAJW686*010#NJ	W	68	10	85	7	125	6.8	6	1.2	274	246	110	1
TAJY686*010#NJ	Y	68	10	85	7	125	6.8	6	0.9	373	335	149	1 ¹⁾
TAJB107*010#NJ	B	100	10	85	7	125	10	8	1.4	246	222	99	1
TAJC107*010#NJ	C	100	10	85	7	125	10	8	1.2	303	272	121	1
TAJD107*010#NJ	D	100	10	85	7	125	10	6	0.9	408	367	163	1
TAJE107*010#NJ	E	100	10	85	7	125	10	6	0.9	428	385	171	1 ¹⁾
TAJW107*010#NJ	W	100	10	85	7	125	10	6	0.4	474	427	190	1
TAJX107*010#NJ	X	100	10	85	7	125	10	8	0.9	333	300	133	1 ¹⁾
TAJY107*010#NJ	Y	100	10	85	7	125	10	6	0.9	373	335	149	1 ¹⁾
TAJC157*010#NJ	C	150	10	85	7	125	15	8	0.9	350	315	140	1
TAJD157*010#NJ	D	150	10	85	7	125	15	8	0.9	408	367	163	1
TAJE157*010#NJ	E	150	10	85	7	125	15	8	0.9	428	385	171	1 ¹⁾
TAJF157*010#NJ	F	150	10	85	7	125	15	10	0.3	577	520	231	1
TAJX157M010#NJ	X	150	10	85	7	125	15	6	0.3	577	520	231	1 ¹⁾
TAJY157*010#NJ	Y	150	10	85	7	125	15	6	1.2	323	290	129	1 ¹⁾
TAJC227*010#NJ	C	220	10	85	7	125	22	16	0.5	469	422	188	1
TAJD227*010#NJ	D	220	10	85	7	125	22	8	0.5	548	493	219	1
TAJE227*010#NJ	E	220	10	85	7	125	22	8	0.5	574	517	230	1 ¹⁾
TAJY227*010#NJ	Y	220	10	85	7	125	22	10	0.5	500	450	200	1 ¹⁾
TAJD337*010#NJ	D	330	10	85	7	125	33	8	0.9	408	367	163	1
TAJE337*010#NJ	E	330	10	85	7	125	33	8	0.9	428	385	171	1 ¹⁾
TAJV337*010#NJ	V	330	10	85	7	125	33	10	0.9	527	474	211	1 ¹⁾
TAJE477*010#NJ	E	470	10	85	7	125	47	10	0.5	574	517	230	1 ¹⁾
TAJU477*010RNJ	U	470	10	85	7	125	47	12	0.5	574	517	230	1 ¹⁾
TAJV477*010#NJ	V	470	10	85	7	125	47	10	0.5	707	636	283	1 ¹⁾
TAJE687M010#NJV	E	680	10	85	7	125	68	18	0.4	642	578	257	3
TAJV687M010#NJV	V	680	10	85	7	125	68	18	0.4	791	712	316	3



TAJ Series

Standard and Low Profile Tantalum Capacitors



RATINGS & PART NUMBER REFERENCE

AVX Part No.	Case Size	Capacitance (µF)	Rated Voltage (V)	Rated Temperature (°C)	Category Voltage (V)	Category Temperature (°C)	DCL Max. (µA)	DF Max. (%)	ESR Max. @ 100kHz (Ω)	100kHz RMS Current (mA)			MSL
										25°C	85°C	125°C	
16 Volt @ 85°C													
TAJR684*016#NJ	R	0.68	16	85	10	125	0.5	4	25	47	42	19	1
TAJS684*016#NJ	S	0.68	16	85	10	125	0.5	4	25	51	46	20	1
TAJA105*016#NJ	A	1	16	85	10	125	0.5	4	11	83	74	33	1
TAJR105*016#NJ	R	1	16	85	10	125	0.5	4	20	52	47	21	1
TAJS105*016#NJ	S	1	16	85	10	125	0.5	4	15	66	59	26	1
TAJT105*016#NJ	T	1	16	85	10	125	0.5	4	5	126	114	51	1
TAJA155*016#NJ	A	1.5	16	85	10	125	0.5	6	8	97	87	39	1
TAJR155*016#NJ	R	1.5	16	85	10	125	0.5	6	10	74	67	30	1
TAJS155*016#NJ	S	1.5	16	85	10	125	0.5	6	12	74	66	29	1
TAJA225*016#NJ	A	2.2	16	85	10	125	0.5	6	6.5	107	97	43	1
TAJB225*016#NJ	B	2.2	16	85	10	125	0.5	6	2.3	192	173	77	1
TAJR225*016#NJ	R	2.2	16	85	10	125	0.5	6	6.5	92	83	37	1
TAJS225*016#NJ	S	2.2	16	85	10	125	0.5	6	6	104	94	42	1
TAJT225*016#NJ	T	2.2	16	85	10	125	0.5	6	6.5	111	100	44	1
TAJA335*016#NJ	A	3.3	16	85	10	125	0.5	6	5	122	110	49	1
TAJB335*016#NJ	B	3.3	16	85	10	125	0.5	6	4.5	137	124	55	1
TAJR335*016#NJ	R	3.3	16	85	10	125	0.5	8	5	105	94	42	1
TAJS335*016#NJ	S	3.3	16	85	10	125	0.5	6	5	114	103	46	1
TAJT335*016#NJ	T	3.3	16	85	10	125	0.5	6	5	126	114	51	1
TAJA475*016#NJ	A	4.7	16	85	10	125	0.8	6	4	137	123	55	1
TAJB475*016#NJ	B	4.7	16	85	10	125	0.8	6	3.5	156	140	62	1
TAJK475*016#NJ	K	4.7	16	85	10	125	0.8	6	3.1	145	130	58	1
TAJP475*016#NJ	P	4.7	16	85	10	125	0.8	8	5	110	99	44	1
TAJS475*016#NJ	S	4.7	16	85	10	125	0.8	8	4	127	115	51	1
TAJT475*016#NJ	T	4.7	16	85	10	125	0.8	6	3.1	161	145	64	1
TAJA685*016#NJ	A	6.8	16	85	10	125	1.1	6	3.5	146	132	59	1
TAJB685*016#NJ	B	6.8	16	85	10	125	1.1	6	2.5	184	166	74	1
TAJC685*016#NJ	C	6.8	16	85	10	125	1.1	6	2.5	210	189	84	1
TAJS685*016#NJ	S	6.8	16	85	10	125	1.1	8	2.4	165	148	66	1
TAJT685*016#NJ	T	6.8	16	85	10	125	1.1	6	3.5	151	136	60	1
TAJA106*016#NJ	A	10	16	85	10	125	1.6	6	3	158	142	63	1
TAJB106*016#NJ	B	10	16	85	10	125	1.6	6	2.8	174	157	70	1
TAJC106*016#NJ	C	10	16	85	10	125	1.6	6	2	235	211	94	1
TAJT106*016#NJ	T	10	16	85	10	125	1.6	8	2.2	191	172	76	1
TAJW106*016#NJ	W	10	16	85	10	125	1.6	6	2	212	191	85	1
TAJA156*016#NJ	A	15	16	85	10	125	2.4	6	2	194	174	77	1
TAJB156*016#NJ	B	15	16	85	10	125	2.4	6	2.5	184	166	74	1
TAJC156*016#NJ	C	15	16	85	10	125	2.4	6	1.8	247	222	99	1
TAJT156M016#NJ	T	15	16	85	10	125	2.4	6	2	200	180	80	1
TAJW156*016#NJ	W	15	16	85	10	125	2.4	6	0.7	359	323	143	1
TAJA226M016#NJ	A	22	16	85	10	125	3.5	10	2.3	181	163	72	1
TAJB226*016#NJ	B	22	16	85	10	125	3.5	6	2.3	192	173	77	1
TAJC226*016#NJ	C	22	16	85	10	125	3.5	6	1	332	298	133	1
TAJD226*016#NJ	D	22	16	85	10	125	3.5	6	1.1	369	332	148	1
TAJW226*016#NJ	W	22	16	85	10	125	3.5	6	1.6	237	213	95	1
TAJB336*016#NJ	B	33	16	85	10	125	5.3	8	2.1	201	181	80	1
TAJC336*016#NJ	C	33	16	85	10	125	5.3	6	1.5	271	244	108	1
TAJD336*016#NJ	D	33	16	85	10	125	5.3	6	0.9	408	367	163	1
TAJW336*016#NJ	W	33	16	85	10	125	5.3	6	1.5	245	220	98	1
TAJY336*016#NJ	Y	33	16	85	10	125	5.3	6	0.9	373	335	149	1 ¹⁾
TAJC476*016#NJ	C	47	16	85	10	125	7.5	6	0.5	469	422	188	1
TAJD476*016#NJ	D	47	16	85	10	125	7.5	6	0.9	408	367	163	1
TAJW476*016#NJ	W	47	16	85	10	125	7.5	6	0.4	474	427	190	1
TAJX476*016#NJ	X	47	16	85	10	125	7.5	6	0.75	365	329	146	1 ¹⁾
TAJY476*016#NJ	Y	47	16	85	10	125	7.5	6	0.7	423	380	169	1 ¹⁾
TAJC686*016#NJ	C	68	16	85	10	125	10.9	6	1.3	291	262	116	1
TAJD686*016#NJ	D	68	16	85	10	125	10.9	6	0.9	408	367	163	1
TAJF686*016#NJ	F	68	16	85	10	125	10.9	10	0.4	500	450	200	1
TAJX686*016#NJ	X	68	16	85	10	125	10.9	8	0.6	408	367	163	1 ¹⁾
TAJY686*016#NJ	Y	68	16	85	10	125	10.9	6	0.9	373	335	149	1 ¹⁾
TAJC107*016#NJ	C	100	16	85	10	125	16	8	1	332	298	133	1
TAJD107*016#NJ	D	100	16	85	10	125	16	6	0.6	500	450	200	1
TAJE107*016#NJ	E	100	16	85	10	125	16	6	0.9	428	385	171	1 ¹⁾
TAJF107M016#NJ	F	100	16	85	10	125	16	10	0.4	500	450	200	1
TAJY107*016#NJ	Y	100	16	85	10	125	16	8	0.9	373	335	149	1 ¹⁾
TAJD157*016#NJ	D	150	16	85	10	125	24	6	0.9	408	367	163	1
TAJE157*016#NJ	E	150	16	85	10	125	24	8	0.3	742	667	297	1 ¹⁾
TAJV157*016#NJ	V	150	16	85	10	125	24	8	0.5	707	636	283	1 ¹⁾
TAJY157M016#NJ	Y	150	16	85	10	125	24	15	0.3	645	581	258	1 ¹⁾
TAJD227M016#NJV	D	220	16	85	10	125	35.2	10	0.5	548	493	219	3
TAJE227*016#NJ	E	220	16	85	10	125	35.2	10	0.5	574	517	230	1 ¹⁾
TAJV227*016#NJ	V	220	16	85	10	125	35.2	8	0.9	527	474	211	1 ¹⁾
TAJE337M016#NJ	E	330	16	85	10	125	52.8	30	0.4	642	578	257	1 ¹⁾



The Important Information/Disclaimer is incorporated in the catalog where these specifications came from or available online at www.avx.com/disclaimer/ by reference and should be reviewed in full before placing any order.

TAJ Series

Standard and Low Profile Tantalum Capacitors



RATINGS & PART NUMBER REFERENCE

AVX Part No.	Case Size	Capacitance (µF)	Rated Voltage (V)	Rated Temperature (°C)	Category Voltage (V)	Category Temperature (°C)	DCL Max. (µA)	DF Max. (%)	ESR Max. @ 100kHz (Ω)	100kHz RMS Current (mA)			MSL
										25°C	85°C	125°C	
20 Volt @ 85°C													
TAJR104*020#NJ	R	0.1	20	85	13	125	0.5	4	25	47	42	19	1
TAJS104*020#NJ	S	0.1	20	85	13	125	0.5	4	25	51	46	20	1
TAJR154*020#NJ	R	0.15	20	85	13	125	0.5	4	25	47	42	19	1
TAJS154*020#NJ	S	0.15	20	85	13	125	0.5	4	25	51	46	20	1
TAJR224*020#NJ	R	0.22	20	85	13	125	0.5	4	25	47	42	19	1
TAJS224*020#NJ	S	0.22	20	85	13	125	0.5	4	25	51	46	20	1
TAJR334*020#NJ	R	0.33	20	85	13	125	0.5	4	25	47	42	19	1
TAJS334*020#NJ	S	0.33	20	85	13	125	0.5	4	25	51	46	20	1
TAJR474*020#NJ	R	0.47	20	85	13	125	0.5	4	25	47	42	19	1
TAJS474*020#NJ	S	0.47	20	85	13	125	0.5	4	25	51	46	20	1
TAJR684*020#NJ	R	0.68	20	85	13	125	0.5	4	20	52	47	21	1
TAJS684*020#NJ	S	0.68	20	85	13	125	0.5	4	25	51	46	20	1
TAJT684*020#NJ	T	0.68	20	85	13	125	0.5	4	15	73	66	29	1
TAJA105*020#NJ	A	1	20	85	13	125	0.5	4	9	91	82	37	1
TAJR105*020#NJ	R	1	20	85	13	125	0.5	4	20	52	47	21	1
TAJS105*020#NJ	S	1	20	85	13	125	0.5	4	12	74	66	29	1
TAJT105*020#NJ	T	1	20	85	13	125	0.5	4	9	94	85	38	1
TAJA155*020#NJ	A	1.5	20	85	13	125	0.5	6	6.5	107	97	43	1
TAJP155*020#NJ	P	1.5	20	85	13	125	0.5	6	9.6	79	71	32	1
TAJR155*020#NJ	R	1.5	20	85	13	125	0.5	6	9.6	76	68	30	1
TAJS155*020#NJ	S	1.5	20	85	13	125	0.5	6	5.4	110	99	44	1
TAJT155*020#NJ	T	1.5	20	85	13	125	0.5	6	6.5	111	100	44	1
TAJA225*020#NJ	A	2.2	20	85	13	125	0.5	6	5.3	119	107	48	1
TAJB225*020#NJ	B	2.2	20	85	13	125	0.5	6	3.5	156	140	62	1
TAJP225*020#NJ	P	2.2	20	85	13	125	0.5	6	8.3	85	77	34	1
TAJR225*020#NJ	R	2.2	20	85	13	125	0.5	6	6	96	86	38	1
TAJS225*020#NJ	S	2.2	20	85	13	125	0.5	6	4.5	120	108	48	1
TAJT225*020#NJ	T	2.2	20	85	13	125	0.5	6	6	115	104	46	1
TAJA335*020#NJ	A	3.3	20	85	13	125	0.7	6	4.5	129	116	52	1
TAJB335*020#NJ	B	3.3	20	85	13	125	0.7	6	3	168	151	67	1
TAJT335*020#NJ	T	3.3	20	85	13	125	0.7	6	3	163	147	65	1
TAJA475*020#NJ	A	4.7	20	85	13	125	0.9	6	4	137	123	55	1
TAJB475*020#NJ	B	4.7	20	85	13	125	0.9	6	3	168	151	67	1
TAJC475*020#NJ	C	4.7	20	85	13	125	0.9	6	2.8	198	178	79	1
TAJT475*020#NJ	T	4.7	20	85	13	125	0.9	6	3.1	161	145	64	1
TAJA685*020#NJ	A	6.8	20	85	13	125	1.4	6	2.4	177	159	71	1
TAJB685*020#NJ	B	6.8	20	85	13	125	1.4	6	2.5	184	166	74	1
TAJC685*020#NJ	C	6.8	20	85	13	125	1.4	6	2	235	211	94	1
TAJT685*020#NJ	T	6.8	20	85	13	125	1.4	6	2.6	175	158	70	1
TAJB106*020#NJ	B	10	20	85	13	125	2	6	2.1	201	181	80	1
TAJC106*020#NJ	C	10	20	85	13	125	2	6	1.2	303	272	121	1
TAJW106*020#NJ	W	10	20	85	13	125	2	6	1.9	218	196	87	1
TAJB156*020#NJ	B	15	20	85	13	125	3	6	2	206	186	82	1
TAJC156*020#NJ	C	15	20	85	13	125	3	6	1.7	254	229	102	1
TAJD156*020#NJ	D	15	20	85	13	125	3	6	1.1	369	332	148	1
TAJW156*020#NJ	W	15	20	85	13	125	3	6	1.7	230	207	92	1
TAJB226*020#NJ	B	22	20	85	13	125	4.4	6	1.8	217	196	87	1
TAJC226*020#NJ	C	22	20	85	13	125	4.4	6	1.6	262	236	105	1
TAJD226*020#NJ	D	22	20	85	13	125	4.4	6	0.9	408	367	163	1
TAJW226*020#NJ	W	22	20	85	13	125	4.4	6	1.6	237	213	95	1
TAJY226*020#NJ	Y	22	20	85	13	125	4.4	6	0.9	373	335	149	1 ¹⁾
TAJC336*020#NJ	C	33	20	85	13	125	6.6	6	1.5	271	244	108	1
TAJD336*020#NJ	D	33	20	85	13	125	6.6	6	0.9	408	367	163	1
TAJX336*020#NJ	X	33	20	85	13	125	6.6	6	0.5	447	402	179	1 ¹⁾
TAJY336*020#NJ	Y	33	20	85	13	125	6.6	6	0.6	456	411	183	1 ¹⁾
TAJC476*020#NJ	C	47	20	85	13	125	9.4	6	0.5	469	422	188	1
TAJD476*020#NJ	D	47	20	85	13	125	9.4	6	0.9	408	367	163	1
TAJE476*020#NJ	E	47	20	85	13	125	9.4	6	0.9	428	385	171	1 ¹⁾
TAJX476*020#NJ	X	47	20	85	13	125	9.4	6	0.4	500	450	200	1 ¹⁾
TAJY476*020#NJ	Y	47	20	85	13	125	9.4	6	0.9	373	335	149	1 ¹⁾
TAJC686*020#NJ	C	68	20	85	13	125	13.6	8	0.5	469	422	188	1
TAJD686*020#NJ	D	68	20	85	13	125	13.6	6	0.4	612	551	245	1
TAJE686*020#NJ	E	68	20	85	13	125	13.6	6	0.9	428	385	171	1 ¹⁾
TAJY686*020#NJ	Y	68	20	85	13	125	13.6	6	0.9	373	335	149	1 ¹⁾
TAJD107*020#NJ	D	100	20	85	13	125	20	6	0.5	548	493	219	1
TAJE107*020#NJ	E	100	20	85	13	125	20	6	0.4	642	578	257	1 ¹⁾
TAJV107*020#NJ	V	100	20	85	13	125	20	8	0.9	527	474	211	1 ¹⁾
TAJE157*020#NJ	E	150	20	85	13	125	30	8	0.3	742	667	297	1 ¹⁾
TAJV157*020#NJ	V	150	20	85	13	125	30	8	0.3	913	822	365	1 ¹⁾

TAJ Series

Standard and Low Profile Tantalum Capacitors



RATINGS & PART NUMBER REFERENCE

AVX Part No.	Case Size	Capacitance (µF)	Rated Voltage (V)	Rated Temperature (°C)	Category Voltage (V)	Category Temperature (°C)	DCL Max. (µA)	DF Max. (%)	ESR Max. @ 100kHz (Ω)	100kHz RMS Current (mA)			MSL
										25°C	85°C	125°C	
25 Volt @ 85°C													
TAJR154*025#NJ	R	0.15	25	85	17	125	0.5	4	24	48	43	19	1
TAJR224*025#NJ	R	0.22	25	85	17	125	0.5	4	21	51	46	20	1
TAJR334*025#NJ	R	0.33	25	85	17	125	0.5	4	17	57	51	23	1
TAJA474*025#NJ	A	0.47	25	85	17	125	0.5	4	14	73	66	29	1
TAJR474*025#NJ	R	0.47	25	85	17	125	0.5	4	15	61	54	24	1
TAJS474*025#NJ	S	0.47	25	85	17	125	0.5	4	9	85	76	34	1
TAJA684*025#NJ	A	0.68	25	85	17	125	0.5	4	10	87	78	35	1
TAJR684*025#NJ	R	0.68	25	85	17	125	0.5	4	13	65	59	26	1
TAJS684*025#NJ	S	0.68	25	85	17	125	0.5	4	8	90	81	36	1
TAJA105*025#NJ	A	1	25	85	17	125	0.5	4	8	97	87	39	1
TAJP105*025#NJ	P	1	25	85	17	125	0.5	4	11	74	66	30	1
TAJR105*025#NJ	R	1	25	85	17	125	0.5	4	8	83	75	33	1
TAJS105*025#NJ	S	1	25	85	17	125	0.5	4	8	90	81	36	1
TAJA155*025#NJ	A	1.5	25	85	17	125	0.5	6	7.5	100	90	40	1
TAJB155*025#NJ	B	1.5	25	85	17	125	0.5	6	5	130	117	52	1
TAJP155*025#NJ	P	1.5	25	85	17	125	0.5	6	9.6	79	71	32	1
TAJS155*025#NJ	S	1.5	25	85	17	125	0.5	6	5.4	110	99	44	1
TAJT155*025#NJ	T	1.5	25	85	17	125	0.5	6	5	126	114	51	1
TAJA225*025#NJ	A	2.2	25	85	17	125	0.6	6	7	104	93	41	1
TAJB225*025#NJ	B	2.2	25	85	17	125	0.6	6	4.5	137	124	55	1
TAJT225*025#NJ	T	2.2	25	85	17	125	0.6	6	4.5	133	120	53	1
TAJA335*025#NJ	A	3.3	25	85	17	125	0.8	6	3.7	142	128	57	1
TAJB335*025#NJ	B	3.3	25	85	17	125	0.8	6	3.5	156	140	62	1
TAJC335*025#NJ	C	3.3	25	85	17	125	0.8	6	2.8	198	178	79	1
TAJT335*025#NJ	T	3.3	25	85	17	125	0.8	6	3.5	151	136	60	1
TAJW335*025#NJ	W	3.3	25	85	17	125	0.8	6	1.6	237	213	95	1
TAJA475*025#NJ	A	4.7	25	85	17	125	1.2	6	3.1	156	140	62	1
TAJB475*025#NJ	B	4.7	25	85	17	125	1.2	6	1.5	238	214	95	1
TAJC475*025#NJ	C	4.7	25	85	17	125	1.2	6	2.4	214	193	86	1
TAJT475*025#NJ	T	4.7	25	85	17	125	1.2	6	3.1	161	145	64	1
TAJW475*025#NJ	W	4.7	25	85	17	125	1.2	6	1.2	274	246	110	1
TAJB685*025#NJ	B	6.8	25	85	17	125	1.7	6	2.8	174	157	70	1
TAJC685*025#NJ	C	6.8	25	85	17	125	1.7	6	2	235	211	94	1
TAJW685*025#NJ	W	6.8	25	85	17	125	1.7	6	2	212	191	85	1
TAJB106*025#NJ	B	10	25	85	17	125	2.5	6	2.5	184	166	74	1
TAJC106*025#NJ	C	10	25	85	17	125	2.5	6	1.8	247	222	99	1
TAJD106*025#NJ	D	10	25	85	17	125	2.5	6	1.2	354	318	141	1
TAJW106*025#NJ	W	10	25	85	17	125	2.5	6	1.8	224	201	89	1
TAJC156*025#NJ	C	15	25	85	17	125	3.8	6	1.6	262	236	105	1
TAJD156*025#NJ	D	15	25	85	17	125	3.8	6	1	387	349	155	1
TAJY156*025#NJ	Y	15	25	85	17	125	3.8	6	1	354	318	141	1 ¹⁾
TAJC226*025#NJ	C	22	25	85	17	125	5.5	6	1.4	280	252	112	1
TAJD226*025#NJ	D	22	25	85	17	125	5.5	6	0.9	408	367	163	1
TAJF226*025#NJ	F	22	25	85	17	125	5.5	6	1	316	285	126	1
TAJY226*025#NJ	Y	22	25	85	17	125	5.5	6	0.8	395	356	158	1 ¹⁾
TAJC336*025#NJ	C	33	25	85	17	125	8.3	6	0.9	350	315	140	1
TAJD336*025#NJ	D	33	25	85	17	125	8.3	6	0.9	408	367	163	1
TAJE336*025#NJ	E	33	25	85	17	125	8.3	6	0.9	428	385	171	1 ¹⁾
TAJF336*025#NJ	F	33	25	85	17	125	8.3	6	0.9	333	300	133	1
TAJY336*025#NJ	Y	33	25	85	17	125	8.3	6	0.5	500	450	200	1 ¹⁾
TAJD476*025#NJ	D	47	25	85	17	125	11.8	6	0.9	408	367	163	1
TAJE476*025#NJ	E	47	25	85	17	125	11.8	6	0.9	428	385	171	1 ¹⁾
TAJY476*025#NJ	Y	47	25	85	17	125	11.8	6	0.9	373	335	149	1 ¹⁾
TAJD686*025#NJ	D	68	25	85	17	125	17	6	0.9	408	367	163	1
TAJE686*025#NJ	E	68	25	85	17	125	17	6	0.9	428	385	171	1 ¹⁾
TAJV686*025#NJ	V	68	25	85	17	125	17	6	0.9	527	474	211	1 ¹⁾
TAJE107*025#NJ	E	100	25	85	17	125	25	10	0.3	742	667	297	1 ¹⁾
TAJV107*025#NJ	V	100	25	85	17	125	25	8	0.4	791	712	316	1 ¹⁾
TAJV157M025#NJ	V	150	25	85	17	125	37.5	10	0.4	791	712	316	1 ¹⁾
35 Volt @ 85°C													
TAJA104*035#NJ	A	0.1	35	85	23	125	0.5	4	24	56	50	22	1
TAJR104*035#NJ	R	0.1	35	85	23	125	0.5	4	29	44	39	17	1
TAJS104*035#NJ	S	0.1	35	85	23	125	0.5	4	24	52	47	21	1
TAJA154*035#NJ	A	0.15	35	85	23	125	0.5	4	21	60	54	24	1
TAJR154*035#NJ	R	0.15	35	85	23	125	0.5	4	24	48	43	19	1
TAJS154*035#NJ	S	0.15	35	85	23	125	0.5	4	21	56	50	22	1
TAJA224*035#NJ	A	0.22	35	85	23	125	0.5	4	18	65	58	26	1
TAJR224*035#NJ	R	0.22	35	85	23	125	0.5	4	21	51	46	20	1
TAJS224*035#NJ	S	0.22	35	85	23	125	0.5	4	18	60	54	24	1
TAJA334*035#NJ	A	0.33	35	85	23	125	0.5	4	15	71	64	28	1
TAJR334*035#NJ	R	0.33	35	85	23	125	0.5	4	17	57	51	23	1



The Important Information/Disclaimer is incorporated in the catalog where these specifications came from or available online at www.avx.com/disclaimer/ by reference and should be reviewed in full before placing any order.

TAJ Series

Standard and Low Profile Tantalum Capacitors



RATINGS & PART NUMBER REFERENCE

AVX Part No.	Case Size	Capacitance (µF)	Rated Voltage (V)	Rated Temperature (°C)	Category Voltage (V)	Category Temperature (°C)	DCL Max. (µA)	DF Max. (%)	ESR Max. @ 100kHz (Ω)	100kHz RMS Current (mA)			MSL
										25°C	85°C	125°C	
TAJS334*035#NJ	S	0.33	35	85	23	125	0.5	4	15	66	59	26	1
TAJA474*035#NJ	A	0.47	35	85	23	125	0.5	4	12	79	71	32	1
TAJB474*035#NJ	B	0.47	35	85	23	125	0.5	4	10	92	83	37	1
TAJR474*035#NJ	R	0.47	35	85	23	125	0.5	4	15	61	54	24	1
TAJS474*035#NJ	S	0.47	35	85	23	125	0.5	4	12	74	66	29	1
TAJT474*035#NJ	T	0.47	35	85	23	125	0.5	4	10	89	80	36	1
TAJA684*035#NJ	A	0.68	35	85	23	125	0.5	4	8	97	87	39	1
TAJB684*035#NJ	B	0.68	35	85	23	125	0.5	4	8	103	93	41	1
TAJP684*035#NJ	P	0.68	35	85	23	125	0.5	4	13	68	61	27	1
TAJS684*035#NJ	S	0.68	35	85	23	125	0.5	4	8	90	81	36	1
TAJT684*035#NJ	T	0.68	35	85	23	125	0.5	4	8	100	90	40	1
TAJA105*035#NJ	A	1	35	85	23	125	0.5	4	7.5	100	90	40	1
TAJB105*035#NJ	B	1	35	85	23	125	0.5	4	6.5	114	103	46	1
TAJP105*035#NJ	P	1	35	85	23	125	0.5	4	11	74	66	30	1
TAJS105*035#NJ	S	1	35	85	23	125	0.5	4	7.5	93	84	37	1
TAJT105*035#NJ	T	1	35	85	23	125	0.5	4	6.5	111	100	44	1
TAJA155*035#NJ	A	1.5	35	85	23	125	0.5	6	7.5	100	90	40	1
TAJB155*035#NJ	B	1.5	35	85	23	125	0.5	6	5.2	128	115	51	1
TAJC155*035#NJ	C	1.5	35	85	23	125	0.5	6	4.5	156	141	63	1
TAJT155*035#NJ	T	1.5	35	85	23	125	0.5	6	5.2	124	112	50	1
TAJA225*035#NJ	A	2.2	35	85	23	125	0.8	6	4.5	129	116	52	1
TAJB225*035#NJ	B	2.2	35	85	23	125	0.8	6	4.2	142	128	57	1
TAJC225*035#NJ	C	2.2	35	85	23	125	0.8	6	3.5	177	160	71	1
TAJT225*035#NJ	T	2.2	35	85	23	125	0.8	6	4.2	138	124	55	1
TAJB335*035#NJ	B	3.3	35	85	23	125	1.2	6	3.5	156	140	62	1
TAJC335*035#NJ	C	3.3	35	85	23	125	1.2	6	2.5	210	189	84	1
TAJW335*035#NJ	W	3.3	35	85	23	125	1.2	6	1.6	237	213	95	1
TAJB475*035#NJ	B	4.7	35	85	23	125	1.6	6	3.1	166	149	66	1
TAJC475*035#NJ	C	4.7	35	85	23	125	1.6	6	2.2	224	201	89	1
TAJD475*035#NJ	D	4.7	35	85	23	125	1.6	6	1.5	316	285	126	1
TAJW475*035#NJ	W	4.7	35	85	23	125	1.6	6	2.2	202	182	81	1
TAJC685*035#NJ	C	6.8	35	85	23	125	2.4	6	1.8	247	222	99	1
TAJD685*035#NJ	D	6.8	35	85	23	125	2.4	6	1.3	340	306	136	1
TAJY685*035#NJ	Y	6.8	35	85	23	125	2.3	6	0.9	373	335	149	1 ¹⁾
TAJC106*035#NJ	C	10	35	85	23	125	3.5	6	1.6	262	236	105	1
TAJD106*035#NJ	D	10	35	85	23	125	3.5	6	1	387	349	155	1
TAJE106*035#NJ	E	10	35	85	23	125	3.5	6	0.9	428	385	171	1 ¹⁾
TAJX106*035#NJ	X	10	35	85	23	125	3.5	6	0.7	378	340	151	1 ¹⁾
TAJY106*035#NJ	Y	10	35	85	23	125	3.5	6	1	354	318	141	1 ¹⁾
TAJC156*035#NJ	C	15	35	85	23	125	5.3	6	1.4	280	252	112	1
TAJD156*035#NJ	D	15	35	85	23	125	5.3	6	0.9	408	367	163	1
TAJY156*035#NJ	Y	15	35	85	23	125	5.3	6	0.6	456	411	183	1 ¹⁾
TAJD226*035#NJ	D	22	35	85	23	125	7.7	6	0.9	408	367	163	1
TAJE226*035#NJ	E	22	35	85	23	125	7.7	6	0.5	574	517	230	1 ¹⁾
TAJY226*035#NJ	Y	22	35	85	23	125	7.7	6	0.5	500	450	200	1 ¹⁾
TAJD336*035#NJ	D	33	35	85	23	125	11.6	6	0.9	408	367	163	1
TAJE336*035#NJ	E	33	35	85	23	125	11.6	6	0.9	428	385	171	1 ¹⁾
TAJV336*035#NJ	V	33	35	85	23	125	11.6	6	0.5	707	636	283	1 ¹⁾
TAJD476*035#NJ	D	47	35	85	23	125	16.5	6	0.9	408	367	163	3
TAJE476*035#NJ	E	47	35	85	23	125	16.5	6	0.9	428	385	171	1 ¹⁾
TAJV476*035#NJ	V	47	35	85	23	125	16.5	6	0.4	791	712	316	1 ¹⁾
TAJV686*035#NJ	V	68	35	85	23	125	23.8	6	0.5	707	636	283	1 ¹⁾
50 Volt @ 85°C													
TAJA104*050#NJ	A	0.1	50	85	33	125	0.5	4	22	58	53	23	1
TAJS104*050#NJ	S	0.1	50	85	33	125	0.5	4	19	58	53	23	1
TAJA154*050#NJ	A	0.15	50	85	33	125	0.5	4	15	71	64	28	1
TAJB154*050#NJ	B	0.15	50	85	33	125	0.5	4	17	71	64	28	1
TAJS154*050#NJ	S	0.15	50	85	33	125	0.5	4	16	64	57	25	1
TAJA224*050#NJ	A	0.22	50	85	33	125	0.5	4	18	65	58	26	1
TAJB224*050#NJ	B	0.22	50	85	33	125	0.5	4	14	78	70	31	1
TAJP224*050#NJ	P	0.22	50	85	33	125	0.5	4	17	59	53	24	1
TAJR224*050#NJ	R	0.22	50	85	33	125	0.5	4	17	57	51	23	1
TAJS224*050#NJ	S	0.22	50	85	33	125	0.5	4	13	71	64	28	1
TAJA334*050#NJ	A	0.33	50	85	33	125	0.5	4	17	66	60	27	1
TAJB334*050#NJ	B	0.33	50	85	33	125	0.5	4	12	84	76	34	1
TAJP334*050#NJ	P	0.33	50	85	33	125	0.5	4	17	59	53	24	1
TAJR334M050#NJ	R	0.33	50	85	33	125	0.5	4	17	57	51	23	1
TAJS334*050#NJ	S	0.33	50	85	33	125	0.5	4	11	77	69	31	1
TAJT334*050#NJ	T	0.33	50	85	33	125	0.5	4	11	85	77	34	1
TAJA474*050#NJ	A	0.47	50	85	33	125	0.5	4	9.5	89	80	36	1
TAJB474*050#NJ	B	0.47	50	85	33	125	0.5	4	9.5	95	85	38	1
TAJC474*050#NJ	C	0.47	50	85	33	125	0.5	4	8	117	106	47	1



TAJ Series

Standard and Low Profile Tantalum Capacitors



RATINGS & PART NUMBER REFERENCE

AVX Part No.	Case Size	Capacitance (µF)	Rated Voltage (V)	Rated Temperature (°C)	Category Voltage (V)	Category Temperature (°C)	DCL Max. (µA)	DF Max. (%)	ESR Max. @ 100kHz (Ω)	100kHz RMS Current (mA)			MSL
										25°C	85°C	125°C	
TAJS474*050#NJ	S	0.47	50	85	33	125	0.5	4	9.5	83	74	33	1
TAJT474*050#NJ	T	0.47	50	85	33	125	0.5	4	9.5	92	83	37	1
TAJA684*050#NJ	A	0.68	50	85	33	125	0.5	4	7.9	97	88	39	1
TAJB684*050#NJ	B	0.68	50	85	33	125	0.5	4	8	103	93	41	1
TAJC684*050#NJ	C	0.68	50	85	33	125	0.5	4	7	125	113	50	1
TAJA105*050#NJ	A	1	50	85	33	125	0.5	4	6.6	107	96	43	1
TAJB105*050#NJ	B	1	50	85	33	125	0.5	6	7	110	99	44	1
TAJC105*050#NJ	C	1	50	85	33	125	0.5	4	5.5	141	127	57	1
TAJW105*050#NJ	W	1	50	85	33	125	0.5	6	4.4	143	129	57	1
TAJB155*050#NJ	B	1.5	50	85	33	125	0.8	8	5.4	125	113	50	1
TAJC155*050#NJ	C	1.5	50	85	33	125	0.8	6	4.5	156	141	63	1
TAJD155*050#NJ	D	1.5	50	85	33	125	0.8	6	4	194	174	77	1
TAJW155*050#NJ	W	1.5	50	85	33	125	0.8	6	3.1	170	153	68	1
TAJB225*050#NJ	B	2.2	50	85	33	125	1.1	8	4.5	137	124	55	1
TAJC225*050#NJ	C	2.2	50	85	33	125	1.1	8	2.5	210	189	84	1
TAJD225*050#NJ	D	2.2	50	85	33	125	1.1	6	2.5	245	220	98	1
TAJW225*050#NJ	W	2.2	50	85	33	125	1.1	8	2.5	190	171	76	1
TAJC335*050#NJ	C	3.3	50	85	33	125	1.6	6	2.5	210	189	84	1
TAJD335*050#NJ	D	3.3	50	85	33	125	1.7	6	2	274	246	110	1
TAJY335*050#NJ	Y	3.3	50	85	33	125	1.7	4	1.5	289	260	115	1 ¹⁾
TAJC475*050#NJ	C	4.7	50	85	33	125	2.4	6	1.4	280	252	112	1
TAJD475*050#NJ	D	4.7	50	85	33	125	2.4	6	1.4	327	295	131	1
TAJX475*050#NJ	X	4.7	50	85	33	125	2.4	6	1.0	316	285	126	3
TAJY475*050#NJ	Y	4.7	50	85	33	125	2.4	6	1.2	323	290	129	1 ¹⁾
TAJC685*050#NJ	C	6.8	50	85	33	125	3.4	6	1	332	298	133	1
TAJD685*050#NJ	D	6.8	50	85	33	125	3.4	6	1	387	349	155	1
TAJY685*050#NJ	Y	6.8	50	85	33	125	3.4	6	0.9	373	335	149	1 ¹⁾
TAJD106*050#NJ	D	10	50	85	33	125	5	6	0.8	433	390	173	1
TAJE106*050#NJ	E	10	50	85	33	125	5	6	0.8	454	409	182	1 ¹⁾
TAJV106*050#NJ	V	10	50	85	33	125	5	6	0.65	620	558	248	1 ¹⁾
TAJD156*050#NJ	D	15	50	85	33	125	7.5	6	0.6	500	450	200	1
TAJE156*050#NJ	E	15	50	85	33	125	7.5	6	0.6	524	472	210	1 ¹⁾
TAJV156*050#NJ	V	15	50	85	33	125	7.5	6	0.6	645	581	258	1 ¹⁾
TAJV226*050#NJ	V	22	50	85	33	125	11	8	0.6	645	581	258	1 ¹⁾

1¹⁾ – Dry pack option (see How to order) is recommended for reduction of stress during soldering. Dry pack parts should be treated as MSL 3.

Moisture Sensitivity Level (MSL) is defined according to J-STD-020.

All technical data relates to an ambient temperature of +25°C. Capacitance and DF are measured at 120Hz, 0.5V RMS with a maximum DC bias of 2.2 volts. DCL is measured at rated voltage after 5 minutes.

For typical weight and composition see page 274.

NOTE: AVX reserves the right to supply higher voltage ratings or tighter tolerance part in the same case size, to the same reliability standards.

*Initial Limit

QUALIFICATION TABLE

TEST	TAJ series (Temperature range -55°C to +125°C)									
	Condition			Characteristics						
Endurance	Apply rated voltage (Ur) at 85°C and / or category voltage (Uc) at 125°C for 2000 hours through a circuit impedance of $\leq 0.1\Omega/V$. Stabilize at room temperature for 1-2 hours before measuring.			Visual examination	no visible damage					
				DCL	1.25 x initial limit					
				$\Delta C/C$	within $\pm 10\%$ of initial value					
				DF	initial limit					
Humidity	Store at 65°C and 95% relative humidity for 500 hours, with no applied voltage. Stabilize at room temperature and humidity for 1-2 hours before measuring.			Visual examination	no visible damage					
				DCL	1.5 x initial limit					
				$\Delta C/C$	within $\pm 10\%$ of initial value					
				DF	1.2 x initial limit					
Temperature Stability	Step	Temperature°C	Duration(min)		+20°C	-55°C	+20°C	+85°C	+125°C	+20°C
	1	+20	15							
	2	-55	15	DCL	IL*	n/a	IL*	10 x IL*	12.5 x IL*	IL*
	3	+20	15	$\Delta C/C$	n/a	+0/-10%	$\pm 5\%$	+10/-0%	+12/-0%	$\pm 5\%$
	4	+85	15	DF	IL*	1.5 x IL*	IL*	1.5 x IL*	2 x IL*	IL*
	5	+125	15							
6	+20	15								
Surge Voltage	Apply 1.3x category voltage (Uc) at 125°C for 1000 cycles of duration 6 min (30 sec charge, 5 min 30 sec discharge) through a charge / discharge resistance of 1000 Ω			Visual examination	no visible damage					
				DCL	initial limit					
				$\Delta C/C$	within $\pm 5\%$ of initial value					
				DF	initial limit					
Mechanical Shock	MIL-STD-202, Method 213, Condition C			Visual examination	no visible damage					
				DCL	initial limit					
				$\Delta C/C$	within $\pm 5\%$ of initial value					
				DF	initial limit					
				ESR	initial limit					
Vibration	MIL-STD-202, Method 204, Condition D			Visual examination	no visible damage					
				DCL	initial limit					
				$\Delta C/C$	within $\pm 5\%$ of initial value					
				DF	initial limit					
				ESR	initial limit					

TAJ Series

Standard and Low Profile Tantalum Capacitors

AVX SOLID ELECTROLYTIC CAPACITOR ROADMAP

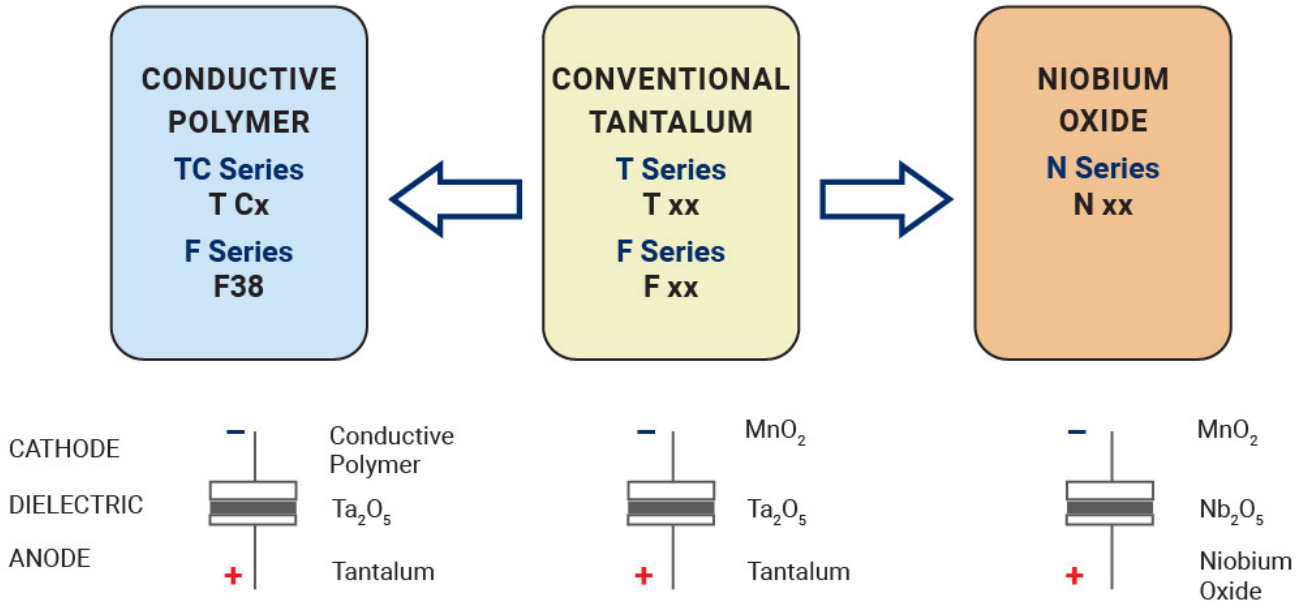

FIVE CAPACITOR CONSTRUCTION STYLES

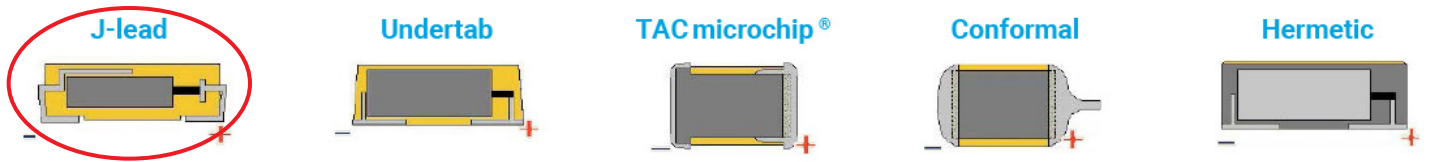

SERIES LINE UP: CONVENTIONAL SMD MnO₂

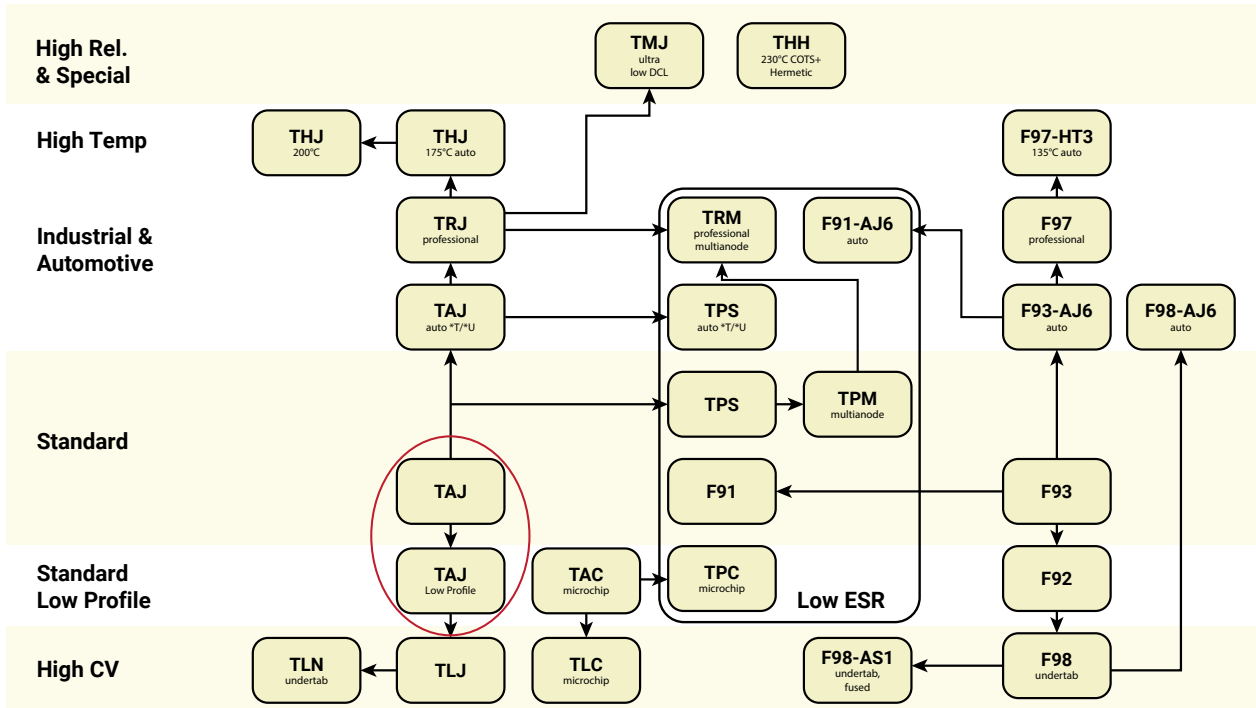

TAJ Automotive Range

Standard Tantalum - Automotive Product Range

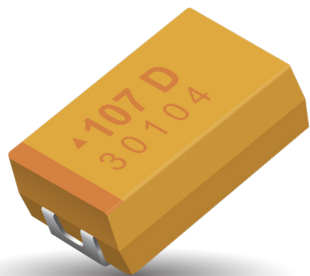

FEATURES

- General Purpose SMT Chip Tantalum Series
- 100% Surge Current Tested
- 7 Case Sizes Available
- CV Range: 0.22-680µF / 6.3-50V



APPLICATIONS

- Audio Systems
- GPS
- Seat Controls
- Dashboard

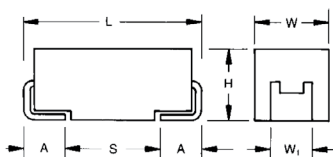

CASE DIMENSIONS:

millimeters (inches)

Code	EIA Code	EIA Metric	L±0.20 (0.008)	W+0.20 (0.008) -0.10 (0.004)	H+0.20 (0.008) -0.10 (0.004)	W ₁ ±0.20 (0.008)	A+0.30 (0.012) -0.20 (0.008)	S Min.
A	1206	3216-18	3.20 (0.126)	1.60 (0.063)	1.60 (0.063)	1.20 (0.047)	0.80 (0.031)	1.10 (0.043)
B	1210	3528-21	3.50 (0.138)	2.80 (0.110)	1.90 (0.075)	2.20 (0.087)	0.80 (0.031)	1.40 (0.055)
C	2312	6032-28	6.00 (0.236)	3.20 (0.126)	2.60 (0.102)	2.20 (0.087)	1.30 (0.051)	2.90 (0.114)
D	2917	7343-31	7.30 (0.287)	4.30 (0.169)	2.90 (0.114)	2.40 (0.094)	1.30 (0.051)	4.40 (0.173)
E	2917	7343-43	7.30 (0.287)	4.30 (0.169)	4.10 (0.162)	2.40 (0.094)	1.30 (0.051)	4.40 (0.173)
P	0805	2012-15	2.05 (0.081)	1.35 (0.053)	1.50 (0.059) max.	1.00±0.10 (0.039±0.004)	0.50 (0.020)	0.85 (0.033)
Y	2917	7343-20	7.30 (0.287)	4.30 (0.169)	2.00 (0.079)	2.40 (0.094)	1.30 (0.051)	4.40 (0.173)

W₁ dimension applies to the termination width for A dimensional area only.

MARKING

A, B, C, D, E, Y CASE

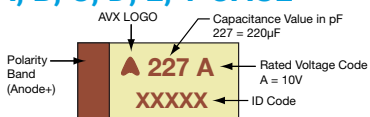

P CASE

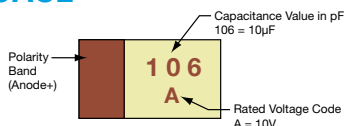

HOW TO ORDER

TAJ	C	106	M	035	T	NJ	V
Type	Case Size See table above	Capacitance Code pF code: 1st two digits represent significant figures, 3rd digit represents multiplier (number of zeros to follow)	Tolerance K = ±10% M = ±20%	Rated DC Voltage 006 = 6.3Vdc 010 = 10Vdc 016 = 16Vdc 020 = 20Vdc	Packaging T = Automotive Lead Free 7" Reel U = Automotive Lead Free 13" Reel	Specification Suffix NJ = Std Suffix	Dry Pack Option (D,E,Y case sizes mandatory)

TECHNICAL SPECIFICATIONS

Technical Data:	All technical data relate to an ambient temperature of +25°C								
Capacitance Range:	0.22 µF to 680 µF								
Capacitance Tolerance:	±10%; ±20%								
Rated Voltage (V _R)	≤ +85°C:	6.3	10	16	20	25	35	50	
Category Voltage (V _C)	≤ +125°C:	4	7	10	13	17	23	33	
Surge Voltage (V _S)	≤ +85°C:	8	13	20	26	32	46	65	
Surge Voltage (V _S)	≤ +125°C:	5	8	13	16	20	28	40	
Temperature Range:	-55°C to +125°C								
Environmental Classification:	55/125/56 (IEC 68-2)								
Reliability:	1% per 1000 hours at 85°C, V _R with 0.1Ω/V series impedance, 60% confidence level								
Termination Finished:	Sn Plating (standard), Gold and SnPb Plating upon request								
	Meets requirements of AEC-Q200								

TAJ Automotive Range

Standard Tantalum - Automotive Product Range



TAJ AUTOMOTIVE RANGE CAPACITANCE AND RATED VOLTAGE RANGE (LETTER DENOTES CASE SIZE)

Capacitance		Rated voltage DC (V_R to 85°C)						
μF	Code	6.3V (J)	10V (A)	16V (C)	20V (D)	25V (E)	35V (V)	50V (T)
0.10	104							
0.15	154							
0.22	224							A
0.33	334						A	A
0.47	474					A	A	A/B
0.68	684					A	A	B
1.0	105			A	A	A	A/B	B/C
1.5	155				A	A/B	A/B	C
2.2	225		A	A	A/B	A/B	B/C	C/D
3.3	335	A		A/B	A/B	A/B	B/C	C/D
4.7	475		A/B	A/B	A/B	B/C	B/C/D	C/D
6.8	685		A/B	A/B	A/B/C	B/C	C/D	D
10	106	A/B	A/B/P	A/B/C	B/C	B/C/D	C/D/Y	D/E
15	156	A/P	A/B/C	B/C	B/C	C/D/Y	D/Y	E
22	226	A/B/C	A/B/C	B/C/D	B/C/D/Y	C/D/Y	D/E	
33	336	A/B	B/C	B/C/D/Y	C/D/Y	D	D/E	
47	476	A/B/C	B/C/D	C/D/Y	D/Y	D/E	E	
68	686	B/C	B/C/D/Y	C/D/Y	D/E	E		
100	107	B/C/D/Y	C/D/Y	D/E	E	E		
150	157	C/D/Y	D/E/Y	D/E				
220	227	C/D/Y	D/E	E				
330	337	D/E	D/E					
470	477	D/E						
680	687	D/E						

Note for designers - for the highlighted ratings, higher voltage options are now available in the same case size and are recommended for new designs.

Released ratings

Note: Voltage ratings are minimum values. AVX reserves the right to supply higher voltage ratings in the same case size, to the same reliability standards.

TAJ Automotive Range

Standard Tantalum - Automotive Product Range



RATINGS & PART NUMBER REFERENCE

AVX Part No.	Case Size	Capacitance (µF)	Rated Voltage (V)	Rated Temperature (°C)	Category Voltage (V)	Category Temperature (°C)	DCL Max. (µA)	DF Max. (%)	ESR Max. @ 100kHz (Ω)	100kHz RMS Current (mA)			MSL
										25°C	85°C	125°C	
6.3 Volt @ 85°C													
TAJA335*006TNJ	A	3.3	6.3	85	4	125	0.5	6	7	104	93	41	1
TAJA106*006TNJ	A	10	6.3	85	4	125	0.6	6	4	137	123	55	1
TAJB106*006TNJ	B	10	6.3	85	4	125	0.5	6	3	168	151	67	1
TAJA156*006TNJ	A	15	6.3	85	4	125	0.9	6	3.5	146	132	59	1
TAJP156*006TNJ	P	15	6.3	85	4	125	0.9	8	3.5	131	118	52	1
TAJA226*006TNJ	A	22	6.3	85	4	125	1.4	6	3	158	142	63	1
TAJB226*006TNJ	B	22	6.3	85	4	125	1.4	6	2.5	184	166	74	1
TAJC226*006TNJ	C	22	6.3	85	4	125	1.4	6	2	235	211	94	1
TAJA336*006TNJ	A	33	6.3	85	4	125	2.1	8	2.2	185	166	74	1
TAJB336*006TNJ	B	33	6.3	85	4	125	2.1	6	2.2	197	177	79	1
TAJA476*006TNJ	A	47	6.3	85	4	125	2.8	10	1.6	217	195	87	1
TAJB476*006TNJ	B	47	6.3	85	4	125	3	6	2	206	186	82	1
TAJC476*006TNJ	C	47	6.3	85	4	125	3	6	1.6	262	236	105	1
TAJB686*006TNJ	B	68	6.3	85	4	125	4	8	0.9	307	277	123	1
TAJC686*006TNJ	C	68	6.3	85	4	125	4.3	6	1.5	271	244	108	1
TAJB107*006TNJ	B	100	6.3	85	4	125	6.3	10	1.4	246	222	99	1
TAJC107*006TNJ	C	100	6.3	85	4	125	6.3	6	0.9	350	315	140	1
TAJD107*006TNJV	D	100	6.3	85	4	125	6.3	6	0.9	408	367	163	3
TAJY107*006TNJV	Y	100	6.3	85	4	125	6.3	6	0.7	423	380	169	3
TAJC157*006TNJ	C	150	6.3	85	4	125	9.5	6	1.3	291	262	116	1
TAJD157*006TNJV	D	150	6.3	85	4	125	9.5	6	0.9	408	367	163	3
TAJY157*006TNJV	Y	150	6.3	85	4	125	9.5	6	0.4	559	503	224	3
TAJC227*006TNJ	C	220	6.3	85	4	125	8.8	8	1.2	303	272	121	1
TAJD227*006TNJV	D	220	6.3	85	4	125	13.9	8	0.4	612	551	245	3
TAJY227*006TNJV	Y	220	6.3	85	4	125	13.9	8	0.7	423	380	169	3
TAJD337*006TNJV	D	330	6.3	85	4	125	20.8	8	0.4	612	551	245	3
TAJE337*006TNJV	E	330	6.3	85	4	125	20.8	8	0.4	642	578	257	3
TAJD477*006TNJV	D	470	6.3	85	4	125	28	12	0.4	612	551	245	3
TAJE477*006TNJV	E	470	6.3	85	4	125	28	10	0.4	642	578	257	3
TAJD687*006TNJV	D	680	6.3	85	4	125	40.8	20	0.5	548	493	219	3
TAJE687*006TNJV	E	680	6.3	85	4	125	42.8	10	0.5	574	517	230	3
10 Volt @ 85°C													
TAJA225*010TNJ	A	2.2	10	85	7	125	0.5	6	7	104	93	41	1
TAJA475*010TNJ	A	4.7	10	85	7	125	0.5	6	5	122	110	49	1
TAJB475*010TNJ	B	4.7	10	85	7	125	0.5	6	4	146	131	58	1
TAJA685*010TNJ	A	6.8	10	85	7	125	0.7	6	4	137	123	55	1
TAJB685*010TNJ	B	6.8	10	85	7	125	0.7	6	3	168	151	67	1
TAJA106*010TNJ	A	10	10	85	7	125	1	6	3	158	142	63	1
TAJB106*010TNJ	B	10	10	85	7	125	1	6	2.1	201	181	80	1
TAJP106*010TNJ	P	10	10	85	7	125	1	8	6	100	90	40	1
TAJA156*010TNJ	A	15	10	85	7	125	1.5	6	3.2	153	138	61	1
TAJB156*010TNJ	B	15	10	85	7	125	1.5	6	2.8	174	157	70	1
TAJC156*010TNJ	C	15	10	85	7	125	1.5	6	2	235	211	94	1
TAJA226*010TNJ	A	22	10	85	7	125	2.2	8	3	158	142	63	1
TAJB226*010TNJ	B	22	10	85	7	125	2.2	6	2.4	188	169	75	1
TAJC226*010TNJ	C	22	10	85	7	125	2.2	6	1.8	247	222	99	1
TAJB336*010TNJ	B	33	10	85	7	125	3.3	6	1.8	217	196	87	1
TAJC336*010TNJ	C	33	10	85	7	125	3.3	6	1.6	262	236	105	1
TAJB476*010TNJ	B	47	10	85	7	125	4.7	8	1	292	262	117	1
TAJC476*010TNJ	C	47	10	85	7	125	4.7	6	1.2	303	272	121	1
TAJD476*010TNJV	D	47	10	85	7	125	4.7	6	0.4	612	551	245	3
TAJB686*010TNJ	B	68	10	85	7	125	6.8	8	1.4	246	222	99	1
TAJC686*010TNJ	C	68	10	85	7	125	6.8	6	1.3	291	262	116	1
TAJD686*010TNJV	D	68	10	85	7	125	6.8	6	0.9	408	367	163	3
TAJY686*010TNJV	Y	68	10	85	7	125	6.8	6	0.9	373	335	149	3
TAJC107*010TNJ	C	100	10	85	7	125	10	8	1.2	303	272	121	1
TAJD107*010TNJV	D	100	10	85	7	125	10	6	0.9	408	367	163	3
TAJY107*010TNJV	Y	100	10	85	7	125	10	6	0.9	373	335	149	3
TAJD157*010TNJV	D	150	10	85	7	125	15	8	0.9	408	367	163	3
TAJE157*010TNJV	E	150	10	85	7	125	15	8	0.9	428	385	171	3
TAJY157*010TNJV	Y	150	10	85	7	125	15	6	1.2	323	290	129	3
TAJD227*010TNJV	D	220	10	85	7	125	22	8	0.5	548	493	219	3
TAJE227*010TNJV	E	220	10	85	7	125	22	8	0.5	574	517	230	3
TAJD337*010TNJV	D	330	10	85	7	125	33	8	0.9	408	367	163	3
TAJE337*010TNJV	E	330	10	85	7	125	33	8	0.9	428	385	171	3
16 Volt @ 85°C													
TAJA105*016TNJ	A	1	16	85	10	125	0.5	4	11	83	74	33	1
TAJA225*016TNJ	A	2.2	16	85	10	125	0.5	6	6.5	107	97	43	1
TAJA335*016TNJ	A	3.3	16	85	10	125	0.5	6	5	122	110	49	1
TAJB335*016TNJ	B	3.3	16	85	10	125	0.5	6	4.5	137	124	55	1
TAJA475*016TNJ	A	4.7	16	85	10	125	0.8	6	4	137	123	55	1



TAJ Automotive Range

Standard Tantalum - Automotive Product Range



RATINGS & PART NUMBER REFERENCE

AVX Part No.	Case Size	Capacitance (µF)	Rated Voltage (V)	Rated Temperature (°C)	Category Voltage (V)	Category Temperature (°C)	DCL Max. (µA)	DF Max. (%)	ESR Max. @ 100kHz (Ω)	100kHz RMS Current (mA)			MSL
										25°C	85°C	125°C	
TAJB475*016TNJ	B	4.7	16	85	10	125	0.8	6	3.5	156	140	62	1
TAJA685*016TNJ	A	6.8	16	85	10	125	1.1	6	3.5	146	132	59	1
TAJB685*016TNJ	B	6.8	16	85	10	125	1.1	6	2.5	184	166	74	1
TAJA106*016TNJ	A	10	16	85	10	125	1.6	6	3	158	142	63	1
TAJB106*016TNJ	B	10	16	85	10	125	1.6	6	2.5	184	166	74	1
TAJC106*016TNJ	C	10	16	85	10	125	1.6	6	2	235	211	94	1
TAJB156*016TNJ	B	15	16	85	10	125	2.4	6	2.5	184	166	74	1
TAJC156*016TNJ	C	15	16	85	10	125	2.4	6	1.8	247	222	99	1
TAJB226*016TNJ	B	22	16	85	10	125	3.5	6	2.3	192	173	77	1
TAJC226*016TNJ	C	22	16	85	10	125	3.5	6	1	332	298	133	1
TAJD226*016TNJV	D	22	16	85	10	125	3.5	6	1.1	369	332	148	3
TAJB336*016TNJ	B	33	16	85	10	125	5.3	8	2.1	201	181	80	1
TAJC336*016TNJ	C	33	16	85	10	125	5.3	6	1.5	271	244	108	1
TAJD336*016TNJV	D	33	16	85	10	125	5.3	6	0.9	408	367	163	3
TAJY336*016TNJV	Y	33	16	85	10	125	5.3	6	0.9	373	335	149	3
TAJC476*016TNJ	C	47	16	85	10	125	7.5	6	0.5	469	422	188	1
TAJD476*016TNJV	D	47	16	85	10	125	7.5	6	0.9	408	367	163	3
TAJY476*016TNJV	Y	47	16	85	10	125	7.5	6	0.7	423	380	169	3
TAJC686*016TNJ	C	68	16	85	10	125	10.9	6	1.3	291	262	116	1
TAJD686*016TNJV	D	68	16	85	10	125	10.9	6	0.9	408	367	163	3
TAJY686*016TNJV	Y	68	16	85	10	125	10.9	6	0.9	373	335	149	3
TAJD107*016TNJV	D	100	16	85	10	125	16	6	0.6	500	450	200	3
TAJE107*016TNJV	E	100	16	85	10	125	16	6	0.9	428	385	171	3
TAJD157*016TNJV	D	150	16	85	10	125	24	6	0.9	408	367	163	3
TAJE157*016TNJV	E	150	16	85	10	125	24	8	0.3	742	667	297	3
TAJE227*016TNJV	E	220	16	85	10	125	35.2	10	0.5	574	517	230	3
20 Volt @ 85°C													
TAJA105*020TNJ	A	1	20	85	13	125	0.5	4	9	91	82	37	1
TAJA155*020TNJ	A	1.5	20	85	13	125	0.5	6	6.5	107	97	43	1
TAJA225*020TNJ	A	2.2	20	85	13	125	0.5	6	5.3	119	107	48	1
TAJB225*020TNJ	B	2.2	20	85	13	125	0.5	6	3.5	156	140	62	1
TAJA335*020TNJ	A	3.3	20	85	13	125	0.7	6	4.5	129	116	52	1
TAJB335*020TNJ	B	3.3	20	85	13	125	0.7	6	3	168	151	67	1
TAJA475*020TNJ	A	4.7	20	85	13	125	0.9	6	4	137	123	55	1
TAJB475*020TNJ	B	4.7	20	85	13	125	0.9	6	3	168	151	67	1
TAJA685*020TNJ	A	6.8	20	85	13	125	1.4	6	2.4	177	159	71	1
TAJB685*020TNJ	B	6.8	20	85	13	125	1.4	6	2.5	184	166	74	1
TAJC685*020TNJ	C	6.8	20	85	13	125	1.4	6	2	235	211	94	1
TAJB106*020TNJ	B	10	20	85	13	125	2	6	2.1	201	181	80	1
TAJC106*020TNJ	C	10	20	85	13	125	2	6	1.2	303	272	121	1
TAJB156*020TNJ	B	15	20	85	13	125	3	6	2	206	186	82	1
TAJC156*020TNJ	C	15	20	85	13	125	3	6	1.7	254	229	102	1
TAJB226*020TNJ	B	22	20	85	13	125	4.4	6	1.8	217	196	87	1
TAJC226*020TNJ	C	22	20	85	13	125	4.4	6	1.6	262	236	105	1
TAJD226*020TNJV	D	22	20	85	13	125	4.4	6	0.9	408	367	163	3
TAJY226*020TNJV	Y	22	20	85	13	125	4.4	6	0.9	373	335	149	3
TAJC336*020TNJ	C	33	20	85	13	125	6.6	6	1.5	271	244	108	1
TAJD336*020TNJV	D	33	20	85	13	125	6.6	6	0.9	408	367	163	3
TAJY336*020TNJV	Y	33	20	85	13	125	6.6	6	0.6	456	411	183	3
TAJD476*020TNJV	D	47	20	85	13	125	9.4	6	0.9	408	367	163	3
TAJY476*020TNJV	Y	47	20	85	13	125	9.4	6	0.9	373	335	149	3
TAJD686*020TNJV	D	68	20	85	13	125	13.6	6	0.4	612	551	245	3
TAJE686*020TNJV	E	68	20	85	13	125	13.6	6	0.9	428	385	171	3
TAJE107*020TNJV	E	100	20	85	13	125	20	6	0.4	642	578	257	3
25 Volt @ 85°C													
TAJA474*025TNJ	A	0.47	25	85	17	125	0.5	4	14	73	66	29	1
TAJA684*025TNJ	A	0.68	25	85	17	125	0.5	4	10	87	78	35	1
TAJA105*025TNJ	A	1	25	85	17	125	0.5	4	8	97	87	39	1
TAJA155*025TNJ	A	1.5	25	85	17	125	0.5	6	7.5	100	90	40	1
TAJB155*025TNJ	B	1.5	25	85	17	125	0.5	6	5	130	117	52	1
TAJA225*025TNJ	A	2.2	25	85	17	125	0.6	6	7	104	93	41	1
TAJB225*025TNJ	B	2.2	25	85	17	125	0.6	6	4.5	137	124	55	1
TAJA335*025TNJ	A	3.3	25	85	17	125	0.8	6	3.7	142	128	57	1
TAJB335*025TNJ	B	3.3	25	85	17	125	0.8	6	3.5	156	140	62	1
TAJB475*025TNJ	B	4.7	25	85	17	125	1.2	6	1.5	238	214	95	1
TAJC475*025TNJ	C	4.7	25	85	17	125	1.2	6	2.4	214	193	86	1
TAJB685*025TNJ	B	6.8	25	85	17	125	1.7	6	2.8	174	157	70	1
TAJC685*025TNJ	C	6.8	25	85	17	125	1.7	6	2	235	211	94	1
TAJB106*025TNJ	B	10	25	85	17	125	2.5	6	2.5	184	166	74	1
TAJC106*025TNJ	C	10	25	85	17	125	2.5	6	1.8	247	222	99	1
TAJD106*025TNJV	D	10	25	85	17	125	2.5	6	1.2	354	318	141	3
TAJC156*025TNJ	C	15	25	85	17	125	3.8	6	1.6	262	236	105	1



The Important Information/Disclaimer is incorporated in the catalog where these specifications came from or available online at www.avx.com/disclaimer/ by reference and should be reviewed in full before placing any order.

TAJ Automotive Range

Standard Tantalum - Automotive Product Range



RATINGS & PART NUMBER REFERENCE

AVX Part No.	Case Size	Capacitance (µF)	Rated Voltage (V)	Rated Temperature (°C)	Category Voltage (V)	Category Temperature (°C)	DCL Max. (µA)	DF Max. (%)	ESR Max. @ 100kHz (Ω)	100kHz RMS Current (mA)			MSL
										25°C	85°C	125°C	
TAJD156*025TNJV	D	15	25	85	17	125	3.8	6	1	387	349	155	3
TAJY156*025TNJV	Y	15	25	85	17	125	3.8	6	1	354	318	141	3
TAJC226*025TNJ	C	22	25	85	17	125	5.5	6	1.4	280	252	112	1
TAJD226*025TNJV	D	22	25	85	17	125	5.5	6	0.9	408	367	163	3
TAJY226*025TNJV	Y	22	25	85	17	125	5.5	6	0.8	395	356	158	3
TAJD336*025TNJV	D	33	25	85	17	125	8.3	6	0.9	408	367	163	3
TAJD476*025TNJV	D	47	25	85	17	125	11.8	6	0.9	408	367	163	3
TAJE476*025TNJV	E	47	25	85	17	125	11.8	6	0.9	428	385	171	3
TAJE686*025TNJV	E	68	25	85	17	125	17	6	0.9	428	385	171	3
TAJE107*025TNJV	E	100	25	85	17	125	25	10	0.3	742	667	297	3
35 Volt @ 85°C													
TAJA334*035TNJ	A	0.33	35	85	23	125	0.5	4	15	71	64	28	1
TAJA474*035TNJ	A	0.47	35	85	23	125	0.5	4	12	79	71	32	1
TAJA684*035TNJ	A	0.68	35	85	23	125	0.5	4	8	97	87	39	1
TAJA105*035TNJ	A	1	35	85	23	125	0.5	4	7.5	100	90	40	1
TAJB105*035TNJ	B	1	35	85	23	125	0.5	4	6.5	114	103	46	1
TAJA155*035TNJ	A	1.5	35	85	23	125	0.5	6	7.5	100	90	40	1
TAJB155*035TNJ	B	1.5	35	85	23	125	0.5	6	5.2	128	115	51	1
TAJB225*035TNJ	B	2.2	35	85	23	125	0.8	6	4.2	142	128	57	1
TAJC225*035TNJ	C	2.2	35	85	23	125	0.8	6	3.5	177	160	71	1
TAJB335*035TNJ	B	3.3	35	85	23	125	1.2	6	3.5	156	140	62	1
TAJC335*035TNJ	C	3.3	35	85	23	125	1.2	6	2.5	210	189	84	1
TAJB475*035TNJ	B	4.7	35	85	23	125	1.6	6	3.1	166	149	66	1
TAJC475*035TNJ	C	4.7	35	85	23	125	1.6	6	2.2	224	201	89	1
TAJD475*035TNJV	D	4.7	35	85	23	125	1.6	6	1.5	316	285	126	3
TAJC685*035TNJ	C	6.8	35	85	23	125	2.4	6	1.8	247	222	99	1
TAJD685*035TNJV	D	6.8	35	85	23	125	2.4	6	1.3	340	306	136	3
TAJC106*035TNJ	C	10	35	85	23	125	3.5	6	1.6	262	236	105	1
TAJD106*035TNJV	D	10	35	85	23	125	3.5	6	1	387	349	155	3
TAJY106*035TNJV	Y	10	35	85	23	125	3.5	6	1	354	318	141	3
TAJD156*035TNJV	D	15	35	85	23	125	5.3	6	0.9	408	367	163	3
TAJY156*035TNJV	Y	15	35	85	23	125	5.3	6	0.6	456	411	183	3
TAJD226*035TNJV	D	22	35	85	23	125	7.7	6	0.9	408	367	163	3
TAJE226*035TNJV	E	22	35	85	23	125	7.7	6	0.5	574	517	230	3
TAJD336*035TNJV	D	33	35	85	23	125	11.6	6	0.9	408	367	163	3
TAJE336*035TNJV	E	33	35	85	23	125	11.6	6	0.9	428	385	171	3
TAJE476*035TNJV	E	47	35	85	23	125	16.5	6	0.9	428	385	171	3
50 Volt @ 85°C													
TAJA224*050TNJ	A	0.22	50	85	33	125	0.5	4	18	65	58	26	1
TAJA334*050TNJ	A	0.33	50	85	33	125	0.5	4	17	66	60	27	1
TAJA474*050TNJ	A	0.47	50	85	33	125	0.5	4	9.5	89	80	36	1
TAJB474*050TNJ	B	0.47	50	85	33	125	0.5	4	9.5	95	85	38	1
TAJB684*050TNJ	B	0.68	50	85	33	125	0.5	4	8	103	93	41	1
TAJB105*050TNJ	B	1	50	85	33	125	0.5	6	7	110	99	44	1
TAJC105*050TNJ	C	1	50	85	33	125	0.5	4	5.5	141	127	57	1
TAJC155*050TNJ	C	1.5	50	85	33	125	0.8	6	4.5	156	141	63	1
TAJC225*050TNJ	C	2.2	50	85	33	125	1.1	8	2.5	210	189	84	1
TAJD225*050TNJV	D	2.2	50	85	33	125	1.1	6	2.5	245	220	98	3
TAJC335*050TNJ	C	3.3	50	85	33	125	1.6	6	2.5	210	189	84	1
TAJD335*050TNJV	D	3.3	50	85	33	125	1.7	6	2	274	246	110	3
TAJC475*050TNJ	C	4.7	50	85	33	125	2.4	6	1.4	280	252	112	1
TAJD475*050TNJV	D	4.7	50	85	33	125	2.4	6	1.4	327	295	131	3
TAJD685*050TNJV	D	6.8	50	85	33	125	3.4	6	1	387	349	155	3
TAJD106*050TNJV	D	10	50	85	33	125	5	6	0.8	433	390	173	3
TAJE106*050TNJV	E	10	50	85	33	125	5	6	1	406	366	162	3
TAJE156*050TNJV	E	15	50	85	33	125	7.5	6	0.6	524	472	210	3

Moisture Sensitivity Level (MSL) is defined according to J-STD-020

*Please use "U" instead of "T" in the suffix letter for 13" reel packaging

Please use specific PN for automotive version – see "HOW TO ORDER".

All technical data relates to an ambient temperature of +25°C. Capacitance and DF are measured at 120Hz, 0.5V RMS with a maximum DC bias of 2.2 volts.

DCL is measured at rated voltage after 5 minutes.

For typical weight and composition see page 274.

NOTE: AVX reserves the right to supply higher voltage ratings or tighter tolerance part in the same case size, to the same reliability standards.

TAJ Automotive Range

Standard Tantalum - Automotive Product Range

QUALIFICATION TABLE

TEST	TAJ automotive series (Temperature range -55°C to +125°C)										
	Condition			Characteristics							
Endurance	Apply rated voltage (Ur) at 85°C and / or category voltage (Uc) at 125°C for 2000 hours through a circuit impedance of $\leq 0.1\Omega/V$. Stabilize at room temperature for 1-2 hours before measuring.			Visual examination	no visible damage						
				DCL	1.25 x initial limit						
				$\Delta C/C$	within $\pm 10\%$ of initial value						
				DF	initial limit						
				ESR	initial limit						
Storage Life	Store at 125°C, no voltage applied, for 2000 hours. Stabilize at room temperature for 1-2 hours before measuring.			Visual examination	no visible damage						
				DCL	1.25 x initial limit						
				$\Delta C/C$	within $\pm 10\%$ of initial value						
				DF	initial limit						
				ESR	initial limit						
Humidity	Store at 65°C and 95% relative humidity for 500 hours, with no applied voltage. Stabilize at room temperature and humidity for 1-2 hours before measuring.			Visual examination	no visible damage						
				DCL	1.5 x initial limit						
				$\Delta C/C$	within $\pm 10\%$ of initial value						
				DF	1.2 x initial limit						
				ESR	initial limit						
Biased Humidity	Apply rated voltage (Ur) at 85°C, 85% relative humidity for 1000 hours. Stabilize at room temperature and humidity for 1-2 hours before measuring.			Visual examination	no visible damage						
				DCL	2 x initial limit						
				$\Delta C/C$	within $\pm 10\%$ of initial value						
				DF	1.2 x initial limit						
				ESR	initial limit						
Temperature Stability	Step	Temperature°C	Duration(min)		+20°C	-55°C	+20°C	+85°C	+125°C	+20°C	
	1	+20	15	DCL	IL*	n/a	IL*	10 x IL*	12.5 x IL*	IL*	
	2	-55	15	$\Delta C/C$	n/a	+0/-10%	$\pm 5\%$	+10/-0%	+12/-0%	$\pm 5\%$	
	3	+20	15	DF	IL*	1.5 x IL*	IL*	1.5 x IL*	2 x IL*	IL*	
	4	+85	15	ESR	IL*	2 x IL*	IL*	IL*	IL*	IL*	
	5	+125	15								
	6	+20	15								
Surge Voltage	Apply 1.3x category voltage (Uc) at 125°C for 1000 cycles of duration 6 min (30 sec charge, 5 min 30 sec discharge) through a charge / discharge resistance of 1000 Ω			Visual examination	no visible damage						
				DCL	initial limit						
				$\Delta C/C$	within $\pm 5\%$ of initial value						
				DF	initial limit						
				ESR	initial limit						
Mechanical Shock	MIL-STD-202, Method 213, Condition F			Visual examination	no visible damage						
				DCL	initial limit						
				$\Delta C/C$	within $\pm 5\%$ of initial value						
				DF	initial limit						
				ESR	initial limit						
Vibration	MIL-STD-202, Method 204, Condition D			Visual examination	no visible damage						
				DCL	initial limit						
				$\Delta C/C$	within $\pm 5\%$ of initial value						
				DF	initial limit						
				ESR	initial limit						

*Initial Limit

TAJ Automotive Range

Standard Tantalum - Automotive Product Range

AVX SOLID ELECTROLYTIC CAPACITOR ROADMAP

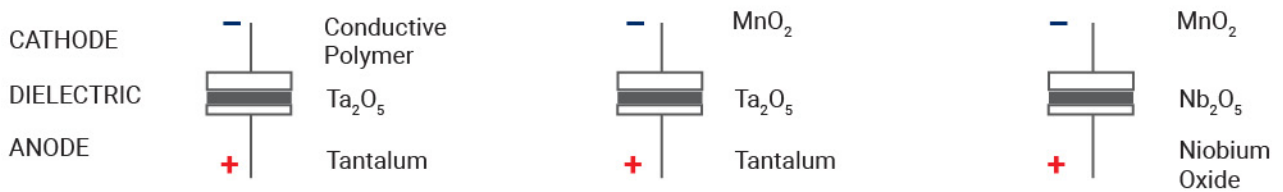
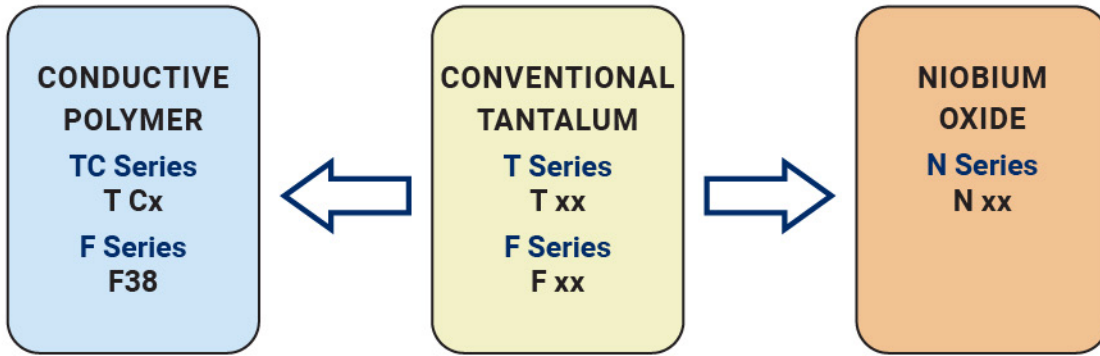

FIVE CAPACITOR CONSTRUCTION STYLES

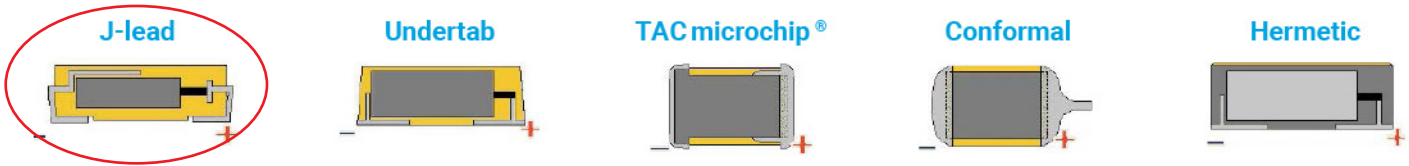

SERIES LINE UP: CONVENTIONAL SMD MnO₂

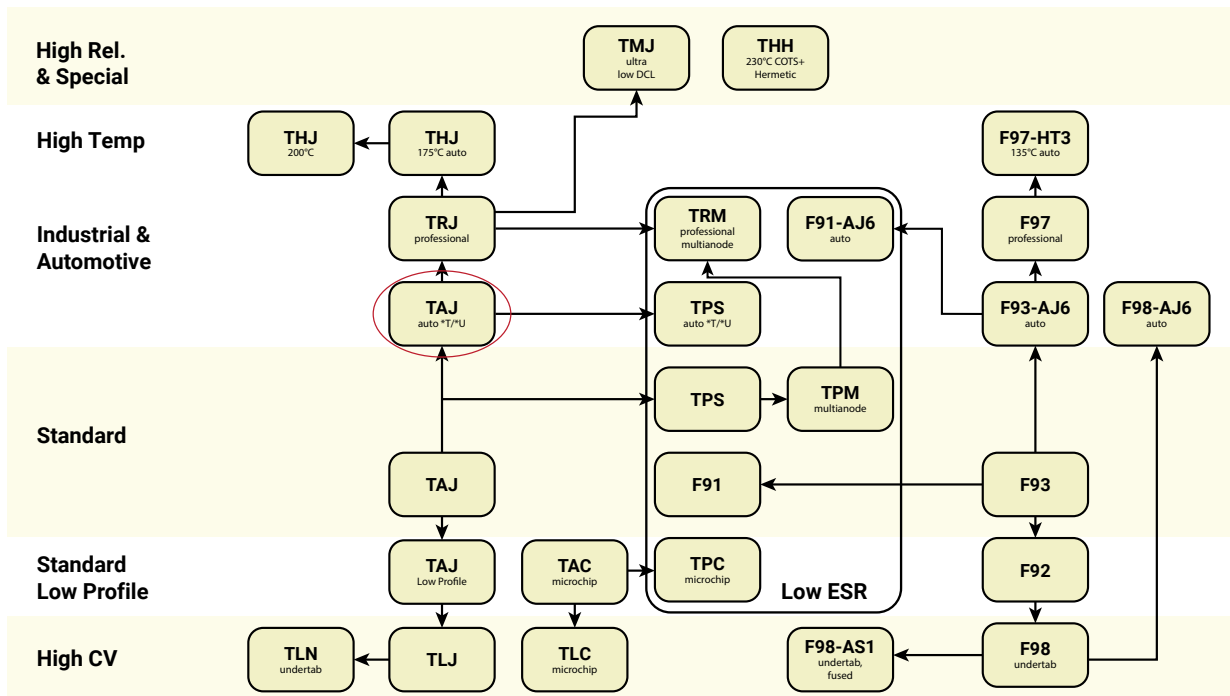

F92 Series

Resin-Molded Chip, Low Profile J-Lead



FEATURES

- Compliant to the RoHS3 directive 2015/863/EU
- SMD J-Lead
- Low Profile Case Sizes
- 100% Surge Current Tested

APPLICATIONS

- Handheld Electronics
- USB Accessories



CASE DIMENSIONS:

millimeters (inches)

Code	EIA Code	EIA Metric	L	W ₁	W ₂	H	S
A	1206	3216-12	3.20 ± 0.20 (0.126 ± 0.008)	1.60 ± 0.20 (0.063 ± 0.008)	1.20 ± 0.10 (0.047 ± 0.004)	1.10 ± 0.10 (0.043 ± 0.004)	0.80 ± 0.20 (0.031 ± 0.008)
B	1311	3428-12	3.40 ± 0.20 (0.134 ± 0.008)	2.80 ± 0.20 (0.110 ± 0.008)	2.30 ± 0.10 (0.091 ± 0.004)	1.10 ± 0.10 (0.043 ± 0.004)	0.80 ± 0.20 (0.031 ± 0.008)
P	0805	2012-12	2.00 ± 0.20 (0.079 ± 0.008)	1.25 ± 0.10 (0.049 ± 0.004)	0.90 ± 0.10 (0.035 ± 0.004)	1.10 ± 0.10 (0.043 ± 0.004)	0.50 ± 0.20 (0.020 ± 0.008)

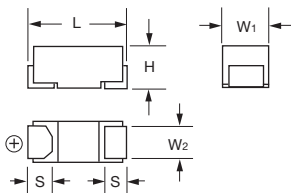

MARKING

P CASE

*Rated Capacitance Code



Rated Voltage Code

4V	G	16V	C	35V	V
6.3V	J	20V	D		
10V	A	25V	E		

A CASE

Rated Capacitance Code



Rated Voltage Code

B CASE

Rated Capacitance (µF)



Rated Voltage (V)

*Capacitance code of "P" case products are as shown below.

HOW TO ORDER

F92

Type

0J

Rated Voltage

106

Capacitance Code
pF code: 1st two digits represent significant figures, 3rd digit represents multiplier (number of zeros to follow)

M

Tolerance
K = ±10%
M = ±20%

P

Case Size
See table above

□

Packaging
See Tape & Reel Packaging Section

LZT

Specification Suffix
Rated temperature 60°C only

TECHNICAL SPECIFICATIONS

Category Temperature Range	-55 to +125°C	
Rated Temperature	+85°C	
Capacitance Tolerance	±20%, ±10% at 120Hz	
Dissipation Factor	Refer to next page	
ESR 100kHz	Refer to next page	
Leakage Current	After 1 minute's application of rated voltage, leakage current at 20°C is not more than 0.01CV or 0.5µA, whichever is greater. After 1 minute's application of rated voltage, leakage current at 85°C is not more than 0.1CV or 5µA, whichever is greater. After 1 minute's application of derated voltage, leakage current at 125°C is not more than 0.125CV or 6.3µA, whichever is greater.	
Capacitance Change By Temperature	P Case	A, B Case
	+20% Max. at +125°C	+15% Max. at +125°C
	+15% Max. at +85°C	+10% Max. at +85°C
	-15% Max. at -55°C	-10% Max. at -55°C

F92 Series

Resin-Molded Chip, Low Profile J-Lead



CAPACITANCE AND RATED VOLTAGE RANGE (LETTER DENOTES CASE SIZE)

Capacitance		Rated Voltage							*Cap Code
µF	Code	4V (0G)	6.3V (0J)	10V (1A)	16V (1C)	20V (1D)	25V (1E)	35V (1V)	
0.22	224							A	J
0.33	334							A	N
0.47	474				P	A/P		A	S
0.68	684				P	A			W
1.0	105			P	P	A/P	P	A	A
1.5	155			P		A			E
2.2	225		P	P	A/P		A/B	B	J
3.3	335	P	P	A/P	A				N
4.7	475	P	P	A/P	A/B		B		S
6.8	685	P	P	P	B				w
10	106	P	A/P	A/P ^(M)	B				a
15	156	P	P ^(M)	A					e
22	226	A	A/P ^(M)	B					J
33	336		B						n
47	476	B	B						s
68	686								w
100	107	A ^(M) /B							A

Released ratings ^(M tolerance only)

**Rated temperature 60°C only. Please contact AVX when you need detail spec.

Please contact to your local AVX sales office when these series are being designed in your application.

RATINGS & PART NUMBER REFERENCE

AVX Part No.	Case Size	Capacitance (µF)	Rated Voltage (V)	DCL (µA)	DF @ 120Hz (%)	ESR @ 100kHz (Ω)	100kHz RMS Current (mA)				*1 ΔC/C (%)	MSL
							25°C	60°C	85°C	125°C		
4 Volt												
F920G335#PA	P	3.3	4	0.5	8	12.0	50	-	45	20	*	1
F920G475#PA	P	4.7	4	0.5	8	6.0	71	-	64	28	*	1
F920G685#PA	P	6.8	4	0.5	10	6.0	71	-	64	28	*	1
F920G106#PA	P	10	4	0.5	10	6.0	71	-	64	28	*	1
F920G156#PA	P	15	4	0.6	10	5.0	77	-	70	31	*	1
F920G226#AA	A	22	4	0.9	12	2.8	146	-	132	59	*	1
F920G476#BA	B	47	4	1.9	12	1.7	210	-	189	84	*	1
F920G107MAA	A	100	4	4.0	30	2.8	146	-	132	59	±15	1
F920G107#BA	B	100	4	4.0	18	1.3	240	-	216	96	*	1
6.3 Volt												
F920J225#PA	P	2.2	6.3	0.5	8	12.0	50	-	45	20	*	1
F920J335#PA	P	3.3	6.3	0.5	8	12.0	50	-	45	20	*	1
F920J475#PA	P	4.7	6.3	0.5	8	6.0	71	-	64	28	*	1
F920J685#PA	P	6.8	6.3	0.5	10	6.0	71	-	64	28	*	1
F920J106#AA	A	10	6.3	0.6	8	4.0	122	-	110	49	*	1
F920J106#PA	P	10	6.3	0.6	10	6.0	71	-	64	28	*	1
F920J156MPA	P	15	6.3	0.9	10	6.0	71	-	64	28	*	1
F920J226#AA	A	22	6.3	1.4	12	2.8	146	-	132	59	*	1
F920J226MPA	P	22	6.3	1.4	20	5.0	77	-	70	31	*	1
F920J336#BA	B	33	6.3	2.1	12	1.7	210	-	189	84	*	1
F920J476#BA	B	47	6.3	3.0	12	1.7	210	-	189	84	*	3
10 Volt												
F921A105#PA	P	1	10	0.5	8	12.0	50	-	45	20	*	1
F921A155#PA	P	1.5	10	0.5	8	12.0	50	-	45	20	*	1
F921A225#PA	P	2.2	10	0.5	8	12.0	50	-	45	20	*	1
F921A335#AA	A	3.3	10	0.5	6	7.0	93	-	83	37	*	1
F921A335#PA	P	3.3	10	0.5	8	12.0	50	-	45	20	*	1
F921A475#AA	A	4.7	10	0.5	6	4.0	122	-	110	49	*	1
F921A475#PA	P	4.7	10	0.5	8	6.0	71	-	64	28	*	1
F921A685#PA	P	6.8	10	0.7	8	6.0	71	-	64	28	*	1
F921A106#AA	A	10	10	1.0	8	4.0	122	-	110	49	*	1
F921A106MPA	P	10	10	1.0	14	6.0	71	-	64	28	*	1
F921A156#AA	A	15	10	1.5	8	4.0	122	-	110	49	*	1
F921A226#BA	B	22	10	2.2	8	1.9	199	-	179	79	*	3



F92 Series

Resin-Molded Chip, Low Profile J-Lead



RATINGS & PART NUMBER REFERENCE

AVX Part No.	Case Size	Capacitance (μF)	Rated Voltage (V)	DCL (μA)	DF @ 120Hz (%)	ESR @ 100kHz (Ω)	100kHz RMS Current (mA)				*1 ΔC/C (%)	MSL
							25°C	60°C	85°C	125°C		
16 Volt												
F921C474#PA	P	0.47	16	0.5	8	20.0	39	–	35	15	*	1
F921C684#PA	P	0.68	16	0.5	8	12.0	50	–	45	20	*	1
F921C105#PA	P	1	16	0.5	8	12.0	50	–	45	20	*	1
F921C225#AA	A	2.2	16	0.5	6	7.0	93	–	83	37	*	1
F921C225#PA	P	2.2	16	0.5	8	12.0	50	–	45	20	*	1
F921C335#AA	A	3.3	16	0.5	6	7.0	93	–	83	37	*	1
F921C475#AA	A	4.7	16	0.8	6	7.0	93	–	83	37	*	1
F921C475#BA	B	4.7	16	0.8	6	3.0	158	–	142	63	*	1
F921C685#BA	B	6.8	16	1.1	6	3.0	158	–	142	63	*	1
F921C106#BA	B	10	16	1.6	6	2.0	194	–	174	77	*	1
20 Volt												
F921D474#AA	A	0.47	20	0.5	4	10.0	77	–	70	31	*	1
F921D474#PA	P	0.47	20	0.5	8	20.0	39	–	35	15	*	1
F921D684#AA	A	0.68	20	0.5	4	10.0	77	–	70	31	*	1
F921D105#AA	A	1	20	0.5	4	10.0	77	–	70	31	*	1
F921D105#PA	P	1	20	0.5	8	20.0	39	–	35	15	*	1
F921D155#AA	A	1.5	20	0.5	6	7.4	90	–	81	36	*	1
25 Volt												
F921E105#PA	P	1	25	0.5	8	20.0	39	–	35	15	*	1
F921E225#AA	A	2.2	25	0.6	8	10.0	77	–	70	31	±15	1
F921E225#BA	B	2.2	25	0.6	6	4.0	137	–	123	55	*	1
F921E475#BA	B	4.7	25	1.2	6	3.0	158	–	142	63	*	1
35 Volt												
F921V224#AA	A	0.22	35	0.5	4	10.0	77	–	70	31	*	1
F921V334#AA	A	0.33	35	0.5	4	10.0	77	–	70	31	*	1
F921V474#AA	A	0.47	35	0.5	4	10.0	77	–	70	31	*	1
F921V105#AA	A	1	35	0.5	6	10.0	77	–	70	31	*	1
F921V225#BA	B	2.2	35	0.8	6	4.0	137	–	123	55	±10	1

1: ΔC/C Marked “”

Item	P Case (%)	A, B Case (%)
Damp Heat	±20	±10
Temperature cycles	±10	±5
Resistance soldering heat	±10	±5
Surge	±10	±5
Endurance	±10	±10

#: “M” for ±20% tolerance, “K” for ± 10% tolerance. When you need K tolerance for the part numbers which have M tolerance only, please contact to your local AVX sales office.

Moisture Sensitivity Level (MSL) is defined according to J-STD-020.

F92 Series

Resin-Molded Chip, Low Profile J-Lead

QUALIFICATION TABLE

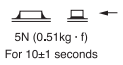
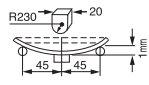
TEST	F92 series (Temperature range -55°C to +125°C)	
	Condition	
Damp Heat (Steady State)	P Case	A, B Case
		At 40°C, 90 to 95% R.H., 500 hours (No voltage applied)
	Capacitance Change Refer to page 28 (*1)	Refer to page 28 (*1)
	Dissipation Factor 150% or less than the initial specified value	Initial specified value or less
	Leakage Current Initial specified value or less	Initial specified value or less
Temperature Cycles	-55°C / +125°C, 30 minutes each, 5 cycles	
	Capacitance Change Refer to page 28 (*1)	Refer to page 28 (*1)
	Dissipation Factor 150% or less than the initial specified value	Initial specified value or less
	Leakage Current Initial specified value or less	Initial specified value or less
Resistance to Soldering Heat	10 seconds reflow at 260°C, 5 seconds immersion at 260°C.	
	Capacitance Change Refer to page 28 (*1)	Refer to page 28 (*1)
	Dissipation Factor 150% or less than the initial specified value	Initial specified value or less
	Leakage Current Initial specified value or less	Initial specified value or less
Surge	After application of surge voltage in series with a 33Ω (For "P" case: 1kΩ) resistor at the rate of 30 seconds ON, 30 seconds OFF, for 1000 successive test cycles at 85°C, capacitors shall meet the characteristic requirements in the table above.	
	Capacitance Change Refer to page 28 (*1)	Refer to page 28 (*1)
	Dissipation Factor 150% or less than the initial specified value	Initial specified value or less
	Leakage Current Initial specified value or less	Initial specified value or less
Endurance	After 2000 hours' application of rated voltage in series with a 3Ω resistor at 85°C, or derated voltage in series with a 3Ω resistor at 125°C, capacitors shall meet the characteristic requirements in the table above.	
	Capacitance Change Refer to page 28 (*1)	Refer to page 28 (*1)
	Dissipation Factor 150% or less than the initial specified value	Initial specified value or less
	Leakage Current Initial specified value or less	Initial specified value or less
Shear Test	After applying the pressure load of 5N for 10±1 seconds horizontally to the center of capacitor side body which has no electrode and has been soldered beforehand on a substrate, there shall be found neither exfoliation nor its sign at the terminal electrode.	 <p>5N (0.51kg · f) For 10±1 seconds</p>
Terminal Strength	Keeping a capacitor surface-mounted on a substrate upside down and supporting the substrate at both of the opposite bottom points 45mm apart from the center of capacitor, the pressure strength is applied with a specified jig at the center of substrate so that the substrate may bend by 1mm as illustrated. Then, there shall be found no remarkable abnormality on the capacitor terminals.	 <p>R230 20 45 45 1mm</p>

F92 Series

Resin-Molded Chip, Low Profile J-Lead

AVX SOLID ELECTROLYTIC CAPACITOR ROADMAP

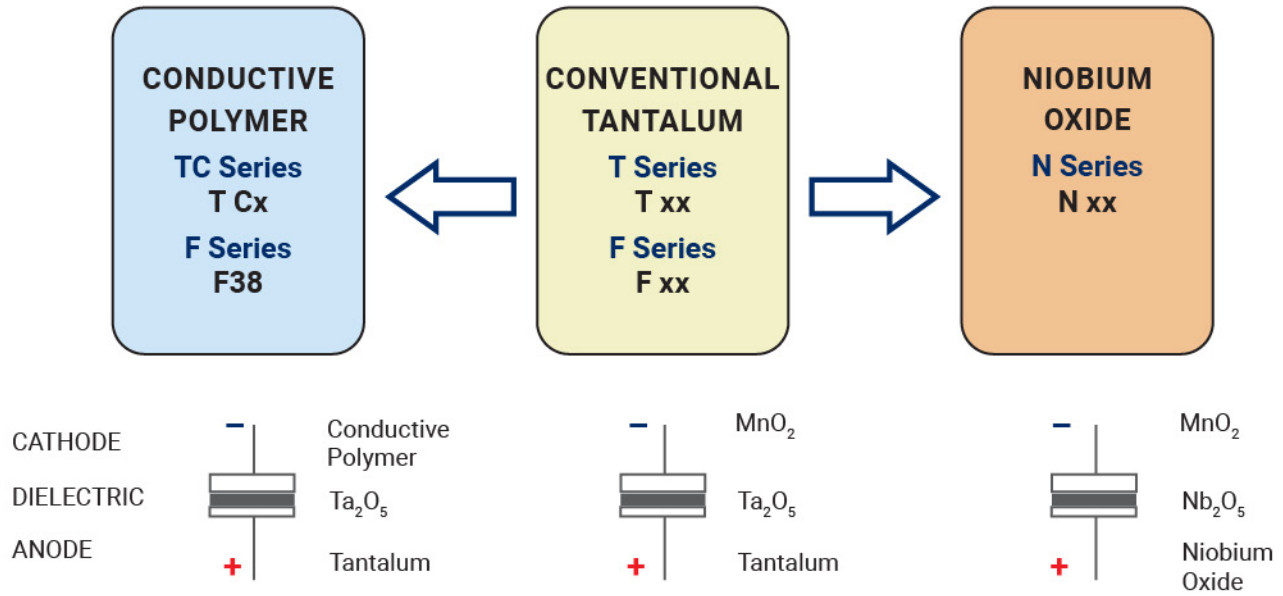

FIVE CAPACITOR CONSTRUCTION STYLES

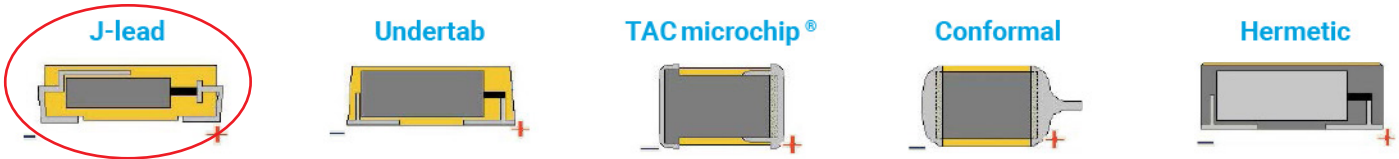

SERIES LINE UP: CONVENTIONAL SMD MnO₂

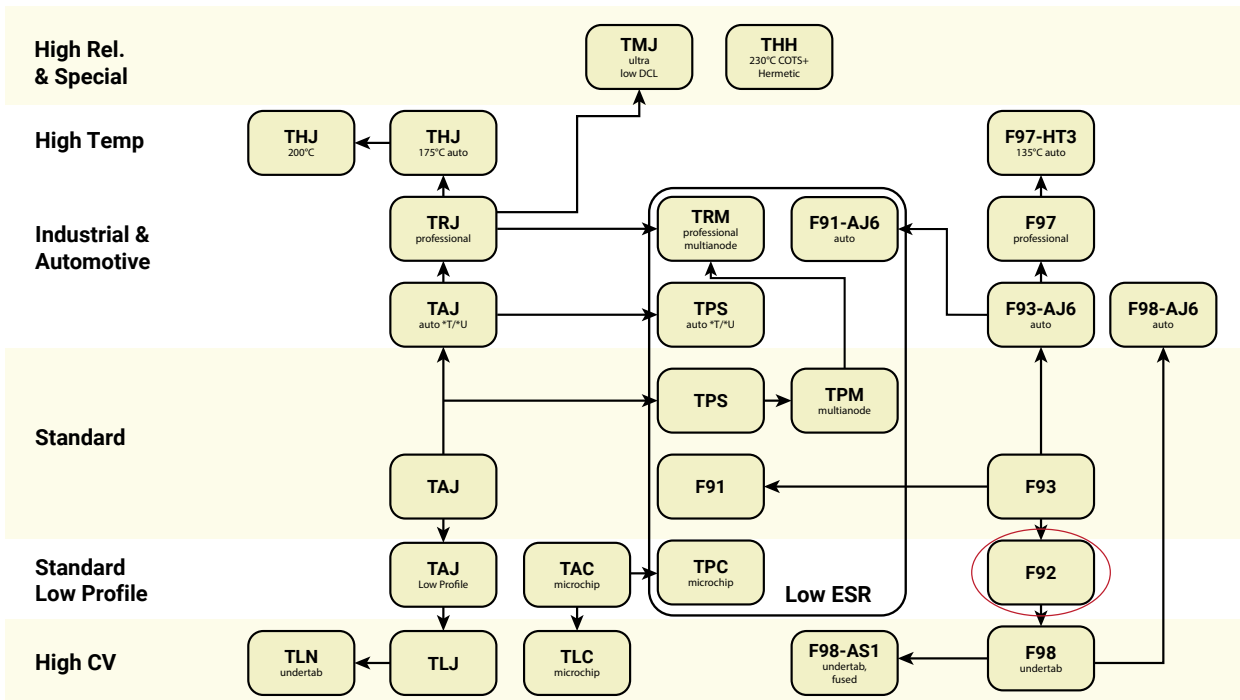

F93 Series

Resin-Molded Chip, Standard Tantalum J-Lead



FEATURES

- Compliant to the RoHS3 directive 2015/863/EU
- SMD J-Lead
- 100% Surge Current Tested

APPLICATIONS

- Low Power DC/DC



CASE DIMENSIONS:

millimeters (inches)

Code	EIA Code	EIA Metric	L	W ₁	W ₂	H	S
A	1206	3216-18	3.20 ± 0.20 (0.126 ± 0.008)	1.60 ± 0.20 (0.063 ± 0.008)	1.20 ± 0.10 (0.047 ± 0.004)	1.60 ± 0.20 (0.063 ± 0.008)	0.80 ± 0.20 (0.031 ± 0.008)
B	1210	3528-21	3.50 ± 0.20 (0.138 ± 0.008)	2.80 ± 0.20 (0.110 ± 0.008)	2.20 ± 0.10 (0.087 ± 0.004)	1.90 ± 0.20 (0.075 ± 0.008)	0.80 ± 0.20 (0.031 ± 0.008)
C	2312	6032-27	6.00 ± 0.20 (0.236 ± 0.008)	3.20 ± 0.20 (0.126 ± 0.008)	2.20 ± 0.10 (0.087 ± 0.004)	2.50 ± 0.20 (0.098 ± 0.008)	1.30 ± 0.20 (0.051 ± 0.008)
N	2917	7343-30	7.30 ± 0.20 (0.287 ± 0.008)	4.30 ± 0.20 (0.169 ± 0.008)	2.40 ± 0.10 (0.094 ± 0.004)	2.80 ± 0.20 (0.110 ± 0.008)	1.30 ± 0.20 (0.051 ± 0.008)

A, B CASE

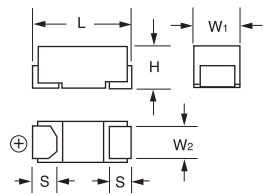

C, N CASE

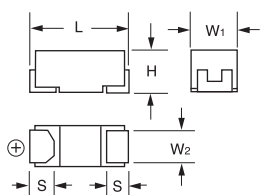

MARKING

A CASE

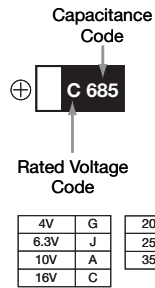

B CASE

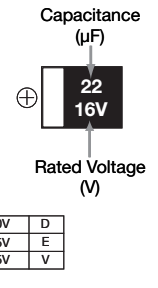

C CASE

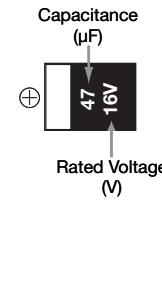

N CASE

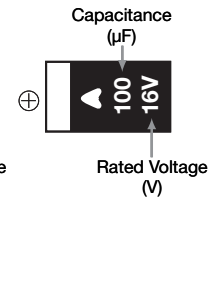

4V	G	20V	D
6.3V	J	25V	E
10V	A	35V	V
16V	C		

HOW TO ORDER

F93

Type

1A

Rated Voltage

106

Capacitance Code
pF code: 1st two digits represent significant figures, 3rd digit represents multiplier (number of zeros to follow)

M

Tolerance
K = ±10%
M = ±20%

A

Case Size
See table above

□

Packaging
See Tape & Reel Packaging Section

TECHNICAL SPECIFICATIONS

Category Temperature Range	-55 to +125°C
Rated Temperature	+85°C
Capacitance Tolerance	±20%, ±10% at 120Hz
Dissipation Factor	Refer to next page
ESR 100kHz	Refer to next page
Leakage Current	After 1 minute's application of rated voltage, leakage current at 20°C is not more than 0.01CV or 0.5μA, whichever is greater. After 1 minute's application of rated voltage, leakage current at 85°C is not more than 0.1CV or 5μA, whichever is greater. After 1 minute's application of derated voltage, leakage current at 125°C is not more than 0.125CV or 6.3μA, whichever is greater.
Capacitance Change By Temperature	+15% Max. at +125°C +10% Max. at +85°C -10% Max. at -55°C

F93 Series

Resin-Molded Chip, Standard Tantalum J-Lead



CAPACITANCE AND RATED VOLTAGE RANGE (LETTER DENOTES CASE SIZE)

Capacitance		Rated Voltage						
µF	Code	4V (0G)	6.3V (0J)	10V (1A)	16V (1C)	20V (1D)	25V (1E)	35V (1V)
0.33	334							A
0.47	474							A
0.68	684							A
1.0	105				A		A	A
1.5	155						A	A
2.2	225				A	A	A	A/B
3.3	335				A	A	A	B
4.7	475			A	A	A/B	A/B	B/C
6.8	685			A	A	A/B		C
10	106		A	A	A/B	B	B/C	C
15	156		A	A	A/B	C	C	N
22	226	A	A	A/B	A/B/C	B/C	C/N	N
33	336	A	A	A/B	B/C	C/N	N	N
47	476	A	A/B	A/B/C	C/N	C/N	N	
68	686	A	B	B/C	C/N			
100	107	A/B	A/B/C	B/C/N	C/N	N		
150	157	B	B/C	C/N	N			
220	227	B/C	B/C/N	C/N	N			
330	337	C	N	N				
470	477	N	N					
680	687	N	N					

Released ratings

Please contact to your local AVX sales office when these series are being designed in your application.

RATINGS & PART NUMBER REFERENCE

AVX Part No.	Case Size	Capacitance (µF)	Rated Voltage (V)	DCL (µA)	DF @ 120Hz (%)	ESR @ 100kHz (Ω)	100kHz RMS Current (mA)			*1 ΔC/C (%)	MSL
							25°C	85°C	125°C		
4 Volt											
F930G226#AA	A	22	4	0.9	6	2.5	173	156	69	*	1
F930G336#AA	A	33	4	1.3	8	2.5	173	156	69	*	1
F930G476#AA	A	47	4	1.9	18	2.5	173	156	69	*	1
F930G686#AA	A	68	4	2.7	24	2.5	173	156	69	*	1
F930G107#AA	A	100	4	4.0	30	2.0	194	174	77	*	1
F930G107#BA	B	100	4	4.0	14	0.9	307	277	123	*	1
F930G157#BA	B	150	4	6.0	16	0.7	348	314	139	*	1
F930G227#BA	B	220	4	8.8	18	0.7	348	314	139	*	1
F930G227#CC	C	220	4	8.8	12	0.7	396	357	159	*	1
F930G337#CC	C	330	4	13.2	14	0.7	396	357	159	*	1
F930G477#NC	N	470	4	18.8	16	0.3	707	636	283	*	1
F930G687#NC	N	680	4	27.2	18	0.3	707	636	283	*	1
6.3 Volt											
F930J106#AA	A	10	6.3	0.6	6	3.0	158	142	63	*	1
F930J156#AA	A	15	6.3	0.9	6	2.9	161	145	64	*	1
F930J226#AA	A	22	6.3	1.4	8	2.5	173	156	69	*	1
F930J336#AA	A	33	6.3	2.1	8	2.5	173	156	69	*	1
F930J476#AA	A	47	6.3	3.0	18	2.5	173	156	69	*	1
F930J476#BA	B	47	6.3	3.0	6	1.0	292	262	117	*	1
F930J686#BA	B	68	6.3	4.3	8	1.0	292	262	117	*	1
F930J107#AA	A	100	6.3	6.3	35	2.0	194	174	77	±15	1
F930J107#BA	B	100	6.3	6.3	14	0.9	307	277	123	*	1
F930J107#CC	C	100	6.3	6.3	8	0.7	396	357	159	*	1
F930J157#BA	B	150	6.3	9.5	18	0.9	307	277	123	*	1
F930J157#CC	C	150	6.3	9.5	12	0.7	396	357	159	*	1
F930J227#BA	B	220	6.3	13.9	30	1.2	266	240	106	±15	3
F930J227#CC	C	220	6.3	13.9	14	0.7	396	357	159	*	1
F930J227#NC	N	220	6.3	13.9	10	0.5	548	493	219	*	1
F930J337#NC	N	330	6.3	20.8	14	0.5	548	493	219	*	1
F930J477#NC	N	470	6.3	29.6	16	0.3	707	636	283	*	1
F930J687#NC	N	680	6.3	42.8	40	0.3	707	636	283	±15	3
10 Volt											
F931A475#AA	A	4.7	10	0.5	6	4.0	137	123	55	*	1
F931A685#AA	A	6.8	10	0.7	6	3.5	146	132	59	*	1
F931A106#AA	A	10	10	1.0	6	3.0	158	142	63	*	1
F931A156#AA	A	15	10	1.5	8	2.9	161	145	64	*	1
F931A226#AA	A	22	10	2.2	12	2.5	173	156	69	*	1



The Important Information/Disclaimer is incorporated in the catalog where these specifications came from or available online at www.avx.com/disclaimer/ by reference and should be reviewed in full before placing any order.

F93 Series

Resin-Molded Chip, Standard Tantalum J-Lead



RATINGS & PART NUMBER REFERENCE

AVX Part No.	Case Size	Capacitance (μF)	Rated Voltage (V)	DCL (μA)	DF @ 120Hz (%)	ESR @ 100kHz (Ω)	100kHz RMS Current (mA)			*1 ΔC/C (%)	MSL
							25°C	85°C	125°C		
F931A226#BA	B	22	10	2.2	6	1.9	212	190	85	*	1
F931A336#AA	A	33	10	3.3	18	2.5	173	156	69	*	1
F931A336#BA	B	33	10	3.3	8	1.4	246	222	99	*	1
F931A476#AA	A	47	10	4.7	40	2.0	194	174	77	±15	1
F931A476#BA	B	47	10	4.7	8	1.0	292	262	117	*	1
F931A476#CC	C	47	10	4.7	6	0.9	350	315	140	*	1
F931A686#BA	B	68	10	6.8	12	0.9	307	277	123	±15	1
F931A686#CC	C	68	10	6.8	8	0.8	371	334	148	*	1
F931A107#BA	B	100	10	10.0	18	1.2	266	240	106	±15	1
F931A107#CC	C	100	10	10.0	10	0.7	396	357	159	*	1
F931A107#NC	N	100	10	10.0	8	0.6	500	450	200	*	3
F931A157#CC	C	150	10	15.0	14	0.7	396	357	159	*	1
F931A157#NC	N	150	10	15.0	10	0.6	500	450	200	*	1
F931A227#CC	C	220	10	22.0	40	0.9	350	315	140	±15	1
F931A227#NC	N	220	10	22.0	12	0.5	548	493	219	*	3
F931A337#NC	N	330	10	33.0	18	0.5	548	493	219	*	1
16 Volt											
F931C105#AA	A	1	16	0.5	4	7.5	100	90	40	*	1
F931C225#AA	A	2.2	16	0.5	4	5.0	122	110	49	*	1
F931C335#AA	A	3.3	16	0.5	4	4.5	129	116	52	*	1
F931C475#AA	A	4.7	16	0.8	6	4.0	137	123	55	*	1
F931C685#AA	A	6.8	16	1.1	6	3.5	146	132	59	*	1
F931C106#AA	A	10	16	1.6	6	3.0	158	142	63	*	1
F931C106#BA	B	10	16	1.6	6	2.0	206	186	82	*	1
F931C156#AA	A	15	16	2.4	10	3.0	158	142	63	*	1
F931C156#BA	B	15	16	2.4	6	2.0	206	186	82	*	1
F931C226#AA	A	22	16	3.5	15	3.0	158	142	63	±15	1
F931C226#BA	B	22	16	3.5	8	1.9	212	190	85	*	1
F931C226#CC	C	22	16	3.5	6	1.1	316	285	126	*	1
F931C336#BA	B	33	16	5.3	8	1.9	212	190	85	*	1
F931C336#CC	C	33	16	5.3	6	1.1	316	285	126	*	1
F931C476#CC	C	47	16	7.5	8	0.9	350	315	140	*	1
F931C476#NC	N	47	16	7.5	6	0.7	463	417	185	*	1
F931C686#CC	C	68	16	10.9	10	0.8	371	334	148	±10	1
F931C686#NC	N	68	16	10.9	6	0.6	500	450	200	*	1
F931C107#CC	C	100	16	16.0	15	0.7	396	357	159	±10	1
F931C107#NC	N	100	16	16.0	10	0.6	500	450	200	*	3
F931C157#NC	N	150	16	24.0	15	0.6	500	450	200	*	1
F931C227#NC	N	220	16	35.2	25	0.7	463	417	185	±10	3
20 Volt											
F931D225#AA	A	2.2	20	0.5	4	5.0	122	110	49	*	1
F931D335#AA	A	3.3	20	0.7	4	4.5	129	116	52	*	1
F931D475#AA	A	4.7	20	0.9	6	3.0	158	142	63	*	1
F931D475#BA	B	4.7	20	0.9	6	2.8	174	157	70	*	1
F931D685#AA	A	6.8	20	1.4	6	3.5	146	132	59	*	1
F931D685#BA	B	6.8	20	1.4	6	2.5	184	166	74	*	1
F931D106#BA	B	10	20	2.0	6	2.1	201	181	80	*	1
F931D156#CC	C	15	20	3.0	6	1.2	303	272	121	*	1
F931D226#BA	B	22	20	4.4	8	1.9	212	190	85	*	1
F931D226#CC	C	22	20	4.4	8	1.1	316	285	126	*	1
F931D336#CC	C	33	20	6.6	8	1.1	316	285	126	*	1
F931D336#NC	N	33	20	6.6	6	0.7	463	417	185	*	1
F931D476#CC	C	47	20	9.4	10	1.1	316	285	126	*	1
F931D476#NC	N	47	20	9.4	8	0.7	463	417	185	*	1
F931D107#NC	N	100	20	20.0	12	0.5	548	493	219	±10	3
25 Volt											
F931E105#AA	A	1	25	0.5	4	7.5	100	90	40	*	1
F931E155#AA	A	1.5	25	0.5	4	6.7	106	95	42	*	1
F931E225#AA	A	2.2	25	0.6	6	6.3	109	98	44	*	1
F931E335#AA	A	3.3	25	0.8	6	6.0	112	101	45	*	1
F931E475#AA	A	4.7	25	1.2	8	4.0	137	123	55	*	1
F931E475#BA	B	4.7	25	1.2	6	2.8	174	157	70	*	1
F931E106#BA	B	10	25	2.5	12	1.9	212	190	85	*	1
F931E106#CC	C	10	25	2.5	6	1.5	271	244	108	*	1
F931E156#CC	C	15	25	3.8	8	1.2	303	272	121	*	1
F931E226#CC	C	22	25	5.5	8	1.1	316	285	126	*	1
F931E226#NC	N	22	25	5.5	6	0.7	463	417	185	*	1
F931E336#NC	N	33	25	8.3	8	0.7	463	417	185	*	1
F931E476#NC	N	47	25	11.8	8	0.7	463	417	185	*	1
F931E226#NC	N	22	25	5.5	6	0.7	463	417	185	*	1
F931E336#NC	N	33	25	8.3	8	0.7	463	417	185	*	1
F931E476#NC	N	47	25	11.8	8	0.7	463	417	185	*	1

F93 Series

Resin-Molded Chip, Standard Tantalum J-Lead

RATINGS & PART NUMBER REFERENCE

AVX Part No.	Case Size	Capacitance (μF)	Rated Voltage (V)	DCL (μA)	DF @ 120Hz (%)	ESR @ 100kHz (Ω)	100kHz RMS Current (mA)			*1 ΔC/C (%)	MSL
							25°C	85°C	125°C		
35 Volt											
F931V334#AA	A	0.33	35	0.5	4	12.0	79	71	32	*	1
F931V474#AA	A	0.47	35	0.5	4	10.0	87	78	35	*	1
F931V684#AA	A	0.68	35	0.5	4	7.6	99	89	40	*	1
F931V105#AA	A	1	35	0.5	4	7.5	100	90	40	*	1
F931V155#AA	A	1.5	35	0.5	6	7.5	100	90	40	*	1
F931V225#AA	A	2.2	35	0.8	6	7.0	104	93	41	*	1
F931V225#BA	B	2.2	35	0.8	4	3.8	150	135	60	*	1
F931V335#BA	B	3.3	35	1.2	4	3.5	156	140	62	*	1
F931V475#BA	B	4.7	35	1.6	8	3.1	166	149	66	*	1
F931V475#CC	C	4.7	35	1.6	6	1.8	247	222	99	*	1
F931V685#CC	C	6.8	35	2.4	6	1.8	247	222	99	*	1
F931V106#CC	C	10	35	3.5	6	1.6	262	236	105	*	1
F931V156#NC	N	15	35	5.3	6	0.7	463	417	185	*	1
F931V226#NC	N	22	35	7.7	8	0.7	463	417	185	*	1
F931V336#NC	N	33	35	11.6	8	0.7	463	417	185	*	1

*1: ΔC/C Marked "**"

#: "M" for ±20% tolerance, "K" for ±10% tolerance.
Moisture Sensitivity Level (MSL) is defined according to J-STD-020.

Item	All Case (%)
Damp Heat	±10
Temperature cycles	±5
Resistance soldering heat	±5
Surge	±5
Endurance	±10

QUALIFICATION TABLE

TEST	F93 series (Temperature range -55°C to +125°C)	
	Condition	
Damp Heat (Steady State)	At 40°C, 90 to 95% R.H., 500 hours (No voltage applied) Capacitance Change Refer to page 33 (*1) Dissipation Factor Initial specified value or less Leakage Current Initial specified value or less	
Temperature Cycles	-55°C / +125°C, 30 minutes each, 5 cycles Capacitance Change Refer to page 33 (*1) Dissipation Factor Initial specified value or less Leakage Current Initial specified value or less	
Resistance to Soldering Heat	10 seconds reflow at 260°C, 5 seconds immersion at 260°C. Capacitance Change Refer to page 33 (*1) Dissipation Factor Initial specified value or less Leakage Current Initial specified value or less	
Surge	After application of surge voltage in series with a 33Ω resistor at the rate of 30 seconds ON, 30 seconds OFF, for 1000 successive test cycles at 85°C, capacitors shall meet the characteristic requirements in the table above. Capacitance Change Refer to page 33 (*1) Dissipation Factor Initial specified value or less Leakage Current Initial specified value or less	
Endurance	After 2000 hours' application of rated voltage in series with a 30Ω resistor at 85°C, or derated voltage in series with a 30Ω resistor at 125°C, capacitors shall meet the characteristic requirements in the table above. Capacitance Change Refer to page 33 (*1) Dissipation Factor Initial specified value or less Leakage Current Initial specified value or less	
Shear Test	After applying the pressure load of 5N for 10±1 seconds horizontally to the center of capacitor side body which has no electrode and has been soldered beforehand on a substrate, there shall be found neither exfoliation nor its sign at the terminal electrode.	
Terminal Strength	Keeping a capacitor surface-mounted on a substrate upside down and supporting the substrate at both of the opposite bottom points 45mm apart from the center of capacitor, the pressure strength is applied with a specified jig at the center of substrate so that the substrate may bend by 1mm as illustrated. Then, there shall be found no remarkable abnormality on the capacitor terminals.	
Failure Rate	1% per 1000 hours at 85°C, V _R with 0.1Ω/V series impedance, 60% confidence level.	

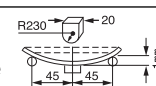
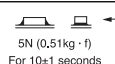

We can supply the type of compliance to AEC-Q200. Please contact to your local AVX sales office when these series are being designed in your application.

F93 Series

Resin-Molded Chip, Standard Tantalum J-Lead



AVX SOLID ELECTROLYTIC CAPACITOR ROADMAP

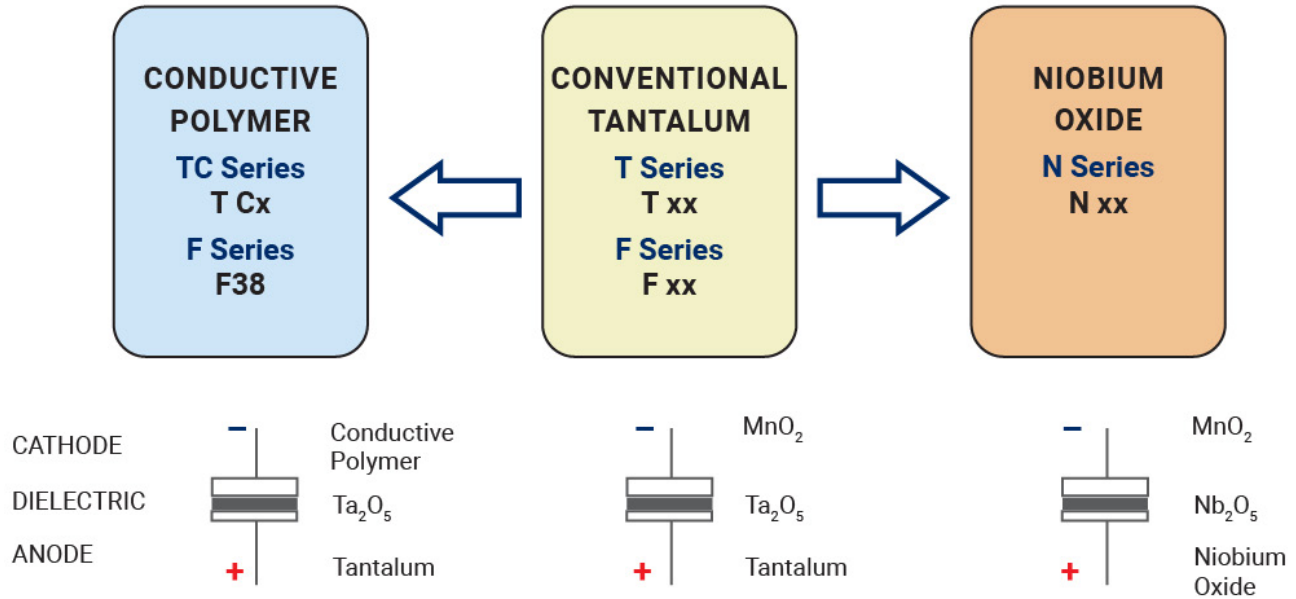

FIVE CAPACITOR CONSTRUCTION STYLES

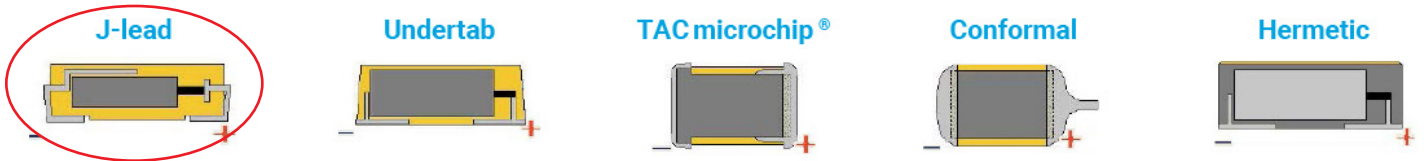

SERIES LINE UP: CONVENTIONAL SMD MnO₂

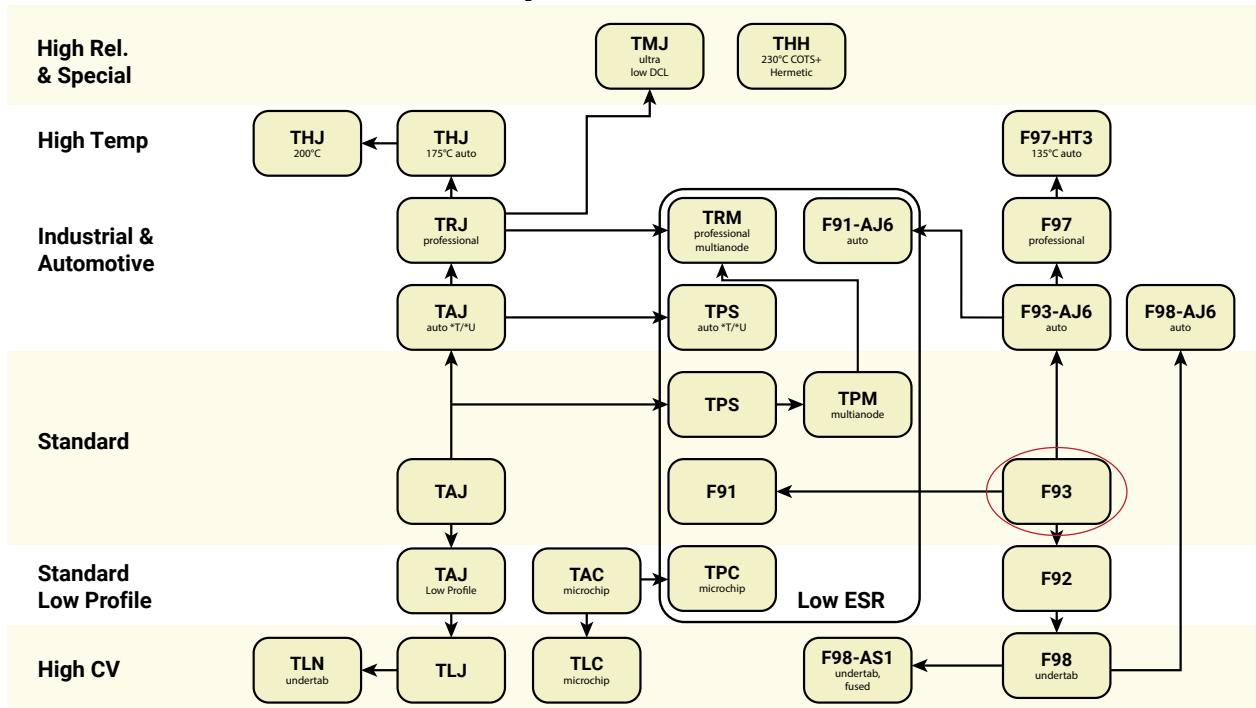

F93-AJ6 Series

Resin-Molded Chip - Automotive Product Range

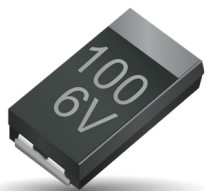

FEATURES

- Compliant to the RoHS3 directive 2015/863/EU
- Compliant to AEC-Q200
- 100% Surge Current Tested

APPLICATIONS

- Cabin Electronics
- Infotainment



CASE DIMENSIONS:

millimeters (inches)

Code	EIA Code	EIA Metric	L	W ₁	W ₂	H	S
A	1206	3216-18	3.20 ± 0.20 (0.126 ± 0.008)	1.60 ± 0.20 (0.063 ± 0.008)	1.20 ± 0.10 (0.047 ± 0.004)	1.60 ± 0.20 (0.063 ± 0.008)	0.80 ± 0.20 (0.031 ± 0.008)
B	1210	3528-21	3.50 ± 0.20 (0.138 ± 0.008)	2.80 ± 0.20 (0.110 ± 0.008)	2.20 ± 0.10 (0.087 ± 0.004)	1.90 ± 0.20 (0.075 ± 0.008)	0.80 ± 0.20 (0.031 ± 0.008)
C	2312	6032-27	6.00 ± 0.20 (0.236 ± 0.008)	3.20 ± 0.20 (0.126 ± 0.008)	2.20 ± 0.10 (0.087 ± 0.004)	2.50 ± 0.20 (0.098 ± 0.008)	1.30 ± 0.20 (0.051 ± 0.008)
N	2917	7343-30	7.30 ± 0.20 (0.287 ± 0.008)	4.30 ± 0.20 (0.169 ± 0.008)	2.40 ± 0.10 (0.094 ± 0.004)	2.80 ± 0.20 (0.110 ± 0.008)	1.30 ± 0.20 (0.051 ± 0.008)

A, B CASE

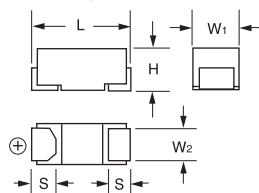

C, N CASE

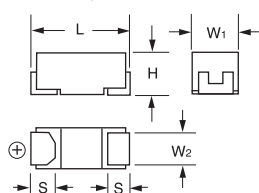

MARKING

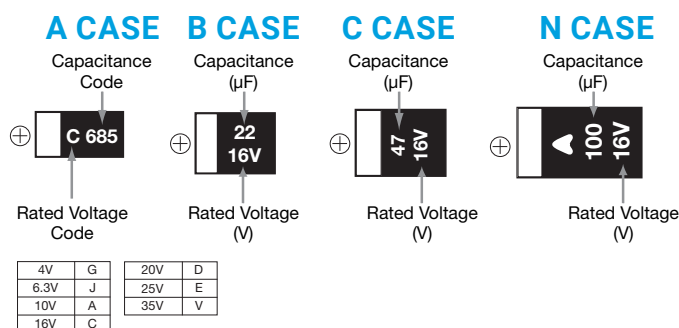

HOW TO ORDER

F93
Type

1A
Rated Voltage

106
Capacitance Code
pF code: 1st two digits represent significant figures, 3rd digit represents multiplier(number of zeros to follow)

M
Tolerance
K = ±10%
M = ±20%

A
Case Size
See table above

□
Packaging
See Tape & Reel Packaging Section

AJ6
AEC-Q200 Compliant

TECHNICAL SPECIFICATIONS

Category Temperature Range	-55 to +125°C
Rated Temperature	+85°C
Capacitance Tolerance	±20%, ±10% at 120Hz
Dissipation Factor	Refer to next page
ESR 100kHz	Refer to next page
Leakage Current	After 1 minute's application of rated voltage, leakage current at 20°C is not more than 0.01CV or 0µA, whichever is greater. After 1 minute's application of rated voltage, leakage current at 85°C is not more than 0.1CV or 5µA, whichever is greater. After 1 minute's application of derated voltage, leakage current at 125°C is not more than 0.125CV or 6µA, whichever is greater.
Capacitance Change By Temperature	+15% Max. at +125°C +10% Max. at +85°C -10% Max. at -55°C

F93-AJ6 Series

Resin-Molded Chip - Automotive Product Range



CAPACITANCE AND RATED VOLTAGE RANGE (LETTER DENOTES CASE SIZE)

Capacitance		Rated Voltage						
μF	Code	4V (0G)	6.3V (0J)	10V (1A)	16V (1C)	20V (1D)	25V (1E)	35 V (1V)
1.0	105				A		A	A
1.5	155						A	A
2.2	225				A	A	A	B
3.3	335				A	A		B
4.7	475			A	A	A/B	A/B	B/C
6.8	685			A	A	A/B		C
10	106		A	A	A/B	A/B	C	C
15	156		A	A	A/B	C	C	N
22	226	A	A	A/B	B/C	B/C	C/N	N
33	336	A	A	B	B/C	C/N	N	N
47	476	A	A/B	B/C	C/N	C/N	N	
68	686	A	B	B/C	C/N			
100	107	A/B	B/C	C/N	C/N			
150	157	B	C	N				
220	227	B/C	C/N	N				
330	337	C	N					
470	477	N	N					
680	687	N	N					

Released ratings (M tolerance only)

RATINGS & PART NUMBER REFERENCE

AVX Part No.	Case Size	Capacitance (μF)	Rated Voltage (V)	DCL (μA)	DF @ 120Hz (%)	ESR @ 100kHz (Ω)	100kHz RMS Current (mA)			*1 ΔC/C (%)	MSL
							25°C	85°C	125°C		
4 Volt											
F930G226#AAAJ6	A	22	4	0.9	6	2.5	173	156	69	*	3
F930G336#AAAJ6	A	33	4	1.3	8	2.5	173	156	69	*	3
F930G476#AAAJ6	A	47	4	1.9	18	2.5	173	156	69	*	3
F930G686#AAAJ6	A	68	4	2.7	24	2.5	173	156	69	*	3
F930G107#AAAJ6	A	100	4	4	30	2.0	194	174	77	*	3
F930G107#BAAJ6	B	100	4	4	14	0.9	307	277	123	*	3
F930G157#BAAJ6	B	150	4	6	16	0.7	348	314	139	*	3
F930G227#BAAJ6	B	220	4	8.8	18	0.7	348	314	139	*	3
F930G227#CCAJ6	C	220	4	8.8	12	0.7	396	357	159	*	3
F930G337#CCAJ6	C	330	4	13.2	14	0.7	396	357	159	*	3
F930G477#NCAJ6	N	470	4	18.8	16	0.3	707	636	283	*	3
F930G687#NCAJ6	N	680	4	27.2	18	0.3	707	636	283	*	3
6.3 Volt											
F930J106#AAAJ6	A	10	6.3	0.6	6	3.0	158	142	63	*	3
F930J156#AAAJ6	A	15	6.3	0.9	6	2.9	161	145	64	*	3
F930J226#AAAJ6	A	22	6.3	1.4	8	2.5	173	156	69	*	3
F930J336#AAAJ6	A	33	6.3	2.1	8	2.5	173	156	69	*	3
F930J476#AAAJ6	A	47	6.3	3	18	2.5	173	156	69	*	3
F930J476#BAAJ6	B	47	6.3	3	6	1.0	292	262	117	*	3
F930J686#BAAJ6	B	68	6.3	4.3	8	1.0	292	262	117	*	3
F930J107#BAAJ6	B	100	6.3	6.3	14	0.9	307	277	123	*	3
F930J107#CCAJ6	C	100	6.3	6.3	8	0.7	396	357	159	*	3
F930J157#CCAJ6	C	150	6.3	9.5	12	0.7	396	357	159	*	3
F930J227#CCAJ6	C	220	6.3	13.9	14	0.7	396	357	159	*	3
F930J227#NCAJ6	N	220	6.3	13.9	10	0.5	548	493	219	*	3
F930J337#NCAJ6	N	330	6.3	20.8	14	0.5	548	493	219	*	3
F930J477#NCAJ6	N	470	6.3	29.6	16	0.3	707	636	283	*	3
F930J687#NCAJ6	N	680	6.3	42.8	40	0.3	707	636	283	±15	3
10 Volt											
F931A475#AAAJ6	A	4.7	10	0.5	6	4.0	137	123	55	*	3
F931A685#AAAJ6	A	6.8	10	0.7	6	3.5	146	132	59	*	3
F931A106#AAAJ6	A	10	10	1	6	3.0	158	142	63	*	3
F931A156#AAAJ6	A	15	10	1.5	8	2.9	161	145	64	*	3
F931A226#AAAJ6	A	22	10	2.2	12	2.5	173	156	69	*	3
F931A226#BAAJ6	B	22	10	2.2	6	1.9	212	190	85	*	3
F931A336#BAAJ6	B	33	10	3.3	8	1.4	246	222	99	*	3
F931A476#BAAJ6	B	47	10	4.7	8	1.0	292	262	117	*	3
F931A476#CCAJ6	C	47	10	4.7	6	0.9	350	315	140	*	3
F931A686#BAAJ6	B	68	10	6.8	12	0.9	307	277	123	±15	3
F931A686#CCAJ6	C	68	10	6.8	8	0.8	371	334	148	*	3
F931A107#CCAJ6	C	100	10	10	10	0.7	396	357	159	*	3
F931A107#NCAJ6	N	100	10	10	8	0.6	500	450	200	*	3
F931A157#NCAJ6	N	150	10	15	10	0.6	500	450	200	*	3
F931A227#NCAJ6	N	220	10	22	12	0.5	548	493	219	*	3

*1: ΔC/C Marked "**"

*#: "M" for ±20% tolerance, "K" for ±10% tolerance. When you need K tolerance for the part numbers which have M tolerance only, please contact to your local AVX sales office.

Moisture Sensitivity Level (MSL) is defined according to J-STD-020.



F93-AJ6 Series

Resin-Molded Chip - Automotive Product Range



RATINGS & PART NUMBER REFERENCE

AVX Part No.	Case Size	Capacitance (µF)	Rated Voltage (V)	DCL (µA)	DF @ 120Hz (%)	ESR @ 100kHz (Ω)	100kHz RMS Current (mA)			*1 ΔC/C (%)	MSL
							25°C	85°C	125°C		
16 Volt											
F931C105#AAAJ6	A	1	16	0.5	4	7.5	100	90	40	*	3
F931C225#AAAJ6	A	2.2	16	0.5	4	5.0	122	110	49	*	3
F931C335#AAAJ6	A	3.3	16	0.5	4	4.5	129	116	52	*	3
F931C475#AAAJ6	A	4.7	16	0.8	6	4.0	137	123	55	*	3
F931C685#AAAJ6	A	6.8	16	1.1	6	3.5	146	132	59	*	3
F931C106#AAAJ6	A	10	16	1.6	6	3.0	158	142	63	*	3
F931C106#BAAJ6	B	10	16	1.6	6	2.0	206	186	82	*	3
F931C156#AAAJ6	A	15	16	2.4	10	3.0	158	142	63	*	3
F931C156#BAAJ6	B	15	16	2.4	6	2.0	206	186	82	*	3
F931C226#BAAJ6	B	22	16	3.5	8	1.9	212	190	85	*	3
F931C226#CCAJ6	C	22	16	3.5	6	1.1	316	285	126	*	3
F931C336#BAAJ6	B	33	16	5.3	8	1.9	212	190	85	*	3
F931C336#CCAJ6	C	33	16	5.3	6	1.1	316	285	126	*	3
F931C476#CCAJ6	C	47	16	7.5	8	0.9	350	315	140	*	3
F931C476#NCAJ6	N	47	16	7.5	6	0.7	463	417	185	*	3
F931C686#CCAJ6	C	68	16	10.9	10	0.8	371	334	148	*	3
F931C686#NCAJ6	N	68	16	10.9	6	0.6	500	450	200	*	3
F931C107#CCAJ6	C	100	16	16	15	0.7	396	357	159	*	3
F931C107#NCAJ6	N	100	16	16	10	0.6	500	450	200	*	3
20 Volt											
F931D225#AAAJ6	A	2.2	20	0.5	4	5.0	122	110	49	*	3
F931D335#AAAJ6	A	3.3	20	0.7	4	4.5	129	116	52	*	3
F931D475#AAAJ6	A	4.7	20	0.9	6	3.0	158	142	63	*	3
F931D475#BAAJ6	B	4.7	20	0.9	6	2.8	174	157	70	*	3
F931D685#AAAJ6	A	6.8	20	1.4	6	3.5	146	132	59	*	3
F931D685#BAAJ6	B	6.8	20	1.4	6	2.5	184	166	74	*	3
F931D106#AAAJ6	A	10	20	2	8	3.5	146	132	59	*	3
F931D106#BAAJ6	B	10	20	2	6	2.1	201	181	80	*	3
F931D156#CCAJ6	C	15	20	3	6	1.2	303	272	121	*	3
F931D226#BAAJ6	B	22	20	4.4	8	1.9	212	190	85	*	3
F931D226#CCAJ6	C	22	20	4.4	8	1.1	316	285	126	*	3
F931D336#CCAJ6	C	33	20	6.6	8	1.1	316	285	126	*	3
F931D336#NCAJ6	N	33	20	6.6	6	0.7	463	417	185	*	3
F931D476#CCAJ6	C	47	20	9.4	10	1.1	316	285	126	*	3
F931D476#NCAJ6	N	47	20	9.4	8	0.7	463	417	185	*	3
25 Volt											
F931E105#AAAJ6	A	1	25	0.5	4	7.5	100	90	40	*	3
F931E155#AAAJ6	A	1.5	25	0.5	4	6.7	106	95	42	*	3
F931E225#AAAJ6	A	2.2	25	0.6	6	6.3	109	98	44	*	3
F931E475#AAAJ6	A	4.7	25	1.2	8	4.0	137	123	55	*	3
F931E475#BAAJ6	B	4.7	25	1.2	6	2.8	174	157	70	*	3
F931E106#CCAJ6	C	10	25	2.5	6	1.5	271	244	108	*	3
F931E156#CCAJ6	C	15	25	3.8	8	1.2	303	272	121	*	3
F931E226#CCAJ6	C	22	25	5.5	8	1.1	316	285	126	*	3
F931E226#NCAJ6	N	22	25	5.5	6	0.7	463	417	185	*	3
F931E336#NCAJ6	N	33	25	8.3	8	0.7	463	417	185	*	3
F931E476#NCAJ6	N	47	25	11.8	8	0.7	463	417	185	*	3
35 Volt											
F931V105#AAAJ6	A	1	35	0.5	4	7.5	100	90	40	*	3
F931V155#AAAJ6	A	1.5	35	0.5	6	7.5	100	90	40	*	3
F931V225#BAAJ6	B	2.2	35	0.8	4	3.8	150	135	60	*	3
F931V335#BAAJ6	B	3.3	35	1.2	4	3.5	156	140	62	*	3
F931V475#BAAJ6	B	4.7	35	1.6	8	3.1	166	149	66	*	3
F931V475#CCAJ6	C	4.7	35	1.6	6	1.8	247	222	99	*	3
F931V685#CCAJ6	C	6.8	35	2.4	6	1.8	247	222	99	*	3
F931V106#CCAJ6	C	10	35	3.5	6	1.6	262	236	105	*	3
F931V156#NCAJ6	N	15	35	5.3	6	0.7	463	417	185	*	3
F931V226#NCAJ6	N	22	35	7.7	8	0.7	463	417	185	*	3
F931V336#NCAJ6	N	33	35	11.6	8	0.7	463	417	185	*	3

*1: ΔC/C Marked "**"

*#: "M" for ±20% tolerance, "K" for ±10% tolerance. When you need K tolerance for the part numbers which have M tolerance only, please contact to your local AVX sales office. Moisture Sensitivity Level (MSL) is defined according to J-STD-020.

Item	All Case (%)
Damp Heat	±10
Temperature cycles	±10
Resistance soldering heat	±10
Surge	±10
Endurance	±10
Load Humidity	±10



The Important Information/Disclaimer is incorporated in the catalog where these specifications came from or available online at www.avx.com/disclaimer/ by reference and should be reviewed in full before placing any order.

F93-AJ6 Series

Resin-Molded Chip - Automotive Product Range

QUALIFICATION TABLE

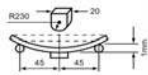
TEST	F92 series (Temperature range -55°C to +125°C)	
	Condition	
Damp Heat (Steady State)	At 40°C, 90 to 95% R.H., 500 hours (No voltage applied) Capacitance Change Refer to page 42 (*1) Dissipation Factor Initial specified value or less Leakage Current Initial specified value or less	
Load Humidity	After 1000 hour's application of rated voltage in series with a 33Ω resistor at 85°C, 85% R.H., capacitors meet the characteristics requirements table below. Capacitance Change Refer to page 42 (*1) Dissipation Factor Initial specified value or less Leakage Current 125% or less than the initial specified value	
Temperature Cycles	At -55°C / +125°C, 30 minutes each, 1000 cycles Capacitance Change Refer to page 42 (*1) Dissipation Factor Initial specified value or less Leakage Current Initial specified value or less	
Resistance to Soldering Heat	10 seconds reflow at 260°C, 10 seconds immersion at 260°C. Capacitance Change Refer to page 42 (*1) Dissipation Factor Initial specified value or less Leakage Current Initial specified value or less	
Surge	After application of surge voltage in series with a 33Ω resistor at the rate of 30 seconds ON, 30 seconds OFF, for 1000 successive test cycles at 85°C, capacitors shall meet the characteristic requirements in the table above. Capacitance Change Refer to page 42 (*1) Dissipation Factor Initial specified value or less Leakage Current Initial specified value or less	
Endurance	After 2000 hours' application of rated voltage in series with a 3Ω resistor at 85°C, or derated voltage in series with a 3Ω resistor at 125°C, capacitors shall meet the characteristic requirements in the table above. Capacitance Change Refer to page 42 (*1) Dissipation Factor Initial specified value or less Leakage Current Initial specified value or less	
Shear Test	After applying the pressure load of 17.7N for 60 seconds horizontally to the center of capacitor side body which has no electrode and has been soldered beforehand on a substrate, there shall be found neither exfoliation nor its sign at the terminal electrode.	
Terminal Strength	Keeping a capacitor surface-mounted on a substrate upside down and supporting the substrate at both of the opposite bottom points 45mm apart from the center of capacitor, the pressure strength is applied with a specified jig at the center of the substrate so that substrate may bend by 1mm as illustrated. Then, there shall be found no remarkable abnormality on the capacitor terminals.	
Failure Rate	1% per 1000 hours at 85°C, V _R with 0.1Ω/V series impedance, 60% confidence level.	

F93-AJ6 Series

Resin-Molded Chip - Automotive Product Range

AVX SOLID ELECTROLYTIC CAPACITOR ROADMAP

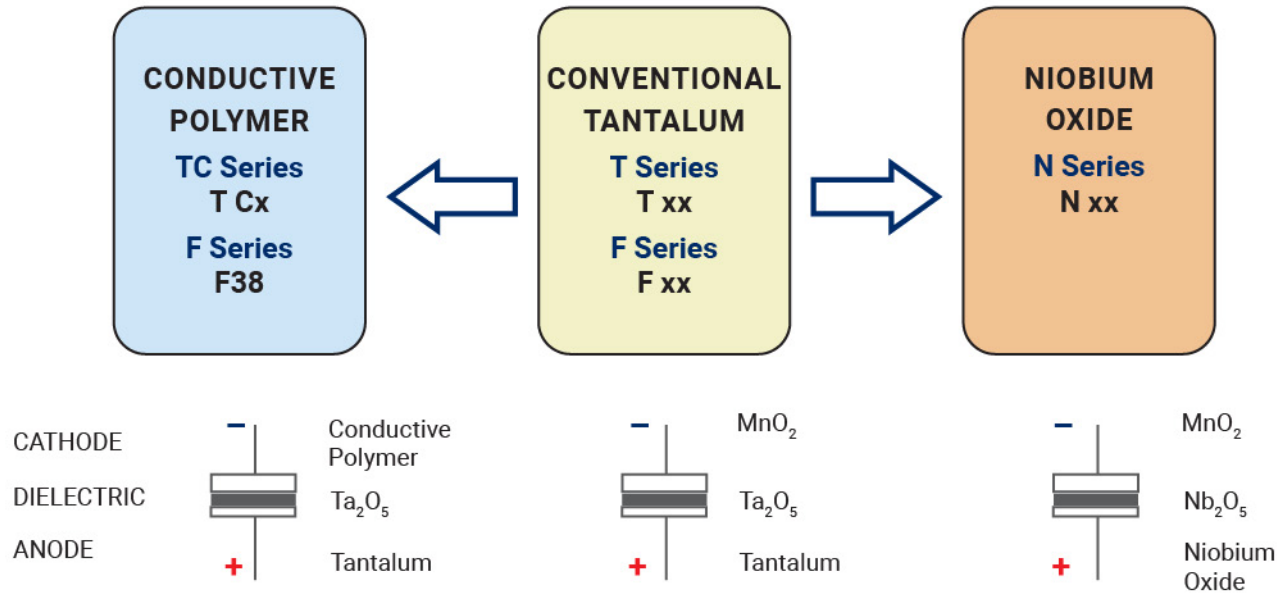

FIVE CAPACITOR CONSTRUCTION STYLES

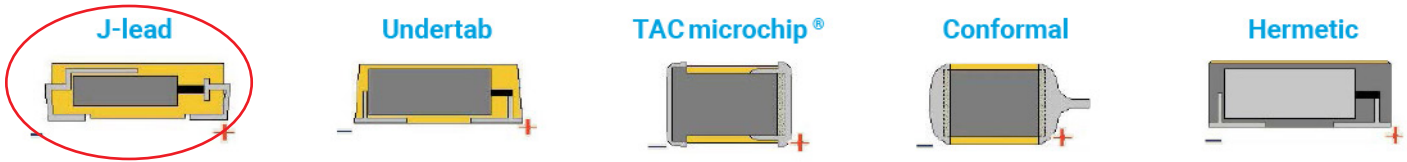

SERIES LINE UP: CONVENTIONAL SMD MnO2

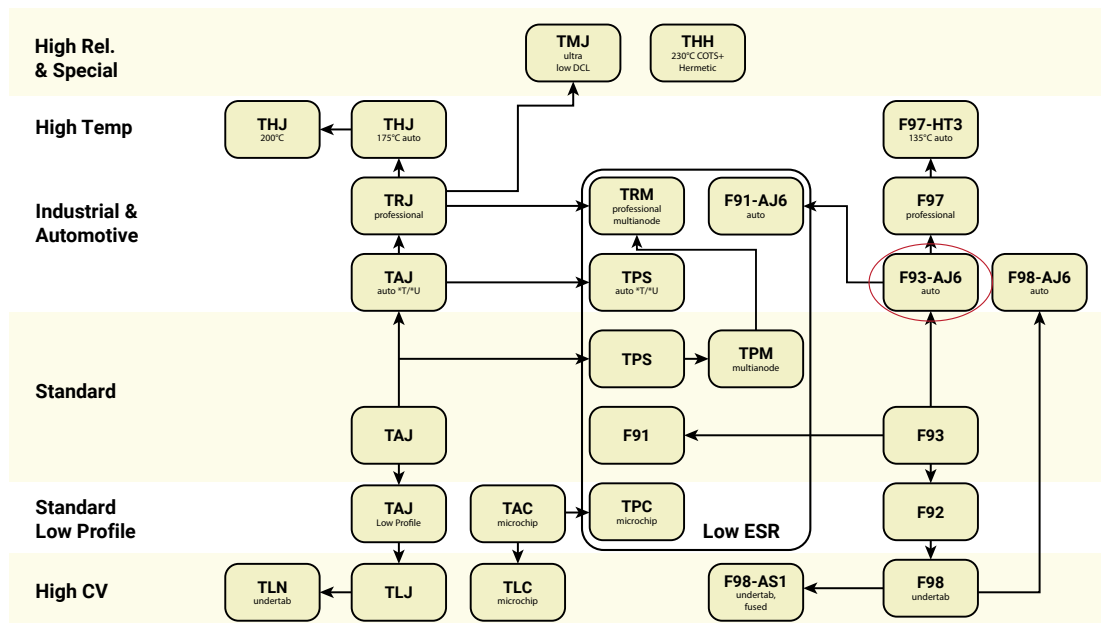

TLJ Series

Tantalum Solid Electrolytic Chip Capacitors - High CV Consumer Series

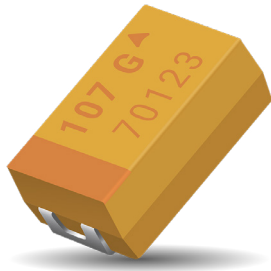

FEATURES

- High Volumetric Efficiency
- 3x Reflow 260°C Compatible
- 100% Surge Current Tested
- 14 Case Sizes Available Including Low Profile Codes
- Environmentally Friendly
- Consumer Applications (e.g. Mobiles Phones, PDA etc.)
- CV Range: 10-1500µF / 2.5-20V



LEAD-FREE COMPATIBLE COMPONENT

APPLICATIONS

- Mobile Phones
- MP3/4 Players

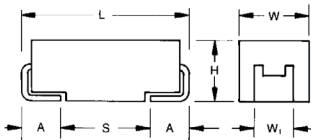

MARKING

A, B, F, G, H, K, S, T, V, W, Y CASE

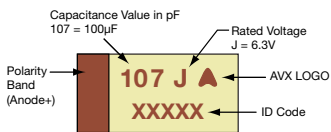

N, P, R CASE

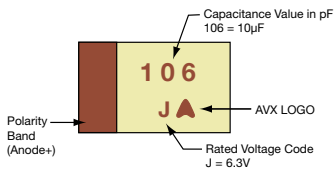

STANDARD CASE DIMENSIONS:

millimeters (inches)

Code	EIA Code	EIA Metric	L±0.20 (0.008)	W+0.20 (0.008) -0.10 (0.004)	H+0.20 (0.008) -0.10 (0.004)	W ₁ ±0.20 (0.008)	A+0.30 (0.012) -0.20 (0.008)	S Min.
A	1206	3216-18	3.20 (0.126)	1.60 (0.063)	1.60 (0.063)	1.20 (0.047)	0.80 (0.031)	1.10 (0.043)
B	1210	3528-21	3.50 (0.138)	2.80 (0.110)	1.90 (0.075)	2.20 (0.087)	0.80 (0.031)	1.40 (0.055)
F	2312	6032-20	6.00 (0.236)	3.20 (0.126)	2.00 (0.079) max.	2.20 (0.087)	1.30 (0.051)	2.90 (0.114)
G	1206	3216-15	3.20 (0.126)	1.60 (0.063)	1.50 (0.059) max	1.20 (0.047)	0.80 (0.031)	1.10 (0.043)
H	1210	3528-15	3.50 (0.138)	2.80 (0.110)	1.50 (0.059) max	2.20 (0.087)	0.80 (0.031)	1.40 (0.055)
K	1206	3216-10	3.20 (0.126)	1.60 (0.063)	1.00 (0.039) max	1.20 (0.047)	0.80 (0.031)	1.10 (0.043)
N	0805	2012-10	2.05 (0.081)	1.30 (0.051)	1.00 (0.039) max	1.00 (0.039)	0.50 (0.020)	0.85 (0.033)
P	0805	2012-15	2.05 (0.081)	1.35 (0.053)	1.50 (0.059) max	1.00±0.10 (0.039±0.004)	0.50 (0.020)	0.85 (0.033)
R	0805	2012-12	2.05 (0.081)	1.30 (0.051)	1.20 (0.047) max	1.20 (0.047)	0.50 (0.020)	0.85 (0.033)
S	1206	3216-12	3.20 (0.126)	1.60 (0.063)	1.20 (0.047) max	1.20 (0.047)	0.80 (0.031)	1.10 (0.043)
T	1210	3528-12	3.50 (0.138)	2.80 (0.110)	1.20 (0.047) max	2.20 (0.087)	0.80 (0.031)	1.40 (0.033)
V	2924	7361-38	7.30 (0.287)	6.10 (0.240)	3.55 (0.140)	3.10 (0.122)	1.30 (0.051)	4.40 (0.173)
W	2312	6032-15	6.00 (0.236)	3.20 (0.126)	1.50 (0.059) max	2.20 (0.087)	1.30 (0.051)	2.90 (0.114)
Y	2917	7343-20	7.30 (0.287)	4.30 (0.169)	2.00 (0.079) max	2.40 (0.094)	1.30 (0.051)	4.40 (0.173)

W₁ dimension applies to the termination width for A dimensional area only.

HOW TO ORDER

TLJ
Type

W
Case Size
See table above

157
Capacitance Code
pF code: 1st two digits represent significant figures, 3rd digit represents multiplier (number of zeros to follow)

M
Tolerance
M = ±20%

010
Rated DC Voltage
002 = 2.5Vdc
004 = 4Vdc
006 = 6.3Vdc
010 = 10Vdc
016 = 16Vdc
020 = 20Vdc

R
Packaging
R = Pure Tin 7" Reel
S = Pure Tin 13" Reel

0200
ESR in mΩ

TECHNICAL SPECIFICATIONS

Technical Data:	All technical data relate to an ambient temperature of +25°C							
Capacitance Range:	10 µF to 1500 µF							
Capacitance Tolerance:	±20%							
Rated Voltage (V _R)	-55°C ≤ +40°C:	2.5	4	6.3	10	16	20	
Category Voltage (V _C)	at 85°C:	1.3	2	3.2	5	8	10	
Category Voltage (V _C)	at 125°C:	0.5	0.8	1.3	2	3.2	4	
Temperature Range:	-55°C to +125°C with category voltage							
Reliability:	0.2% per 1000 hours at 85°C, 0.5xV _R with 0.1Ω/V series impedance with 60% confidence level							

TLJ Series

Tantalum Solid Electrolytic Chip Capacitors - High CV Consumer Series



CAPACITANCE AND RATED VOLTAGE RANGE (LETTER DENOTES CASE SIZE)

Capacitance		Rated Voltage DC to 40°C / 0.5DC to 85°C / 0.2DC to 125°C					
µF	Code	2.5V (e)	4V (G)	6.3V (J)	10V (A)	16V (C)	20V (D)
6.8	685						
10	106				N(2500) R(2000,3000)	S(2200)	T(1000)
15	156				R(2000)		
22	226			N(5400)/R(3500)	K(1800)/N(3800) R(3800)	T(1000)	
33	336		N(8000) R(3000)	K(1700)/N(8000) P(3000)/R(3000)	K(1500)/N(9600) P(3500)/R(3500) S(1500)	T(1000)	
47	476		K(1500)/N(4000) P(3000)/R(3000)	K(1500)/N(8300) P(700,900,1800,2500) R(3200)/S(1500)	A(600)/G(1500) P(3200)/R(3200) S(1500)/T(600)		
68	686		K(1200)/N(8000) P(3000)/R(2900) S(1500)	A(500)/G(800) K(2000)/S(1500) T(600)	A(1500)		
100	107		A(500)/G(800) K(2000)/P(2700) S(1400)	A(500,800)/G(800) K(2000)/(5400)/T(800)	A(1400)/H(900) T(900)		
150	157		A(800)/T(800)	A(900)/H(900) T(1200)	B(500)/W(150,200)		
220	227	T(1100)	A(1100)/G(3000) H(900)/T(1100)	B(500)/T(2000) W(200)	F(300)		
330	337		T(2700)/W(200)	F(300)			
470	477						
680	687			Y(100,150)			
1000	108						
1500	158			V(100)			

Released ratings, (ESR ratings in mOhms in parentheses)

Note: Voltage ratings are minimum values. AVX reserves the right to supply higher voltage ratings in the same case size, to the same reliability standards.

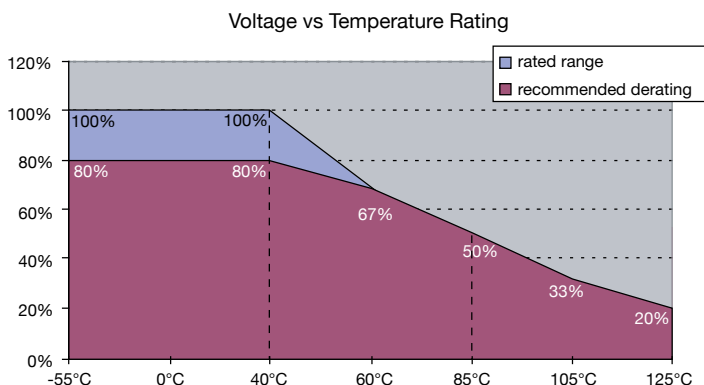

TLJ Series

Tantalum Solid Electrolytic Chip Capacitors - High CV Consumer Series



RATINGS & PART NUMBER REFERENCE

AVX Part No.	Case Size	Capacitance (µF)	Rated Voltage (V)	Rated Temperature (°C)	Category Voltage (V)	Category Temperature (°C)	Maximum Surge Current (A)	DCL Max. (µA)	ESR Max. @ 100kHz (mΩ)	100kHz RMS Current (mA)			Product Category	MSL
										25°C	85°C	125°C		
2.5 Volt @ 40°C														
TLJT227M002#1200	T	220	2.5	40	0.5	125	0.8	5.5	1100	270	243	108	2	3
4 Volt @ 40°C														
TLJN336M004#8000	N	33	4	40	0.8	125	0.2	1.3	8000	79	71	32	1	3
TLJR336M004#3000	R	33	4	40	0.8	125	0.6	1.3	3000	135	122	54	2	3
TLJK476M004#1500	K	47	4	40	0.8	125	1.0	1.9	1500	208	187	83	2	3
TLJN476M004#4000	N	47	4	40	0.8	125	0.6	1.9	4000	112	101	45	1	3
TLJP476M004#3000	P	47	4	40	0.8	125	0.6	1.9	3000	141	127	57	2	3
TLJR476M004#3000	R	47	4	40	0.8	125	0.6	1.9	3000	135	122	54	2	3
TLJK686M004#1200	K	68	4	40	0.8	125	1.2	2.7	1200	233	209	93	2	3
TLJN686M004#8000	N	68	4	40	0.8	125	0.2	5.4	8000	79	71	32	1	3
TLJP686M004#3000	P	68	4	40	0.8	125	1.2	2.7	3000	141	127	57	2	3
TLJR686M004#2900	R	68	4	40	0.8	125	0.6	2.7	2900	138	124	55	2	3
TLJS686M004#1500	S	68	4	40	0.8	125	1.0	2.7	1500	208	187	83	2	3
TLJA107M004#0500	A	100	4	40	0.8	125	2.1	4.0	500	387	349	155	1	3
TLJG107M004#0800	G	100	4	40	0.8	125	1.6	4.0	800	296	266	118	2	3
TLJK107M004#2000	K	100	4	40	0.8	125	0.8	8.0	2000	180	162	72	2	3
TLJP107M004#2700	P	100	4	40	0.8	125	0.6	8.0	2700	149	134	60	2	3
TLJS107M004#1400	S	100	4	40	0.8	125	1.1	4.0	1400	215	194	86	2	3
TLJA157M004#0800	A	150	4	40	0.8	125	1.6	6.0	800	306	276	122	2	3
TLJT157M004#0800	T	150	4	40	0.8	125	1.6	6.0	800	316	285	126	2	3
TLJA227M004#1100	A	220	4	40	0.8	125	1.3	17.6	1100	261	235	104	2	3
TLJG227M004#3000	G	220	4	40	0.8	125	0.6	17.6	3000	153	137	61	2	3
TLJH227M004#0900	H	220	4	40	0.8	125	1.5	8.8	900	298	268	119	2	3
TLJT227M004#1100	T	220	4	40	0.8	125	1.3	17.6	1100	270	243	108	2	3
TLJT337M004#2700	T	330	4	40	0.8	125	0.6	26.4	2700	172	155	69	2	3
TLJW337M004#0200	W	330	4	40	0.8	125	3.1	13.2	200	671	604	268	1	3
6.3 Volt @ 40°C														
TLJN226M006#5400	N	22	6.3	40	1.3	125	0.5	1.3	5400	96	87	38	1	3
TLJR226M006#3500	R	22	6.3	40	1.3	125	0.8	1.3	3500	125	113	50	2	3
TLJK336M006#1700	K	33	6.3	40	1.3	125	1.5	2.0	1700	196	176	78	2	3
TLJN336M006#8000	N	33	6.3	40	1.3	125	0.4	2.0	8000	79	71	32	1	3
TLJP336M006#3000	P	33	6.3	40	1.3	125	0.9	2.0	3000	141	127	57	1	3
TLJR336M006#3000	R	33	6.3	40	1.3	125	0.9	2.0	3000	135	122	54	2	3
TLJK476M006#1500	K	47	6.3	40	1.3	125	1.6	2.8	1500	208	187	83	2	3
TLJN476M006#8300	N	47	6.3	40	1.3	125	0.4	5.6	8300	78	70	31	1	3
TLJP476M006#0700	P	47	6.3	40	1.3	125	2.7	2.8	700	293	263	117	2	3
TLJP476M006#0900	P	47	6.3	40	1.3	125	2.3	2.8	900	258	232	103	2	3
TLJP476M006#1800	P	47	6.3	40	1.3	125	1.4	2.8	1800	183	164	73	2	3
TLJP476M006#2500	P	47	6.3	40	1.3	125	1.1	2.8	2500	155	139	62	2	3
TLJR476M006#3200	R	47	6.3	40	1.3	125	0.9	2.8	3200	131	118	52	2	3
TLJS476M006#1500	S	47	6.3	40	1.3	125	1.6	2.8	1500	208	187	83	2	3
TLJA686M006#0500	A	68	6.3	40	1.3	125	3.3	4.1	500	387	349	155	1	3
TLJG686M006#0800	G	68	6.3	40	1.3	125	1.9	4.1	800	296	266	118	2	3
TLJK686M006#2000	K	68	6.3	40	1.3	125	1.3	8.16	2000	180	162	72	2	3
TLJS686M006#1500	S	68	6.3	40	1.3	125	1.6	4.1	1500	208	187	83	2	3
TLJT686M006#0600	T	68	6.3	40	1.3	125	3.0	4.1	600	365	329	146	1	3
TLJA107M006#0500	A	100	6.3	40	1.3	125	3.3	6.0	500	387	349	155	2	3
TLJA107M006#0800	A	100	6.3	40	1.3	125	2.5	6.0	800	306	276	122	2	3
TLJG107M006#0800	G	100	6.3	40	1.3	125	2.5	6.0	800	296	266	118	2	3
TLJK107M006#2000	K	100	6.3	40	1.3	125	1.3	12.0	2000	180	162	72	2	3
TLJP107M006#5400	P	100	6.3	40	1.3	125	0.5	12.0	5400	105	95	42	2	3
TLJT107M006#0800	T	100	6.3	40	1.3	125	2.5	6.0	800	316	285	126	2	3
TLJA157M006#0900	A	150	6.3	40	1.3	125	2.3	9.0	900	289	260	115	2	3
TLJH157M006#0900	H	150	6.3	40	1.3	125	2.3	9.0	900	298	268	119	2	3
TLJT157M006#1200	T	150	6.3	40	1.3	125	1.9	9.0	1200	258	232	103	2	3
TLJB227M006#0500	B	220	6.3	40	1.3	125	3.3	13.2	500	412	371	165	1	3
TLJT227M006#2000	T	220	6.3	40	1.3	125	1.3	26.4	2000	200	180	80	2	3
TLJW227M006#0200	W	220	6.3	40	1.3	125	4.8	13.2	200	671	604	268	1	3
TLJF337M006#0300	F	330	6.3	40	1.3	125	4.2	19.8	300	577	520	231	1	3
TLJY687M006#0100	Y	680	6.3	40	1.3	125	5.7	40.8	100	1118	1006	447	1	3
TLJY687M006#0150	Y	680	6.3	40	1.3	125	5.7	40.8	150	913	822	365	1	3
TLJV158M006#0100	V	1500	6.3	40	1.3	125	5.7	90	100	1581	1423	632	1	3

TLJ Series

Tantalum Solid Electrolytic Chip Capacitors - High CV Consumer Series



RATINGS & PART NUMBER REFERENCE

AVX Part No.	Case Size	Capacitance (µF)	Rated Voltage (V)	Rated Temperature (°C)	Category Voltage (V)	Category Temperature (°C)	Maximum Surge Current (A)	DCL Max. (µA)	ESR Max. @ 100kHz (mΩ)	100kHz RMS Current (mA)			Product Category	MSL
										25°C	85°C	125°C		
10 Volt @ 40°C														
TLJN106M010#2500	N	10	10	40	2	125	1.7	1.0	2500	141	127	57	1	3
TLJR106M010#2000	R	10	10	40	2	125	2.0	1.0	2000	166	149	66	1	3
TLJR106M010#3000	R	10	10	40	2	125	1.4	1.0	3000	135	122	54	1	3
TLJR156M010#2000	R	15	10	40	2	125	2.0	1.5	2000	166	149	66	1	3
TLJK226M010#1800	K	22	10	40	2	125	2.2	2.2	1800	167	150	67	2	3
TLJN226M010#3800	N	22	10	40	2	125	1.2	2.2	3800	115	103	46	1	3
TLJR226M010#3800	R	22	10	40	2	125	1.2	2.2	3800	120	108	48	2	3
TLJK336M010#1500	K	33	10	40	2	125	2.6	3.3	1500	208	187	83	2	3
TLJN336M010#9600	N	33	10	40	2	125	0.5	6.6	9600	72	65	29	1	3
TLJP336M010#3500	P	33	10	40	2	125	1.3	3.3	3500	131	118	52	2	3
TLJR336M010#3500	R	33	10	40	2	125	1.3	3.3	3500	125	113	50	2	3
TLJS336M010#1500	S	33	10	40	2	125	2.6	3.3	1500	208	187	83	2	3
TLJA476M010#0600	A	47	10	40	2	125	4.8	4.7	600	354	318	141	1	3
TLJG476M010#1500	G	47	10	40	2	125	2.6	4.7	1500	216	194	86	2	3
TLJP476M010#3200	P	47	10	40	2	125	1.4	4.7	3200	137	123	55	2	3
TLJR476M010#3200	R	47	10	40	2	125	1.4	9.4	3200	131	118	52	2	3
TLJS476M010#1500	S	47	10	40	2	125	2.6	4.7	1500	208	187	83	2	3
TLJT476M010#0600	T	47	10	40	2	125	4.8	4.7	600	365	329	146	1	3
TLJA686M010#1500	A	68	10	40	2	125	2.6	6.8	1500	224	201	89	2	3
TLJA107M010#1400	A	100	10	40	2	125	2.7	10.0	1400	231	208	93	2	3
TLJH107M010#0900	H	100	10	40	2	125	3.7	10.0	900	298	268	119	2	3
TLJT107M010#0900	T	100	10	40	2	125	3.7	10.0	900	298	268	119	2	3
TLJB157M010#0500	B	150	10	40	2	125	5.3	15.0	500	412	371	165	1	3
TLJW157M010#0150	W	150	10	40	2	125	8.3	15.0	150	775	697	310	1	3
TLJW157M010#0200	W	150	10	40	2	125	7.7	15.0	200	671	604	268	1	3
TLJF227M010#0300	F	220	10	40	2	125	6.7	22.0	300	577	520	231	1	3
16 Volt @ 40°C														
TLJS106M016#2200	S	10	16	40	3.2	125	3.0	1.6	2200	172	155	69	1	3
TLJT226M016#1000	T	22	16	40	3.2	125	5.5	3.5	1000	283	255	113	1	3
TLJT336M016#1000	T	33	16	40	3.2	125	5.5	5.3	1000	283	255	113	1	3
20 Volt @ 40°C														
TLJT106M020#1000	T	10	20	40	4	125	6.9	2.0	1000	283	255	113	1	3

Moisture Sensitivity Level (MSL) is defined according to J-STD-020.

All technical data relates to an ambient temperature of +25°C. Capacitance is measured at 120Hz, 0.5V RMS with a maximum DC bias of 2.2 volts. DCL is measured at rated voltage after 5 minutes.

ESR allowed to move up to 1.25 times catalogue limit post mounting

DCL allowed to move up to 2.00 times catalogue limit post mounting

For typical weight and composition see page 274.

NOTE: AVX reserves the right to supply higher voltage ratings or tighter tolerance part in the same case size, to the same reliability standards.

TLJ Series

Tantalum Solid Electrolytic Chip Capacitors - High CV Consumer Series



QUALIFICATION TABLE – CATEGORY 1

TEST	TLJ series (Temperature range -55°C to +125°C)									
	Condition			Characteristics						
Endurance	Apply rated voltage (Ur) at 40°C and / or category voltage (Uc) at 85°C for 2000 hours through a circuit impedance of $\leq 0.1\Omega/V$. Stabilize at room temperature for 1-2 hours before measuring.			Visual examination	no visible damage					
				DCL	2 x initial limit					
				$\Delta C/C$	within $\pm 10\%$ of initial value					
				ESR	1.25 x initial limit					
Humidity	Store at 65°C and 90-95% relative humidity for 500 hours, with no applied voltage. Stabilize at room temperature and humidity for 1-2 hours before measuring.			Visual examination	no visible damage					
				DCL	2 x initial limit					
				$\Delta C/C$	within $\pm 10\%$ of initial value					
				ESR	1.25 x initial limit					
Temperature Stability	Step	Temperature°C	Duration(min)							
	1	+20	15	+20°C	-55°C	+20°C	+85°C	+125°C	+20°C	
	2	-55	15	DCL	2 x IL*	n/a	2 x IL*	20 x IL*	25 x IL*	IL*
	3	+20	15	$\Delta C/C$	n/a	+0/-20%	$\pm 5\%$	+20/-0%	+25/-0%	$\pm 5\%$
	4	+85	15	ESR	1.25 x IL*	2.5 x IL*	1.25 x IL*	1.25 x IL*	1.25 x IL*	1.25 x IL*
	5	+125	15							
	6	+20	15							
Surge Voltage	Apply 1.3x rated voltage (Ur) at 40°C for 1000 cycles of duration 6 min (30 sec charge, 5 min 30 sec discharge) through a charge / discharge resistance of 1000 Ω			Visual examination	no visible damage					
				DCL	2 x initial limit					
				$\Delta C/C$	within $\pm 5\%$ of initial value					
				ESR	1.25 x initial limit					
Mechanical Shock	MIL-STD-202, Method 213, Condition C			Visual examination	no visible damage					
				DCL	initial limit					
				$\Delta C/C$	within $\pm 5\%$ of initial value					
				ESR	initial limit					
Vibration	MIL-STD-202, Method 204, Condition D			Visual examination	no visible damage					
				DCL	initial limit					
				$\Delta C/C$	within $\pm 5\%$ of initial value					
				ESR	initial limit					

*Initial Limit

QUALIFICATION TABLE – CATEGORY 2

TEST	TLJ series (Temperature range -55°C to +125°C)									
	Condition			Characteristics						
Endurance	Apply rated voltage (Ur) at 40°C and / or category voltage (Uc) at 85°C for 2000 hours through a circuit impedance of $\leq 0.1\Omega/V$. Stabilize at room temperature for 1-2 hours before measuring.			Visual examination	no visible damage					
				DCL	2 x initial limit					
				$\Delta C/C$	within +5/-30% of initial value					
				ESR	1.25 x initial limit					
Humidity	Store at 65°C and 90-95% relative humidity for 500 hours, with no applied voltage. Stabilize at room temperature and humidity for 1-2 hours before measuring.			Visual examination	no visible damage					
				DCL	2 x initial limit					
				$\Delta C/C$	within $\pm 10\%$ of initial value					
				ESR	1.25 x initial limit					
Temperature Stability	Step	Temperature°C	Duration(min)							
	1	+20	15	+20°C	-55°C	+20°C	+85°C	+125°C	+20°C	
	2	-55	15	DCL	2 x IL*	n/a	2 x IL*	20 x IL*	25 x IL*	2 x IL*
	3	+20	15	$\Delta C/C$	n/a	+5/-20%	$\pm 10\%$	+20/-0%	+25/-0%	$\pm 10\%$
	4	+85	15	ESR	1.25 x IL*	2.5 x IL*	1.25 x IL*	1.25 x IL*	1.25 x IL*	1.25 x IL*
	5	+125	15							
	6	+20	15							
Surge Voltage	Apply 1.3x rated voltage (Ur) at 40°C for 1000 cycles of duration 6 min (30 sec charge, 5 min 30 sec discharge) through a charge / discharge resistance of 1000 Ω			Visual examination	no visible damage					
				DCL	2 x initial limit					
				$\Delta C/C$	within $\pm 5\%$ of initial value					
				ESR	1.25 x initial limit					
Mechanical Shock	MIL-STD-202, Method 213, Condition C			Visual examination	no visible damage					
				DCL	initial limit					
				$\Delta C/C$	within $\pm 5\%$ of initial value					
				ESR	initial limit					
Vibration	MIL-STD-202, Method 204, Condition D			Visual examination	no visible damage					
				DCL	initial limit					
				$\Delta C/C$	within $\pm 5\%$ of initial value					
				ESR	initial limit					

*Initial Limit

TLJ Series

Tantalum Solid Electrolytic Chip Capacitors - High CV Consumer Series



AVX SOLID ELECTROLYTIC CAPACITOR ROADMAP

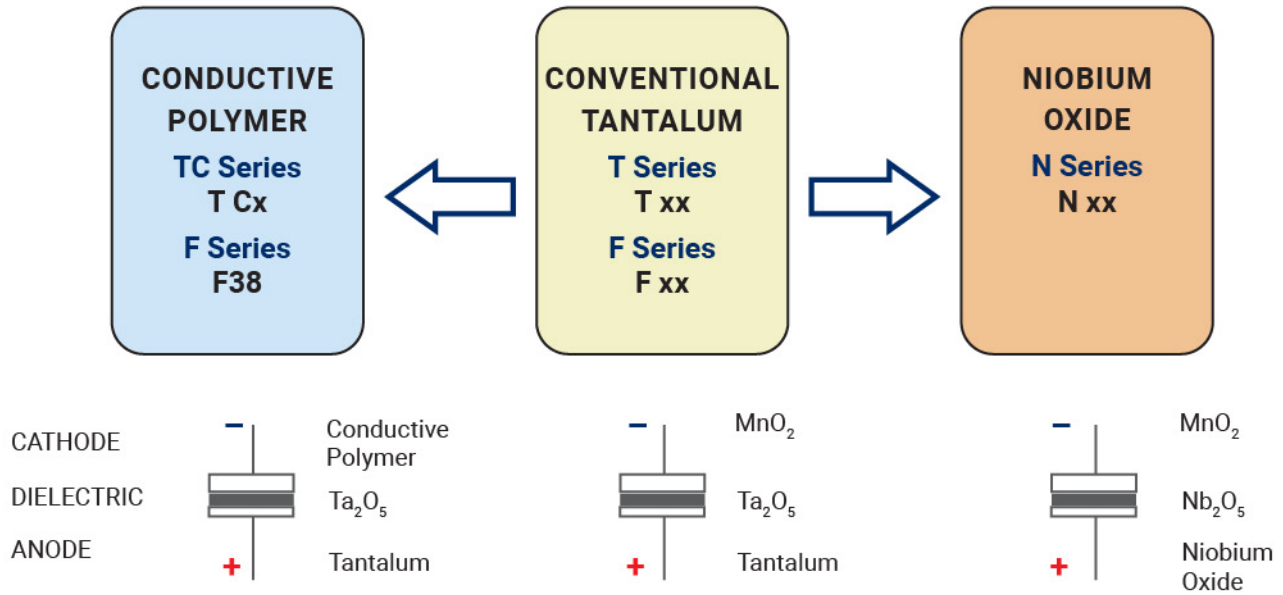

FIVE CAPACITOR CONSTRUCTION STYLES

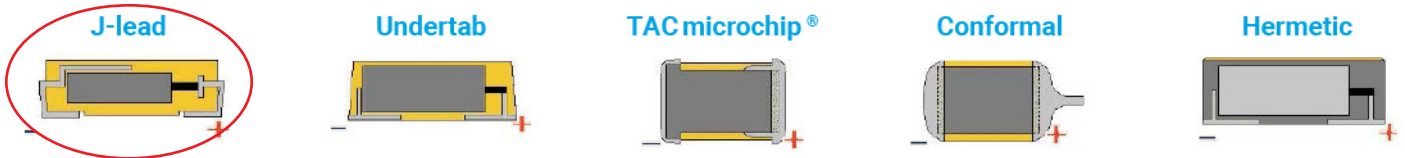

SERIES LINE UP : CONVENTIONAL SMD MnO₂

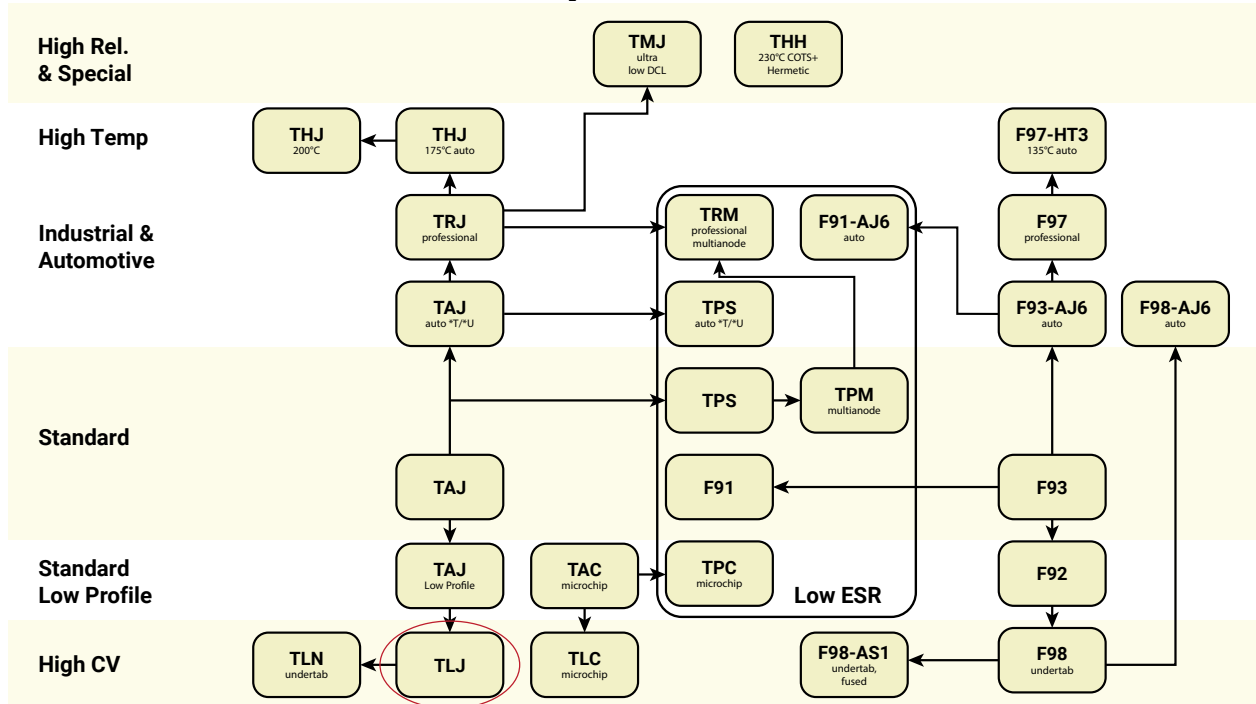

TLN Series

Tantalum Solid Electrolytic Chip Capacitors - Undertab Series



FEATURES

- Undertab Terminations Layout:
 - High Volumetric Efficiency
 - High PCB Assembly Density
 - High Capacitance in Smaller Dimensions
- 3x Reflow 260°C Compatible
- 100% Surge Current Tested
- Consumer Applications (e.g. PCMCIA/USB Wireless Express Cards, Mobiles, MP3 etc.)
- 6 Case Sizes Available
- CV Range: 47-220µF / 4-10V



LEAD-FREE
LEAD-FREE COMPATIBLE
COMPONENT



RoHS
COMPLIANT

APPLICATIONS

- Mobile Phones
- Tablets
- MP3/4 Players

CASE DIMENSIONS:

millimeters (inches)

Code	EIA Code	EIA Metric	L±0.20 (0.008)	W±0.20 (0.008) -0.10 (0.004)	H max.	W _P ±0.10 (0.004)	W _N ±0.10 (0.004)	A _P ±0.10 (0.004)	A _N ±0.10 (0.004)	S Min.
M	0805	2012-09	2.05 (0.081)	1.30 (0.051)	0.90 (0.035)	1.00 (0.039)	1.00 (0.039)	0.85 (0.033)	0.85 (0.033)	0.40 (0.016)
N	0805	2012-10	2.05 (0.081)	1.30 (0.051)	1.00 (0.039)	1.00 (0.039)	1.00 (0.039)	0.85 (0.033)	0.85 (0.033)	0.40 (0.016)
K	1206	3216-10	3.20 (0.126)	1.60 (0.063)	1.00 (0.039)	1.30 (0.051)	1.30 (0.051)	1.15 (0.045)	1.15 (0.045)	0.90 (0.035)
S	1206	3216-12	3.20 (0.126)	1.60 (0.063)	1.20 (0.047)	1.30 (0.051)	1.30 (0.051)	1.15 (0.045)	1.15 (0.045)	0.90 (0.035)
L	1210	3528-10	3.50 (0.138)	2.80 (0.110)	1.00 (0.039)	2.50 (0.098)	2.10 (0.083)	1.15 (0.045)	1.35 (0.053)	1.00 (0.039)
T	1210	3528-12	3.50 (0.138)	2.80 (0.110)	1.20 (0.047)	2.50 (0.098)	2.10 (0.083)	1.15 (0.045)	1.35 (0.053)	1.00 (0.039)

MARKING

K, L, S, T, CASE

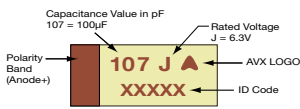

M, N CASE

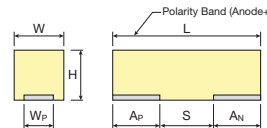
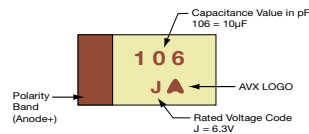

HOW TO ORDER

TLN

Type

S

Case Size
See table above

227

Capacitance Code
pF code: 1st two digits represent significant figures, 3rd digit represents multiplier (number of zeros to follow)

M

Tolerance
M = ±20%

004

Rated DC Voltage
004 = 4Vdc
006 = 6.3Vdc
010 = 10Vdc

R

Packaging
R = Pure Tin 7" Reel
S = Pure Tin 13" Reel

3000

ESR in mΩ

TECHNICAL SPECIFICATIONS

Technical Data:	All technical data relate to an ambient temperature of +25°C				
Capacitance Range:	47 µF to 220 µF				
Capacitance Tolerance:	±20%				
Rated Voltage (V _R)	-55°C ≤ +40°C:	4	6.3	10	
Category Voltage (V _C)	at 85°C:	2	3.2	5	
Category Voltage (V _C)	at 125°C:	0.8	1.3	2	
Temperature Range:	-55°C to +125°C with category voltage				
Reliability:	0.2% per 1000 hours at 85°C, 0.5xV _R with 0.1Ω/V series impedance with 60% confidence level				

TLN Series

Tantalum Solid Electrolytic Chip Capacitors - Undertab Series



CAPACITANCE AND RATED VOLTAGE RANGE (LETTER DENOTES CASE SIZE)

Capacitance		Rated Voltage DC to 40°C / 0.5DC to 85°C/ 0.2DC to 125°C		
µF	Code	4V (G)	6.3V (J)	10V (A)
33	336			
47	476			K(1500)/M(6000)/N(6000)
68	686		K(5400)	K(5400)/S(6000)
100	107	N(5200)	K(2000,5400)/S(5400)	K(2500)/S(2500)
150	157	K(2500)/S(2500)	K(2500)/S(2500)	H(6000)/L(1300)/T(1500)
220	227	K(2500)/L(1300) S(3000)/T(1500)	L(1000)/T(1500)	T(1300)

Released ratings, (ESR ratings in mOhms in parentheses)

Engineering samples - please contact AVX

Note: Voltage ratings are minimum values. AVX reserves the right to supply higher voltage ratings in the same case size, to the same reliability standards.

RATINGS & PART NUMBER REFERENCE

AVX Part No.	Case Size	Capacitance (µF)	Rated Voltage (V)	Rated Temperature (°C)	Category Voltage (V)	Category Temperature (°C)	Maximum Surge Current (A)	DCL Max. (µA)	ESR Max. @ 100kHz (mΩ)	100kHz RMS Current (mA)			MSL
										25°C	85°C	125°C	
4 Volt @ 40°C													
TLNN107M004#5200	N	100	4	40	0.8	125	0.4	20	5200	88	79	35	3
TLNK157M004#2500	K	150	4	40	0.8	125	0.7	12	2500	148	133	59	3
TLNS157M004#2500	S	150	4	40	0.8	125	0.7	12	2500	148	133	59	3
TLNK227M004#2500	K	220	4	40	0.8	125	0.7	44	2500	148	133	59	3
TLNL227M004#1300	L	220	4	40	0.8	125	1.1	17.6	1300	215	193	86	3
TLNS227M004#3000	S	220	4	40	0.8	125	0.6	17.6	3000	135	122	54	3
TLNT227M004#1500	T	220	4	40	0.8	125	1.0	17.6	1500	216	194	86	3
6.3 Volt @ 40°C													
TLNK686M006#5400	K	68	6.3	40	1.3	125	0.5	4.1	5400	101	91	40	3
TLNK107M006#2000	K	100	6.3	40	1.3	125	1.3	12	2000	166	149	66	3
TLNK107M006#5400	K	100	6.3	40	1.3	125	0.5	6	5400	101	91	40	3
TLNS107M006#5400	S	100	6.3	40	1.3	125	0.5	6	5400	101	91	40	3
TLNK157M006#2500	K	150	6.3	40	1.3	125	1.1	18	2500	148	133	59	3
TLNS157M006#2500	S	150	6.3	40	1.3	125	1.1	18	2500	148	133	59	3
TLNL227M006#1000	L	220	6.3	40	1.3	125	2.2	26.4	1000	245	220	98	3
TLNT227M006#1500	T	220	6.3	40	1.3	125	1.6	26.4	1500	216	194	86	3
10 Volt @ 40°C													
TLNK476M010#1500	K	47	10	40	2	125	2.6	4.7	1500	191	172	77	3
TLNM476M010#6000	M	47	10	40	2	125	0.8	9.4	6000	82	73	33	3
TLNN476M010#6000	N	47	10	40	2	125	0.8	9.4	6000	82	73	33	3
TLNK686M010#5400	K	68	10	40	2	125	0.9	6.8	5400	101	91	40	3
TLNS686M010#6000	S	68	10	40	2	125	0.8	6.8	6000	96	86	38	3
TLNK107M010#2500	K	100	10	40	2	125	1.7	20	2500	148	133	59	3
TLNS107M010#2500	S	100	10	40	2	125	1.7	10	2500	148	133	59	3
TLNH157M010#6000	H	150	10	40	2	125	0.8	30	6000	108	97	43	3
TLNL157M010#1300	L	150	10	40	2	125	2.9	30	1300	215	193	86	3
TLNT157M010#1500	T	150	10	40	2	125	2.6	30	1500	216	194	86	3
TLNT227M010#1300	T	220	10	40	2	125	2.9	44	1300	232	209	93	3

Moisture Sensitivity Level (MSL) is defined according to J-STD-020.

All technical data relates to an ambient temperature of +25°C. Capacitance is measured at 120Hz, 0.5V RMS with a maximum DC bias of 2.2 volts.

DCL is measured at rated voltage after 5 minutes.

ESR allowed to move up to 1.25 times catalogue limit post mounting

DCL allowed to move up to 2.00 times catalogue limit post mounting

For typical weight and composition see page 274.

NOTE: AVX reserves the right to supply higher voltage ratings or tighter tolerance part in the same case size, to the same reliability standards.

QUALIFICATION TABLE

TEST	TLN series (Temperature range -55°C to +125°C)										
	Condition			Characteristics							
Endurance	Apply rated voltage (Ur) at 40°C and / or category voltage (Uc) at 85°C for 2000 hours through a circuit impedance of ≤0.1Ω/V. Stabilize at room temperature for 1-2 hours before measuring.			Visual examination		no visible damage					
				DCL		2 x initial limit					
				ΔC/C		within +5/-30% of initial value					
				ESR		1.25 x initial limit					
Humidity	Store at 65°C and 90-95% relative humidity for 500 hours, with no applied voltage. Stabilize at room temperature and humidity for 1-2 hours before measuring.			Visual examination		no visible damage					
				DCL		2 x initial limit					
				ΔC/C		within ±10% of initial value					
				ESR		1.25 x initial limit					
Temperature Stability	Step	Temperature°C	Duration(min)								
	1	+20	15			+20°C	-55°C	+20°C	+85°C	+125°C	+20°C
	2	-55	15	DCL		2 x IL*	n/a	2 x IL*	20 x IL*	25 x IL*	2 x IL*
	3	+20	15	ΔC/C		n/a	+5/-20%	±10%	+20/-0%	+25/-0%	±10%
	4	+85	15	ESR		1.25xIL*	2.5 x IL*	1.25 x IL*	1.25 x IL*	1.25 x IL*	1.25xIL*
	5	+125	15								
	6	+20	15								
Surge Voltage	Apply 1.3x rated voltage (Ur) at 40°C for 1000 cycles of duration 6 min (30 sec charge, 5 min 30 sec discharge) through a charge / discharge resistance of 1000Ω			Visual examination		no visible damage					
				DCL		2 x initial limit					
				ΔC/C		within ±5% of initial value					
				ESR		1.25 x initial limit					
Mechanical Shock	MIL-STD-202, Method 213, Condition C			Visual examination		no visible damage					
				DCL		initial limit					
				ΔC/C		within ±5% of initial value					
				DF		initial limit					
				ESR		initial limit					
Vibration	MIL-STD-202, Method 204, Condition D			Visual examination		no visible damage					
				DCL		initial limit					
				ΔC/C		within ±5% of initial value					
				DF		initial limit					
				ESR		initial limit					

*Initial Limit

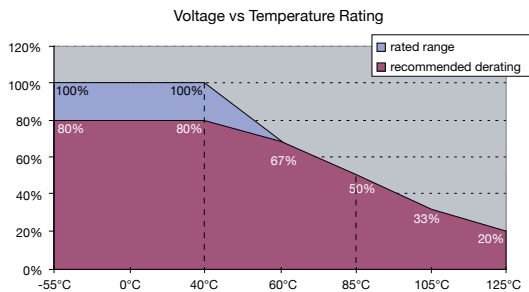

TLN Series

Tantalum Solid Electrolytic Chip Capacitors - Undertab Series

AVX SOLID ELECTROLYTIC CAPACITOR ROADMAP

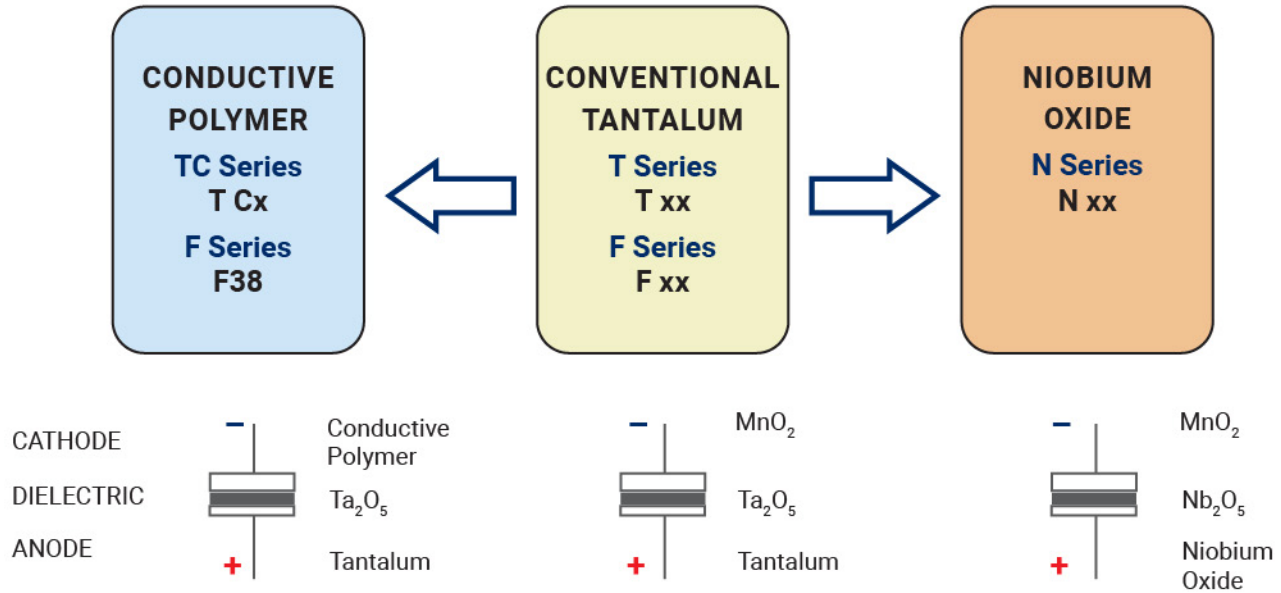

FIVE CAPACITOR CONSTRUCTION STYLES

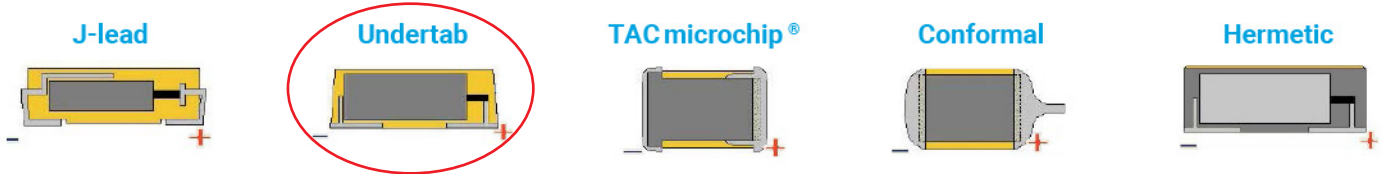

SERIES LINE UP : CONVENTIONAL SMD MnO₂

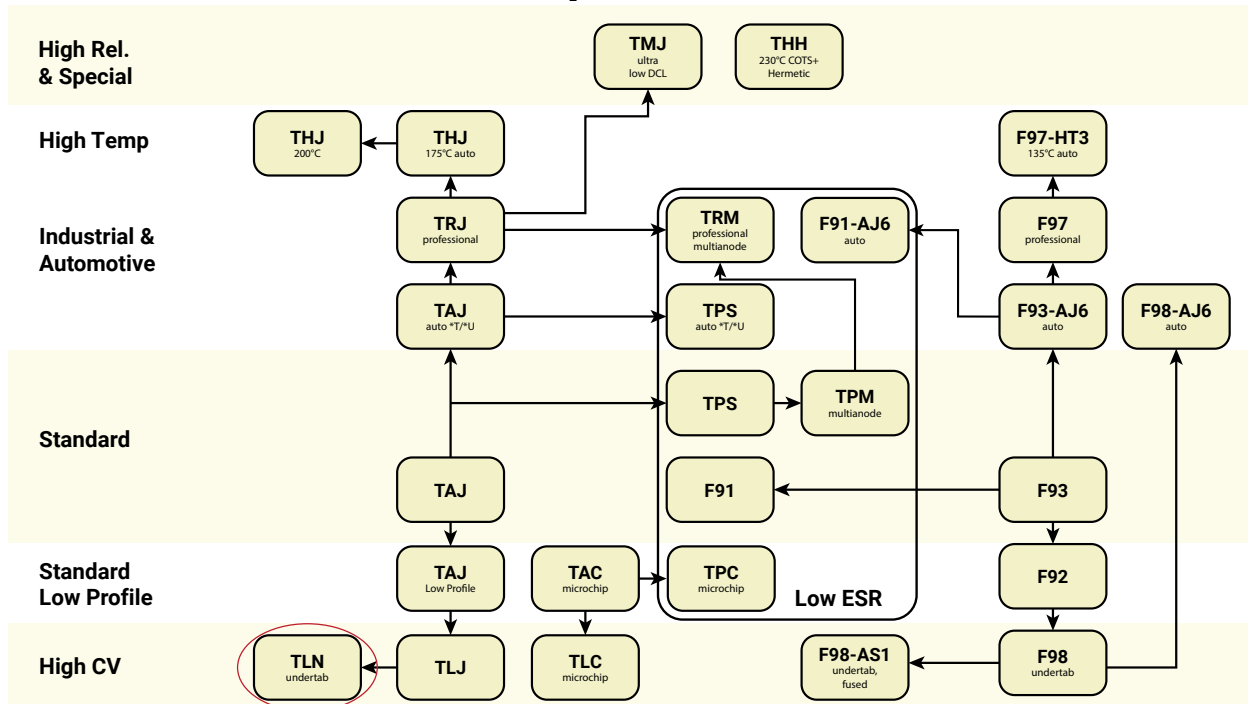

TLN PulseCap™ Series

High Capacitance Tantalum Solid Electrolytic Chip Capacitors Undertab Series



FEATURES

- Large Case Size for Maximum Capacitance
- 3x Reflow 260°C Compatible
- 100% Surge Current Tested
- Low Profile Solution
- Consumer Applications (e.g. PCMCIA/USB Wireless Express Cards etc.)
- CV Range: 1000-3300µF / 4-10V
- 2 Case Sizes Available

APPLICATIONS

- Data Transfer Modems
- SSD Backup Circuits



LEAD-FREE
LEAD-FREE COMPATIBLE
COMPONENT



RoHS
COMPLIANT

CASE DIMENSIONS:

millimeters (inches)

Code	EIA Code	EIA Metric	L±0.20 (0.008)	W+0.20 (0.008) -0.10 (0.004)	H max.	W _P ±0.10 (0.004)	W _N ±0.10 (0.004)	A _P ±0.10 (0.004)	A _N ±0.10 (0.004)	S Min.
4	2924	7361-20	7.30 (0.287)	6.10 (0.240)	2.00 (0.079)	4.75 (0.187)	4.75 (0.187)	2.00 (0.079)	3.20 (0.126)	2.10 (0.083)
6	5831	14878-20	14.80 (0.583)	7.80 (0.307)	2.00 (0.079)	5.50 (0.217)	5.50 (0.217)	2.45 (0.096)	2.45 (0.096)	9.90 (0.390)

MARKING

4, 6 CASE

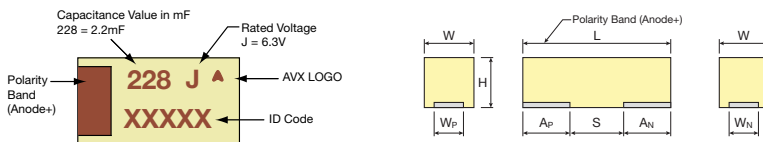

HOW TO ORDER

TLN

Type

6

Case Size
See table above

228

Capacitance Code
pF code: 1st two digits represent significant figures, 3rd digit represents multiplier

M

Tolerance
M = ±20%

006

Rated DC Voltage
004 = 4Vdc
006 = 6.3Vdc
010 = 10Vdc

R

Packaging
R = Pure Tin 7" Reel

0055

ESR in mΩ

TECHNICAL SPECIFICATIONS

Technical Data:	All technical data relate to an ambient temperature of +25°C				
Capacitance Range:	1000 µF to 3300 µF				
Capacitance Tolerance:	±20%				
Leakage Current DCL:	0.01CV				
Rated Voltage (V _R)	-55°C ≤ +40°C:	4	6.3	10	
Category Voltage (V _C)	at 85°C:	2	3.2	5	
Category Voltage (V _C)	at 125°C:	0.8	1.3	2	
Temperature Range:	-55°C to +125°C with category voltage				
Reliability:	0.2% per 1000 hours at 85°C, 0.5xV _R with 0.1Ω/V series impedance with 60% confidence level				

TLN PulseCap™ Series

High Capacitance Tantalum Solid Electrolytic Chip Capacitors Undertab Series



CAPACITANCE AND RATED VOLTAGE RANGE (LETTER DENOTES CASE SIZE)

Capacitance		Voltage Rating DC (VR) to 85°C		
µF	Code	4V (G)	6.3V (J)	10V (A)
680	687			
1000	108			4(100)/6(55)
1500	158		4(100)	6(55)
2200	228		6(55)	
3300	338	6(55)		

Released ratings (ESR ratings in mOhms in parentheses)

Note: Voltage ratings are minimum values. AVX reserves the right to supply higher voltage ratings in the same case size, to the same reliability standards.

RATINGS & PART NUMBER REFERENCE

AVX Part No.	Case Size	Capacitance (µF)	Rated Voltage (V)	Rated Temperature (°C)	Category Voltage (V)	Category Temperature (°C)	DCL Max. (µA)	ESR Max. @ 100kHz (mΩ)	100kHz RMS Current (mA)			MSL
									25°C	85°C	125°C	
4 Volt @ 40°C												
TLN6338M004#0055	6	3300	4	40	0.8	125	132	55	2045	1840	818	3
6.3 Volt @ 40°C												
TLN4158M006#0100	4	1500	6.3	40	1.3	125	90	100	1285	1156	514	3
TLN6228M006#0055	6	2200	6.3	40	1.3	125	132	55	2045	1840	818	3
10 Volt @ 40°C												
TLN4108M010#0100	4	1000	10	40	2	125	100	100	1285	1156	514	3
TLN6108M010#0055	6	1000	10	40	2	125	100	55	2045	1840	818	3
TLN6158M010#0055	6	1500	10	40	2	125	150	55	2045	1840	818	3

Moisture Sensitivity Level (MSL) is defined according to J-STD-020.

All technical data relates to an ambient temperature of +25°C. Capacitance and DF are measured at 120Hz, 0.5V RMS with a maximum DC bias of 2.2 volts.

DCL is measured at rated voltage after 5 minutes.

ESR allowed to move up to 1.25 times catalogue limit post mounting

DCL allowed to move up to 2.00 times catalogue limit post mounting

For typical weight and composition see page 274.

NOTE: AVX reserves the right to supply higher voltage ratings or tighter tolerance part in the same case size, to the same reliability standards.

TLN PulseCap™ Series

High Capacitance Tantalum Solid Electrolytic Chip Capacitors Undertab Series



QUALIFICATION TABLE

TEST	TLN PulseCap™ series (Temperature range -55°C to +125°C)									
	Condition			Characteristics						
Endurance	Apply rated voltage (Ur) at 40°C and / or category voltage (Uc) at 85°C for 2000 hours through a circuit impedance of $\leq 0.1\Omega/V$. Stabilize at room temperature for 1-2 hours before measuring.			Visual examination	no visible damage					
				DCL	2 x initial limit					
				$\Delta C/C$	within +5/-30% of initial value					
				ESR	1.25 x initial limit					
Humidity	Store at 65°C and 90-95% relative humidity for 500 hours, with no applied voltage. Stabilize at room temperature and humidity for 1-2 hours before measuring.			Visual examination	no visible damage					
				DCL	2 x initial limit					
				$\Delta C/C$	within $\pm 10\%$ of initial value					
				ESR	1.25 x initial limit					
Temperature Stability	Step	Temperature°C	Duration(min)		+20°C	-55°C	+20°C	+85°C	+125°C	+20°C
	1	+20	15	DCL	2 x IL*	n/a	2 x IL*	20 x IL*	25 x IL*	2 x IL*
	2	-55	15	$\Delta C/C$	n/a	+5/-20%	$\pm 10\%$	+20/-0%	+25/-0%	$\pm 10\%$
	3	+20	15	ESR	1.25xIL*	2.5 x IL*	1.25 x IL*	1.25 x IL*	1.25 x IL*	1.25xIL*
	4	+85	15							
	6	+20	15							
Surge Voltage	Apply 1.3x rated voltage (Ur) at 40°C for 1000 cycles of duration 6 min (30 sec charge, 5 min 30 sec discharge) through a charge / discharge resistance of 1000 Ω			Visual examination	no visible damage					
				DCL	2 x initial limit					
				$\Delta C/C$	within $\pm 5\%$ of initial value					
				ESR	1.25 x initial limit					
Mechanical Shock	MIL-STD-202, Method 213, Condition C			Visual examination	no visible damage					
				DCL	initial limit					
				$\Delta C/C$	within $\pm 5\%$ of initial value					
				DF	initial limit					
				ESR	initial limit					
Vibration	MIL-STD-202, Method 204, Condition D			Visual examination	no visible damage					
				DCL	initial limit					
				$\Delta C/C$	within $\pm 5\%$ of initial value					
				DF	initial limit					
				ESR	initial limit					

*Initial Limit

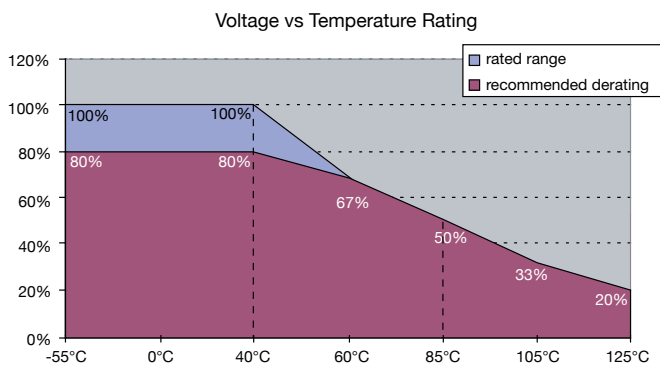

TLN PulseCap™ Series

High Capacitance Tantalum Solid Electrolytic Chip Capacitors Undertab Series



AVX SOLID ELECTROLYTIC CAPACITOR ROADMAP

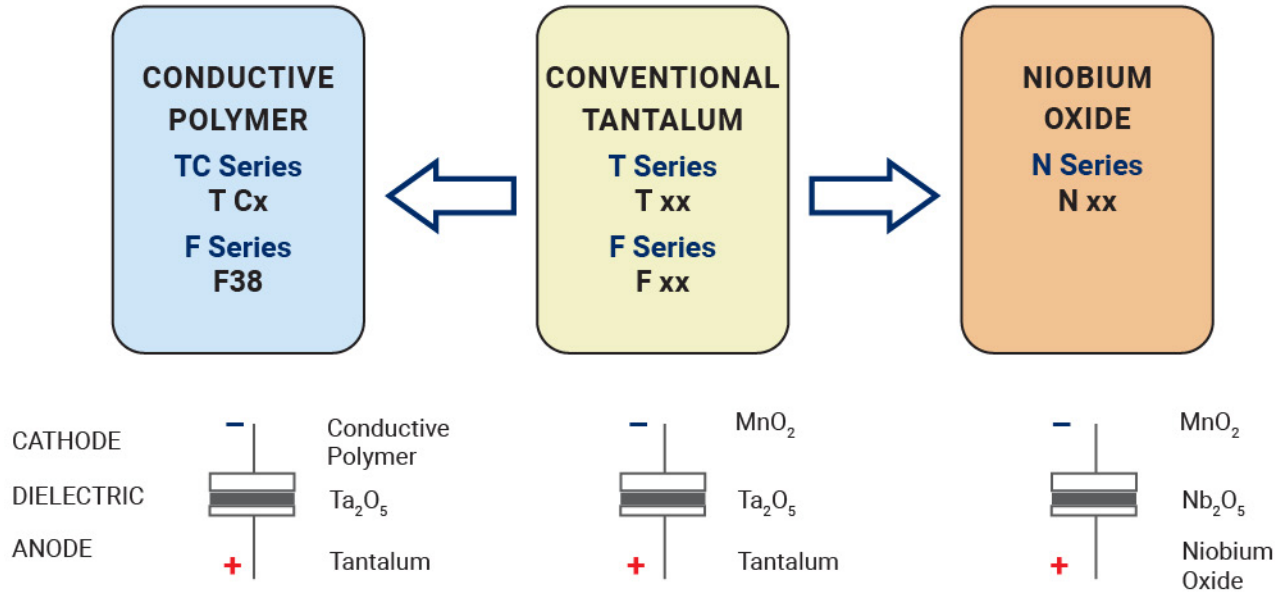

FIVE CAPACITOR CONSTRUCTION STYLES

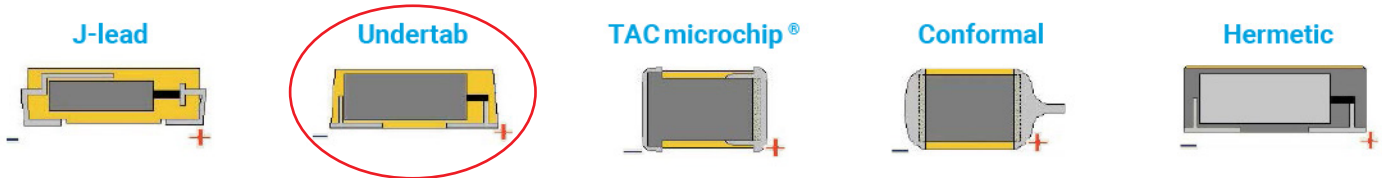

SERIES LINE UP : CONVENTIONAL SMD MnO₂

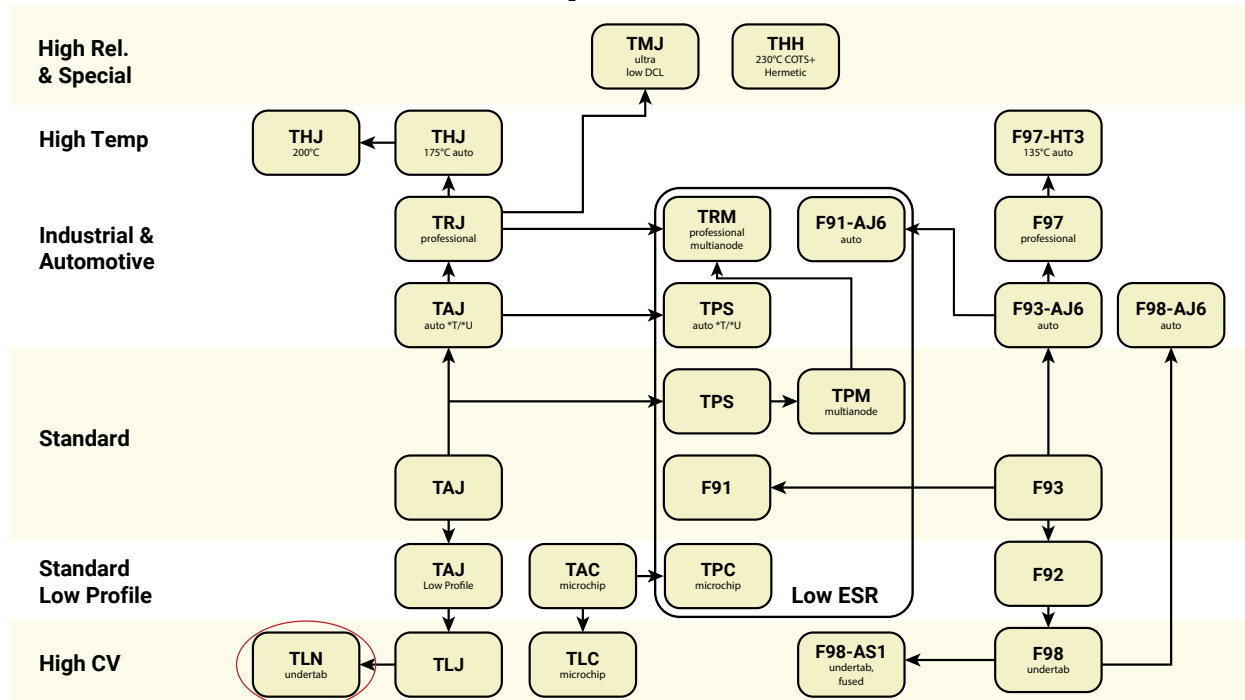

F98 Series

Resin-Molded Chip, High CV Undertab

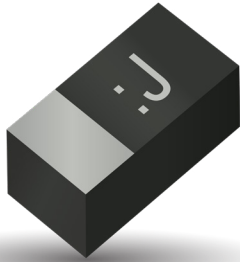

FEATURES

- Compliant to the RoHS3 directive 2015/863/EU
- SMD Face Down Design
- Small and Low Profile
- 100% Surge Current Tested



APPLICATIONS

- Smartphone
- Mobile Phone
- Wireless Module
- Hearing Aid

CASE DIMENSIONS:

millimeters (inches)

Code	EIA Code	EIA Metric	L	W ₁	W ₂	H	S ₁	S ₂
M	0603	1608-09	1.60 ^{+0.20} _{-0.10} (0.063 ^{+0.008} _{-0.004})	0.85 ^{+0.20} _{-0.10} (0.033 ^{+0.008} _{-0.004})	0.65±0.10 (0.026±0.004)	0.80±0.10*3 (0.031±0.004)	0.50±0.10 (0.020±0.004)	0.60±0.10 (0.024±0.004)
S	0805	2012-09	2.00 ^{+0.20} _{-0.10} (0.079 ^{+0.008} _{-0.004})	1.25 ^{+0.20} _{-0.10} (0.049 ^{+0.008} _{-0.004})	0.90±0.10 (0.035±0.004)	0.80±0.10 (0.031±0.004)	0.50±0.10 (0.020±0.004)	1.00±0.10 (0.039±0.004)
U	0402	1106-06	1.10±0.05 (0.043±0.002)	0.60±0.05 (0.024±0.002)	0.35±0.05 (0.014±0.002)	0.55±0.05 (0.022±0.002)	0.30±0.05 (0.012±0.002)	0.50±0.05 (0.020±0.002)

*3 F980J107MMAAXE: 1.0mm Max.

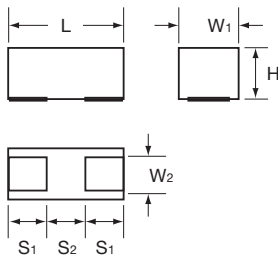

MARKING

U CASE



M CASE

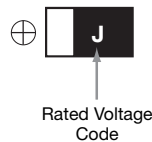

S CASE

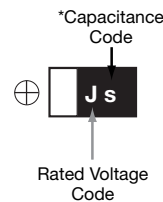

HOW TO ORDER

F98

Type

0J

Rated Voltage

106

Capacitance Code

pF code: 1st two digits represent significant figures, 3rd digit represents multiplier (number of zeros to follow)

M

Tolerance
M = ±20%

M

Case Size
See table above

□

Packaging
See Tape & Reel Packaging Section

□□□

Specification Suffix
LZT = Rated temperature 60°C
AXE = Rated temperature 60°C and H dimension 1.0mm Max

TECHNICAL SPECIFICATIONS

Category Temperature Range:	-55 to +125°C
Rated Temperature:	+85°C or +60°C
Capacitance Tolerance:	±20% at 120Hz
Dissipation Factor:	Refer to next page
ESR 100kHz:	Refer to next page
Leakage Current:	After 5 minute's application of rated voltage, leakage current at 85°C or +60°C 10 times or less than 20°C specified value. After 5 minute's application of rated voltage, leakage current at 125°C 12.5 times or less than 20°C specified value.
Termination Finish:	M, S case: Gold Plating (standard), U case: Sn-3.5Ag Plating (standard)

F98 Series

Resin-Molded Chip, High CV Undertab



CAPACITANCE AND RATED VOLTAGE RANGE (LETTER DENOTES CASE SIZE)

Capacitance		Rated Voltage								*Cap Code
µF	Code	2.5 (0e)	4V (0G)	6.3V (0J)	10V (1A)	16V (1C)	20V (1D)	25V (1E)	35V (1V)	
0.47	474					U				N
1.0	105					M	M	M	S	A
2.2	225				M/U	M				J
4.7	475		U	M/U	M/U**	M				S
10	106		U	M/U**	M	S				a
15	156		U							e
22	226		M/U**	M	M**/S					J
33	336		M	M	M**/S					n
47	476	M	M	M/S	S					s
68	686		M/S							w
100	107		M/S	M*4/S						A
220	227		S							J

Released ratings

*4 (AXE) Rated temperature 60°C and H dimension 1.0mm Max. Please contact AVX when you need detail spec.

** (LZT) Rated temperature 60°C. Please contact AVX when you need detail spec.

Please contact to your local AVX sales office when these series are being designed in your application.

RATINGS & PART NUMBER REFERENCE

AVX Part No.	Case Size	Capacitance (µF)	Rated Voltage (V)	DCL (µA)	DF @ 120Hz (%)	ESR @ 100kHz (Ω)	100kHz RMS Current (mA)				*1 ΔC/C (%)	MSL
							25°C	60°C	85°C	125°C		
2.5 Volt												
F980E476MMA	M	47	2.5	1.2	30	4	79	-	71	32	±30	3
4 Volt												
F980G475MUA	U	4.7	4	0.5	20	20	27	-	25	11	±30	3
F980G106MUA	U	10	4	0.8	25	20	27	-	25	11	±30	3
F980G156MUA	U	15	4	9.0	40	25	24	-	22	10	±30	3
F980G226MMA	M	22	4	0.9	15	7.5	58	-	52	23	±30	3
F980G226MUALZT	U	22	4	25.0	40	20	27	25	-	11	±30	3
F980G336MMA	M	33	4	1.3	30	4	79	-	71	32	±30	3
F980G476MMA	M	47	4	1.9	40	8	56	-	50	22	±30	3
F980G686MMA	M	68	4	27.2	50	10	50	-	45	20	±30	3
F980G686MSA	S	68	4	2.7	30	4	106	-	95	42	±30	3
F980G107MMA	M	100	4	80.0	60	10	50	-	45	20	±30	3
F980G107MSA	S	100	4	4.0	35	4	106	-	95	42	±30	3
F980G227MSA	S	220	4	132	80	5	95	-	85	38	±30	3
6.3 Volt												
F980J475MMA	M	4.7	6.3	0.5	20	7.5	58	-	52	23	±30	3
F980J475MUA	U	4.7	6.3	0.6	20	20	27	-	25	11	±30	3
F980J106MMA	M	10	6.3	0.6	8	6	65	-	58	26	±30	3
F980J106MUALZT	U	10	6.3	6.3	30	30	22	20	-	9	±30	3
F980J226MMA	M	22	6.3	1.4	20	6	65	-	58	26	±30	3
F980J336MMA	M	33	6.3	4.2	35	8	56	-	50	22	±30	3
F980J476MMA	M	47	6.3	29.6	45	10	50	-	45	20	±30	3
F980J476MSA	S	47	6.3	3.0	25	6	87	-	78	35	±30	3
F980J107MMAAXE	M	100	6.3	126	80	10	50	45	-	20	±30	3
F980J107MSA	S	100	6.3	63.0	50	8	75	-	68	30	±30	3
10 Volt												
F981A225MMA	M	2.2	10	0.5	6	7.5	58	-	52	23	±30	3
F981A225MUA	U	2.2	10	0.5	15	15	32	-	28	13	±30	3
F981A475MMA	M	4.7	10	0.5	6	6	65	-	58	26	±30	3
F981A475MUALZT	U	4.7	10	4.7	25	25	24	22	-	10	±30	3
F981A106MMA	M	10	10	1.0	20	7.5	58	-	52	23	±30	3
F981A226MUALZT	M	22	10	11.0	30	8	56	50	-	22	±30	3
F981A226MSA	S	22	10	2.2	20	4	106	-	95	42	±30	3
F981A336MUALZT	M	33	10	33.0	45	8	56	50	-	22	±30	3
F981A336MSA	S	33	10	3.3	30	6	87	-	78	35	±30	3
F981A476MSA	S	47	10	9.4	35	5	95	-	85	38	±30	3
16 Volt												
F981C474MUA	U	0.47	16	0.5	6	25	24	-	22	10	±20	3
F981C105MMA	M	1	16	0.5	6	10	50	-	45	20	±30	3
F981C225MMA	M	2.2	16	0.5	6	10	50	-	45	20	±30	3
F981C475MMA	M	4.7	16	0.8	12	12	46	-	41	18	±30	3
F981C106MSA	S	10	16	1.6	18	4	106	-	95	42	±30	3
20 Volt												
F981D105MMA	M	1	20	0.5	6	10	50	-	45	20	±30	3
25 Volt												
F981E105MMA	M	1	25	0.5	8	10	50	-	45	20	±30	3
35 Volt												
F981V105MSA	S	1	35	0.7	20	8	75	-	68	30	±30	3

*2: Leakage Current

After 5 minute's application of rated voltage, leakage current at 20°C.

Moisture Sensitivity Level (MSL) is defined according to J-STD-020.



The Important Information/Disclaimer is incorporated in the catalog where these specifications came from or available online at www.avx.com/disclaimer/ by reference and should be reviewed in full before placing any order.

F98 Series

Resin-Molded Chip, High CV Undertab

QUALIFICATION TABLE

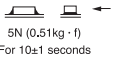
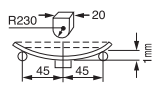
TEST	F98 series (Temperature range -55°C to +125°C)	
	Condition	
Damp Heat (Steady State)	At 40°C, 90 to 95% R.H., 500 hours (No voltage applied) Capacitance Change Refer to page 60 (*1) Dissipation Factor 150% or less of initial specified value Leakage Current 200% or less of initial specified value	
Temperature Cycles	-55°C / +125°C, 30 minutes each, 5 cycles Capacitance Change Refer to page 60 (*1) Dissipation Factor 150% or less of initial specified value Leakage Current 200% or less of initial specified value	
Resistance to Soldering Heat	10 seconds reflow at 260°C, 5 seconds immersion at 260°C. Capacitance Change Refer to page 60 (*1) Dissipation Factor Initial specified value or less Leakage Current Initial specified value or less	
Surge	After application of surge in series with a 1kΩ resistor at the rate of 30 seconds ON, 30 seconds OFF, for 1000 successive test cycles at 85°C, capacitors shall meet the characteristic requirements in the table above. (Not applied to LZT and AXE.) Capacitance Change Refer to page 60 (*1) Dissipation Factor 150% or less of initial specified value Leakage Current 200% or less of initial specified value	
Endurance	After 1000 hours' application of rated voltage in series with a 3Ω resistor at 85°C or +60°C, capacitors shall meet the characteristic requirements in the table above. Capacitance Change Refer to page 60 (*1) Dissipation Factor 150% or less of initial specified value Leakage Current 200% or less of initial specified value	
Shear Test	After applying the pressure load of 5N for 10±1 seconds horizontally to the center of capacitor side body which has no electrode and has been soldered beforehand on a substrate, there shall be found neither exfoliation nor its sign at the terminal electrode.	 5N (0.51kg · f) For 10±1 seconds
Terminal Strength	Keeping a capacitor surface-mounted on a substrate upside down and supporting the substrate at both of the opposite bottom points 45mm apart from the center of capacitor, the pressure strength is applied with a specified jig at the center of substrate so that the substrate may bend by 1mm as illustrated. Then, there shall be found no remarkable abnormality on the capacitor terminals.	

F98 Series

Resin-Molded Chip, High CV Undertab

AVX SOLID ELECTROLYTIC CAPACITOR ROADMAP

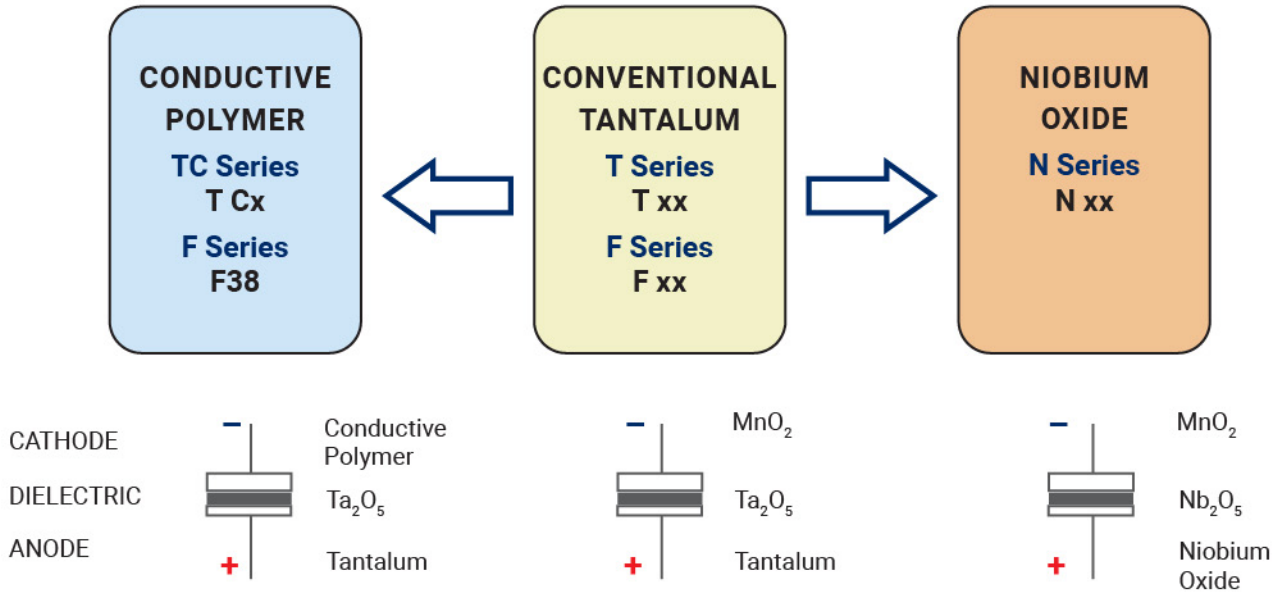

FIVE CAPACITOR CONSTRUCTION STYLES

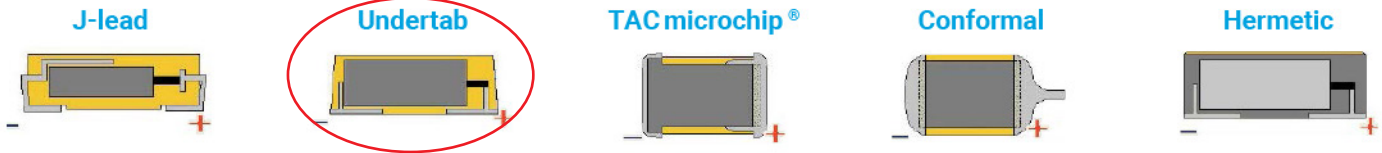

SERIES LINE UP : CONVENTIONAL SMD MnO₂

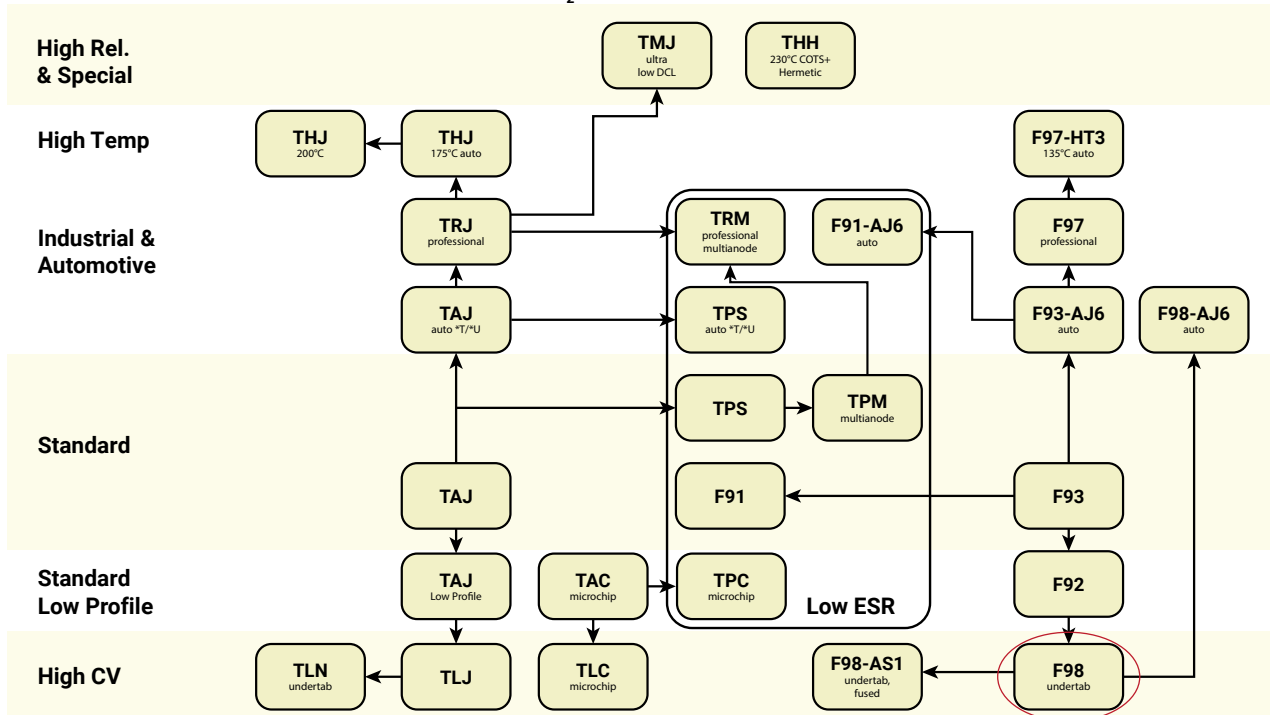

F98-AS1 Series

Fused Face-Down, High CV

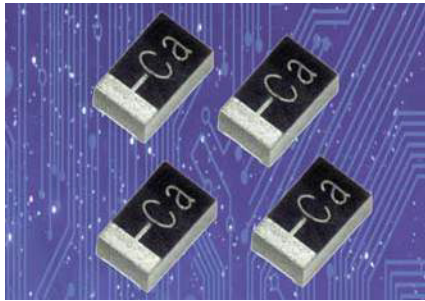

FEATURES

- Compliant to the RoHS3 directive 2015/863/EU
- SMD Face Down Design
- Small and Low Profile
- 100% Surge Current Tested



APPLICATIONS

- Smartphone
- Mobile Phone
- Wireless Module
- Hearing Aid

CASE DIMENSIONS:

millimeters (inches)

Code	EIA Code	EIA Metric	L	W ₁	W ₂	H	S ₁	S ₂
S	0805	2012-09	2.00 ^{+0.20} _{-0.10} (0.079 ^{+0.008} _{-0.004})	0.85 ^{+0.20} _{-0.10} (0.033 ^{+0.008} _{-0.004})	1.25±0.10 (0.049±0.004)	0.80±0.10 (0.031±0.004)	0.50±0.10 (0.020±0.004)	1.00±0.10 (0.039±0.004)

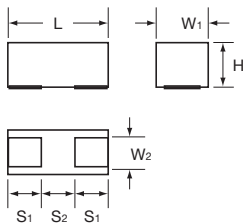

MARKING

S CASE

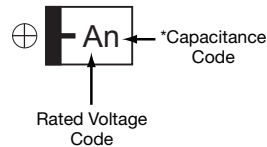

HOW TO ORDER

F98

Type

1A

Rated Voltage

336

Capacitance Code

pF code: 1st two digits represent significant figures, 3rd digit represents multiplier (number of zeros to follow)

M

Tolerance
M = ±20%

S

Case Size
See table above



Packaging

Reel Dia (φ180)	Tape Width (mm)
A	8

AS1

Fuse Series Code

TECHNICAL SPECIFICATIONS

Category Temperature Range:	-55 to +125°C
Rated Temperature:	+85°C
Capacitance Tolerance:	±20% at 120Hz
Dissipation Factor:	Refer to next page
ESR 100kHz:	Refer to next page
Leakage Current:	Refer to next page Provided that: After 5 minute's application of rated voltage, leakage current at 85°C 10 times or less than 20°C specified value. After 5 minute's application of rated voltage, leakage current at 125°C 12.5 times or less than 20°C specified value.
Termination Finish:	Gold Plating (standard)

F98-AS1 Series

Fused Face-Down, High CV

CAPACITANCE AND RATED VOLTAGE RANGE (LETTER DENOTES CASE SIZE)

Capacitance		Rated Voltage					*Cap Code
μF	Code	10V (1A)	16V (1C)	20V (1D)	25V (1E)	35 (1V)	
1.0	105					S	A
2.2	225						J
4.7	475						S
10	106		S				a
22	226	S					J
33	336	S					n
47	476	S					s

Released ratings

Please contact to your local AVX sales office when these series are being designed in your application.

RATINGS & PART NUMBER REFERENCE

AVX Part No.	Case Size	Capacitance (μF)	Rated Voltage (V)	DCL (μA)	DF @ 120Hz (%)	ESR @ 100kHz (Ω)	100kHz RMS Current (mA)			*1 ΔC/C (%)	MSL
							25°C	85°C	125°C		
10 Volt											
F981A226MSAAS1	S	22	10	2.2	20	4.5	100	90	40	±20	3
F981A336MSAAS1	S	33	10	3.3	30	6.5	83	75	33	±30	3
F981A476MSAAS1	S	47	10	9.4	35	5.5	90	81	36	±30	3
16 Volt											
F981C106MSAAS1	S	10	16	1.6	18	4.5	100	90	40	±20	3
35 Volt											
F981V105MSAAS1	S	1	35	0.7	20	8.5	73	65	29	±30	3

*2: Leakage Current

After 5 minute's application of rated voltage, leakage current at 20°C.

Moisture Sensitivity Level (MSL) is defined according to J-STD-020.

QUALIFICATION TABLE

TEST	F98-AS1 series (Temperature range -55°C to +125°C)	
	Condition	
Damp Heat (Steady State)	At 40°C, 90 to 95% R.H., 500 hours (No voltage applied) Capacitance Change Refer to the table above (*1) Dissipation Factor 150% or less of initial specified value Leakage Current 200% or less of initial specified value	
Temperature Cycles	-55°C / +125°C, 30 minutes each, 5 cycles Capacitance Change Refer to the table above (*1) Dissipation Factor 150% or less of initial specified value Leakage Current 200% or less of initial specified value	
Resistance to Soldering Heat	10 seconds reflow at 260°C, 5 seconds immersion at 260°C. Capacitance Change Refer to the table above (*1) Dissipation Factor Initial specified value or less Leakage Current Initial specified value or less	
Surge	After application of surge in series with a 1kΩ resistor at the rate of 30 seconds ON, 30 seconds OFF, for 1000 successive test cycles at 85°C, capacitors shall meet the characteristic requirements in the table above. Capacitance Change Refer the table above (*1) Dissipation Factor 150% or less of initial specified value Leakage Current 200% or less of initial specified value	
Endurance	After 1000 hours' application of rated voltage in series with a 3Ω resistor at 85°C, capacitors shall meet the characteristic requirements in the table above. Capacitance Change Refer to the table above (*1) Dissipation Factor 150% or less of initial specified value Leakage Current 200% or less of initial specified value	
Shear Test	After applying the pressure load of 5N for 10±1 seconds horizontally to the center of capacitor side body which has no electrode and has been soldered beforehand on a substrate, there shall be found neither exfoliation nor its sign at the terminal electrode.	
Terminal Strength	Keeping a capacitor surface-mounted on a substrate upside down and supporting the substrate at both of the opposite bottom points 45mm apart from the center of capacitor, the pressure strength is applied with a specified jig at the center of substrate so that the substrate may bend by 1mm as illustrated. Then, there shall be found no remarkable abnormality on the capacitor terminals.	
Fuse Activation	5 seconds max. with 2A min. applied current	

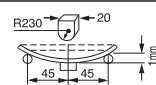
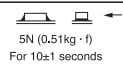

NOTICE: DESIGN, SPECIFICATIONS ARE SUBJECT TO CHANGE WITHOUT NOTICE.

F98-AS1 Series

Fused Face-Down, High CV

AVX SOLID ELECTROLYTIC CAPACITOR ROADMAP

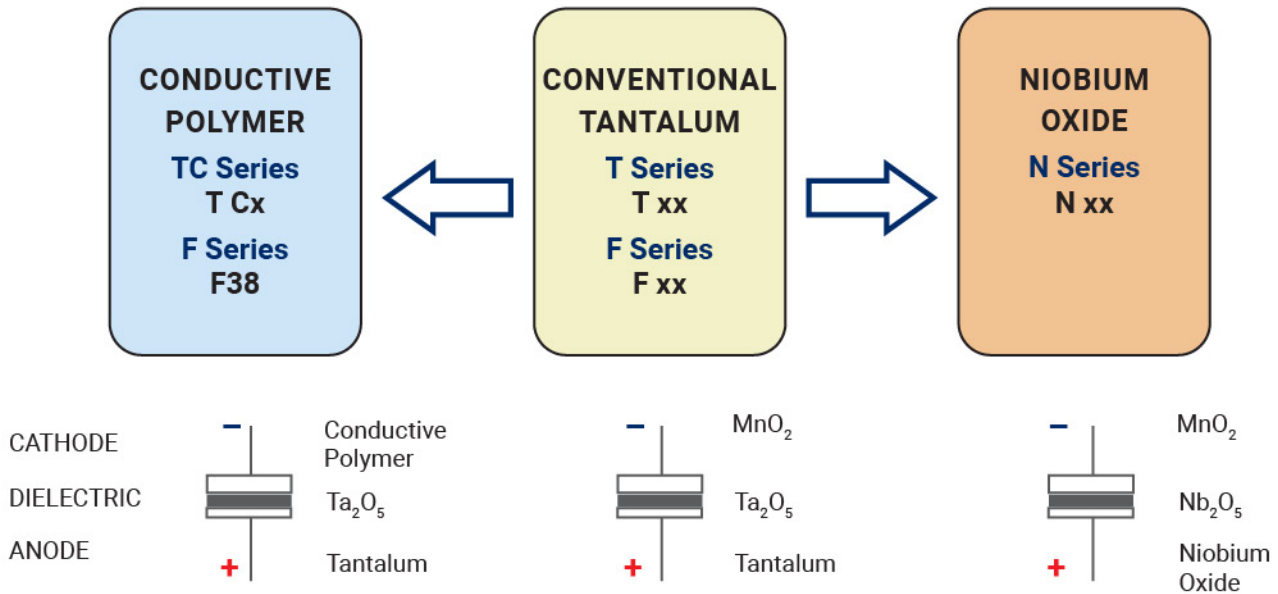

FIVE CAPACITOR CONSTRUCTION STYLES

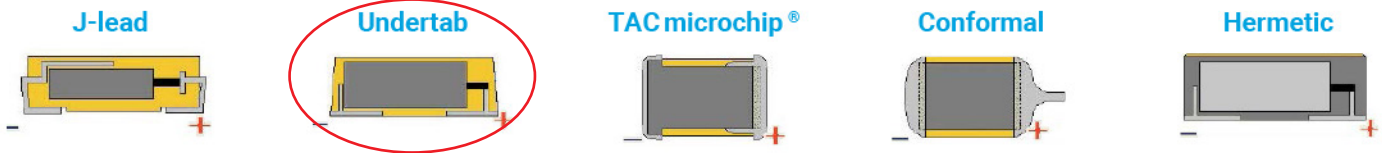

SERIES LINE UP: CONVENTIONAL SMD MnO₂

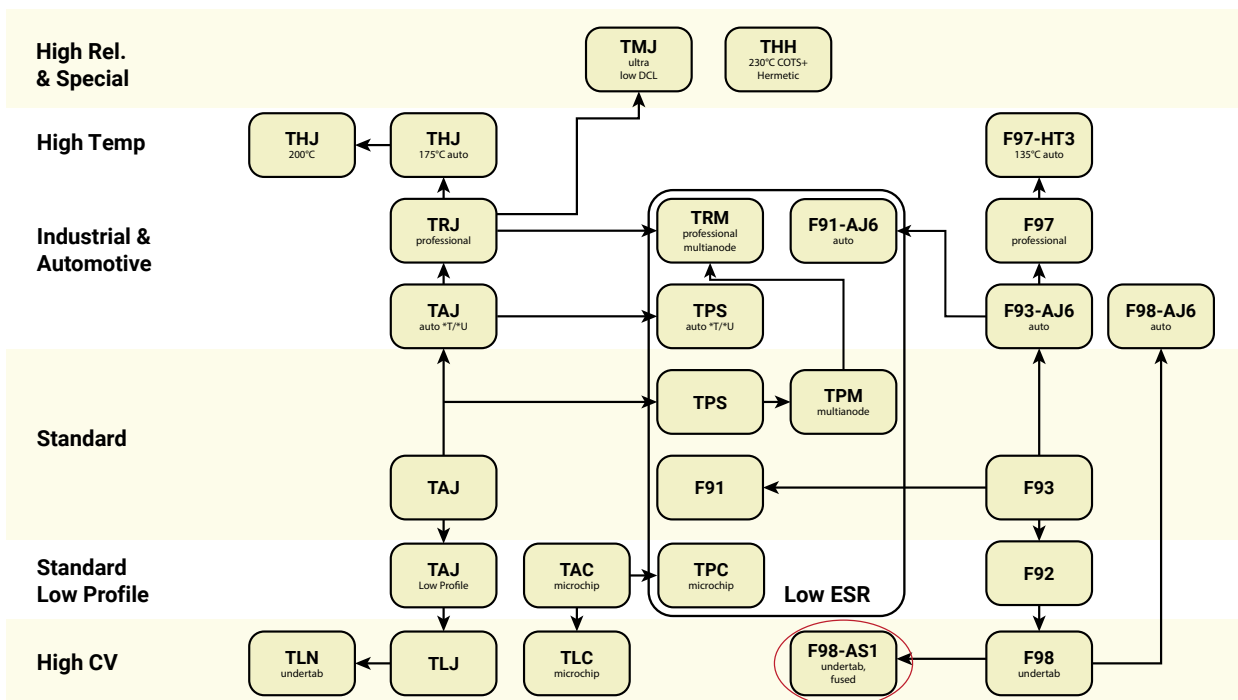

F98-AJ6 Series

Resin-Molded Chip, High CV Facedown - Automotive Range

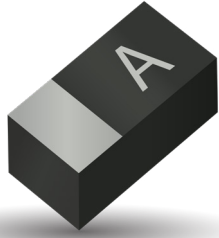

FEATURES

- Compliant to the RoHS3 directive 2015/863/EU
- SMD Face Down Design
- Small and Low Profile
- Compliant to AEC-Q200
- 100% Surge Current Tested



APPLICATIONS

- Infotainment
- Cabin Electronics
- Cameras
- Digital Millers

CASE DIMENSIONS:

millimeters (inches)

Code	EIA Code	EIA Metric	L	W ₁	W ₂	H	S ₁	S ₂
M	0603	1608-09	1.60 ^{+0.20} _{-0.10} (0.063 ^{+0.008} _{-0.004})	0.85 ^{+0.20} _{-0.10} (0.033 ^{+0.008} _{-0.004})	0.65±0.10 (0.026±0.004)	1.0 Max (0.039 Max)	0.50±0.10 (0.020±0.004)	0.60±0.10 (0.024±0.004)
S	0805	2012-09	2.00 ^{+0.20} _{-0.10} (0.079 ^{+0.008} _{-0.004})	1.25 ^{+0.20} _{-0.10} (0.049 ^{+0.008} _{-0.004})	0.90±0.10 (0.035±0.004)	0.80±0.10 (0.031±0.004)	0.50±0.10 (0.020±0.004)	1.00±0.10 (0.039±0.004)

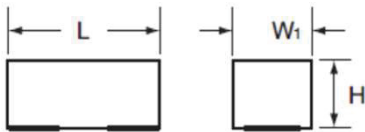

MARKING

M CASE

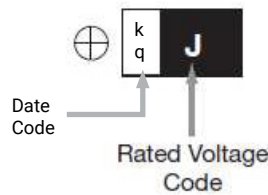

S CASE

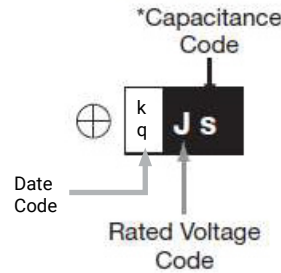

HOW TO ORDER

F98 T	1C T	106 T	M T	S T	 T	AJ6 T
Type	Rated Voltage	Capacitance Code pF code: 1st two digits represent significant figures, 3rd digit represents multiplier (number of zeros to follow)	Tolerance M = ± 20%	Case Size See table above	Packaging	AEC-Q200 Compliant

Code	Reel Dia (mm)	Tape Width (mm)	Qty (pcs)
A	φ180	8	4000
U	φ180	8	1000

TECHNICAL SPECIFICATIONS

Category Temperature Range:	-55 to +125°C
Rated Temperature:	+85°C
Capacitance Tolerance:	±20% at 120Hz
Dissipation Factor:	Refer to Ratings & Part Number Reference
ESR 100kHz:	Refer to Ratings & Part Number Reference
Leakage Current:	Refer to Ratings & Part Number Reference at 20°C after application of rated voltage for 5 minutes Provided that: After 5 minute's application of rated voltage, leakage current at 85°C 10 times or less than 20°C specified value. After 5 minute's application of rated voltage, leakage current at 125°C 12.5 times or less than 20°C specified value.
Termination Finish:	Gold Plating (standard)

F98-AJ6 Series

Resin-Molded Chip, High CV Facedown – Automotive Range

CAPACITANCE AND RATED VOLTAGE RANGE (LETTER DENOTES CASE SIZE)

Capacitance		Rated Voltage			Cap Code
μF	Code	6.3 (0J)	10V (1A)	16V (1C)	
4.7	475		M	M	S
10	106		M	S	a
22	226	M*	S*		J
33	336	M*			n
47	476	S*			s

Released Ratings

* Codes under development - subject to change

RATINGS & PART NUMBER REFERENCE

AVX Part Number	Case Size	Cap (μF)	Rated Voltage (V)	DCL Max (μA)	DF Max (%@120Hz)	ESR Max (Ω@100kHz)	100kHz RMS Current (mA)			ΔC/C	MSL
							25°C	85°C	125°C		
10 Volt											
F981A475MMAAJ6	M	4.7	10	0.5	12	6	65	58	26	±30	3
F981A106MMAAJ6	M	10	10	1.0	20	7.5	58	52	23	±30	3
16 Volt											
F981C475MMAAJ6	M	4.7	16	0.8	12	12	46	41	18	±30	3
F981C106MSAAJ6	S	10	16	1.6	18	4	106	95	42	±30	3

QUALIFICATION TABLE

Test	F98-AJ6 series (Temperature range -55°C to +125°C)	
	Condition	
Damp Heat (Steady State)	At 40°C, 90% R.H., 500 hours (No voltage applied) Capacitance Change.....Refer to Ratings & Part Number Reference Dissipation Factor.....150% or less of initial specified value Leakage Current.....200% or less of initial specified value	
Load Humidity	After 1000 hour's application of rated voltage in series with a 33Ω resistor at 85°C, 85% R.H., capacitors meet the characteristics requirements table below. Capacitance Change.....Refer to Ratings & Part Number Reference Dissipation Factor.....150% or less of initial specified value Leakage Current.....10 times or less of initial specified value	
Temperature Cycles	At -55°C / +125°C, 30 minutes each, 1000 cycles Capacitance Change.....Refer to Ratings & Part Number Reference Dissipation Factor.....150% or less initial specified value Leakage Current.....5 times or less of initial specified value	
Resistance to Soldering Heat	10 seconds reflow at 260°C, 5 seconds immersion at 260°C Capacitance Change.....Refer to Ratings & Part Number Reference Dissipation Factor.....Initial specified value or less Leakage Current.....Initial specified value or less	
Surge	After application of surge voltage in series with a 1kΩ resistor at the rate of 30 seconds ON, 30 seconds OFF, for 1000 successive test cycles at 85°C, capacitors shall meet the characteristic requirements in the table above. Capacitance Change.....Refer to Ratings & Part Number Reference Dissipation Factor.....150% or less of initial specified value Leakage Current.....200% or less of initial specified value	
Endurance	After 1000 hours' application of rated voltage in series with a 3Ω resistor at 85°C, or derated voltage in series with a 3Ω resistor at 125°C, capacitors shall meet the characteristic requirements in the table above. Capacitance Change.....Refer to Ratings & Part Number Reference Dissipation Factor.....150% or less of initial specified value Leakage Current.....200% or less of initial specified value	
Shear Test	After applying the pressure load of 5N for 60+1/-0 seconds horizontally to the center of capacitor side body which has no electrode and has been soldered beforehand on a substrate, there shall be found neither exfoliation nor its sign at the terminal electrode.	
Terminal Strength	Keeping a capacitor surface-mounted on a substrate upside down and supporting the substrate at both of the opposite bottom points 45mm apart from the center of capacitor, the pressure strength is applied with a specified jig at the center of substrate so that the substrate may bend by 1mm as illustrated. Then, there shall be found no remarkable abnormality on the capacitor terminals	

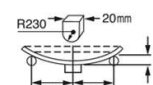

NOTICE: DESIGN, SPECIFICATIONS ARE SUBJECT TO CHANGE WITHOUT NOTICE.

F98-AJ6 Series

Resin-Molded Chip, High CV Facedown – Automotive Range

AVX SOLID ELECTROLYTIC CAPACITOR ROADMAP

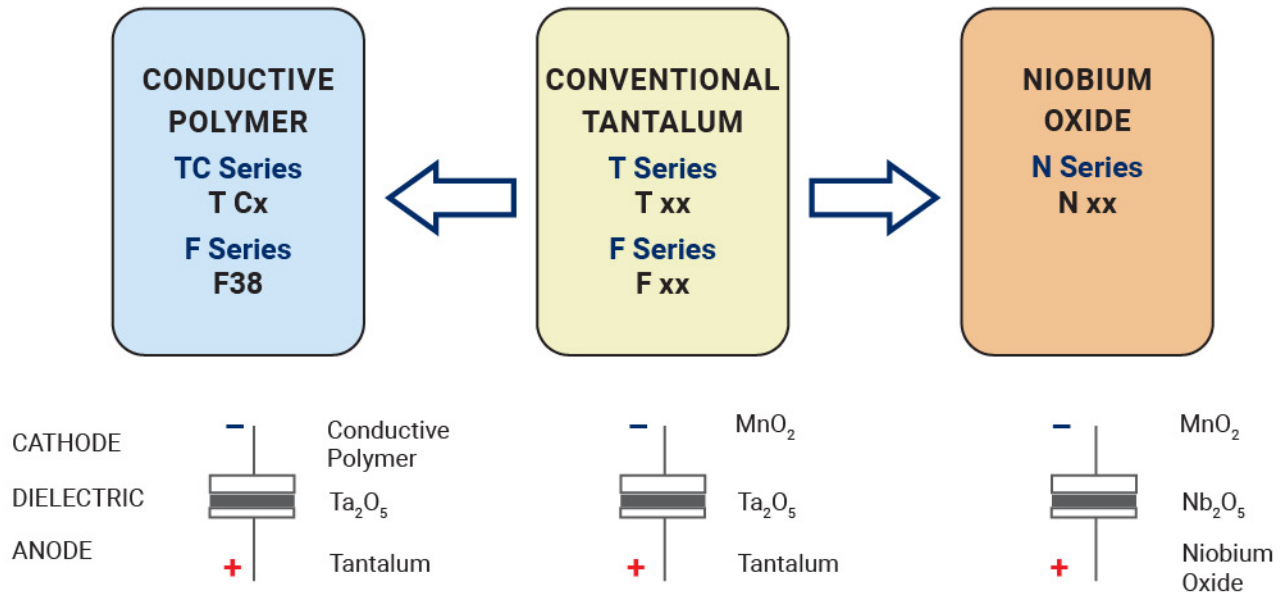

FIVE CAPACITOR CONSTRUCTION STYLES

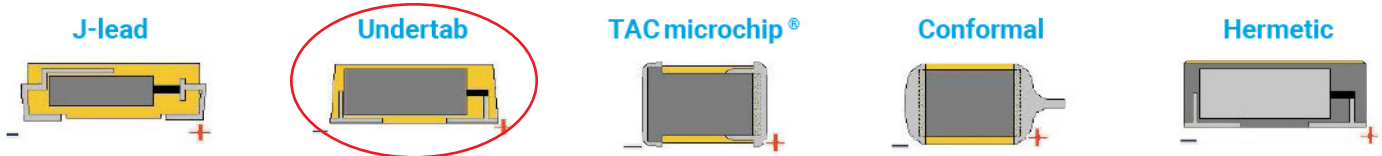

SERIES LINE UP : CONVENTIONAL SMD MnO₂

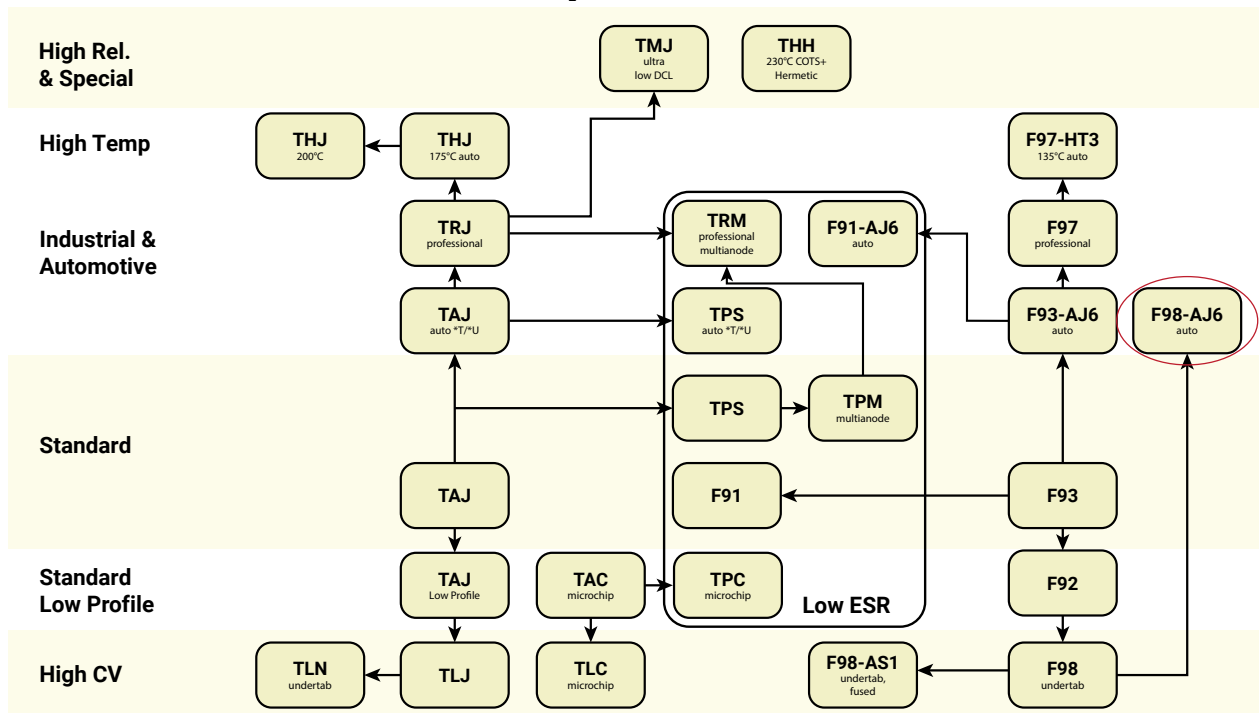

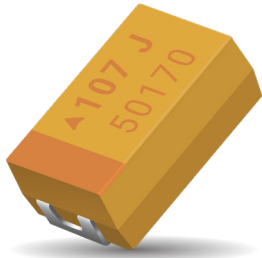

FEATURES

- Low ESR Series of Robust MnO₂ Solid Electrolyte Capacitors
- 100% Surge Current Tested
- CV Range: 0.15-1500µF / 2.5-50V
- 14 Case Sizes Available
- Power Supply Applications



SnPb termination option is not RoHS compliant.

APPLICATIONS

- General Medium Power DC/DC Convertors

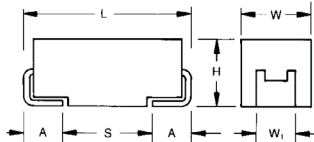

CASE DIMENSIONS:

millimeters (inches)

Code	EIA Code	EIA Metric	L±0.20 (0.008)	W+0.20 (0.008) -0.10 (0.004)	H+0.20 (0.008) -0.10 (0.004)	W ₁ ±0.20 (0.008)	A+0.30 (0.012) -0.20 (0.008)	S Min.
A	1206	3216-18	3.20 (0.126)	1.60 (0.063)	1.60 (0.063)	1.20 (0.047)	0.80 (0.031)	1.10 (0.043)
B	1210	3528-21	3.50 (0.138)	2.80 (0.110)	1.90 (0.075)	2.20 (0.087)	0.80 (0.031)	1.40 (0.055)
C	2312	6032-28	6.00 (0.236)	3.20 (0.126)	2.60 (0.102)	2.20 (0.087)	1.30 (0.051)	2.90 (0.114)
D	2917	7343-31	7.30 (0.287)	4.30 (0.169)	2.90 (0.114)	2.40 (0.094)	1.30 (0.051)	4.40 (0.173)
E	2917	7343-43	7.30 (0.287)	4.30 (0.169)	4.10 (0.162)	2.40 (0.094)	1.30 (0.051)	4.40 (0.173)
F	2312	6032-20	6.00 (0.236)	3.20 (0.126)	2.00 (0.079) max.	2.20 (0.087)	1.30 (0.051)	2.90 (0.114)
P	0805	2012-15	2.05 (0.081)	1.35 (0.053)	1.50 (0.059) max.	1.00 ±0.10 (0.039 ±0.004)	0.50 (0.020)	0.85 (0.033)
R	0805	2012-12	2.05 (0.081)	1.30 (0.051)	1.20 (0.047) max.	1.00 ±0.10 (0.039 ±0.004)	0.50 (0.020)	0.85 (0.033)
S	1206	3216-12	3.20 (0.126)	1.60 (0.063)	1.20 (0.047) max.	1.20 (0.047)	0.80 (0.031)	1.10 (0.043)
T	1210	3528-12	3.50 (0.138)	2.80 (0.110)	1.20 (0.047) max.	2.20 (0.087)	0.80 (0.031)	1.40 (0.055)
V	2924	7361-38	7.30 (0.287)	6.10 (0.240)	3.55 (0.140)	3.10 (0.122)	1.30 (0.051)	4.40 (0.173)
W	2312	6032-15	6.00 (0.236)	3.20 (0.126)	1.50 (0.059) max.	2.20 (0.087)	1.30 (0.051)	2.90 (0.114)
X	2917	7343-15	7.30 (0.287)	4.30 (0.169)	1.50 (0.059) max.	2.40 (0.094)	1.30 (0.051)	4.40 (0.173)
Y	2917	7343-20	7.30 (0.287)	4.30 (0.169)	2.00 (0.079) max.	2.40 (0.094)	1.30 (0.051)	4.40 (0.173)

W₁ dimension applies to the termination width for A dimensional area only.

MARKING

A, B, C, D, E, F, S, T, V, W, X, Y CASE

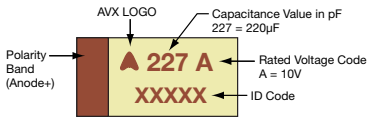

P, R CASE

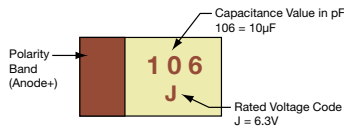

HOW TO ORDER

TPS	C	107	M	010	R	0100	-
Type	Case Size See table above	Capacitance Code pF code: 1st two digits represent significant figures, 3rd digit represents multiplier (number of zeros to follow)	Tolerance K = ±10% M = ±20%	Rated DC Voltage 002 = 2.5Vdc 004 = 4Vdc 006 = 6.3Vdc 010 = 10Vdc 016 = 16Vdc 020 = 20Vdc 025 = 25Vdc 035 = 35Vdc 050 = 50Vdc	Packaging R = Pure Tin 7" Reel S = Pure Tin 13" Reel A = Gold Plating 7" Reel B = Gold Plating 13" Reel H = Tin Lead 7" Reel (Contact Manufacturer) K = Tin Lead 13" Reel (Contact Manufacturer) H, K = Non RoHS	ESR in mΩ	Additional characters may be added for special requirements V = Dry pack Option (selected ratings only)

TECHNICAL SPECIFICATIONS

Technical Data:	All technical data relate to an ambient temperature of +25°C									
Capacitance Range:	0.15 µF to 1500 µF									
Capacitance Tolerance:	±10%; ±20%									
Rated Voltage (V _R)	≤ +85°C:	2.5	4	6.3	10	16	20	25	35	50
Category Voltage (V _C)	≤ +125°C:	1.7	2.7	4	7	10	13	17	23	33
Surge Voltage (V _S)	≤ +85°C:	3.3	5.2	8	13	20	26	32	46	65
Surge Voltage (V _S)	≤ +125°C:	2.2	3.4	5	8	13	16	20	28	40
Temperature Range:	-55°C to +125°C									
Environmental Classification:	55/125/56 (IEC 68-2)									
Reliability:	1% per 1000 hours at 85°C, V _R with 0.1Ω/V series impedance, 60% confidence level									
Termination Finished:	Sn Plating (standard), Gold and SnPb Plating upon request									
	For AEC-Q200 availability, please contact AVX									

CAPACITANCE AND RATED VOLTAGE RANGE (LETTER DENOTES CASE SIZE)

Capacitance		Rated Voltage DC (V _r) to 85°C								
μF	Code	2.5V (e)	4V (G)	6.3V (J)	10V (A)	16V (C)	20V (D)	25V (E)	35V (V)	50V (T)
0.15	154									A(9000)
0.22	224								A(6000)	A(7000)
0.33	334								A(6000)	A(7000)
0.47	474							A(7000)	A(6000) B(4000)	A(6500), B(6000) C(2300)
0.68	684							A(6000)	A(6000)	B(4000)
1.0	105				R(9000)	A(6200)	A(3000), R(6000) S(6000), T(2000)	A(4000) R(2500,4000)	A(3000) B(2000)	B(3000) C(2500)
1.5	155						A(3000)	A(3000) B(1800)	A(3000) B(2500)	C(1500,2000)
2.2	225			R(7000)	A(1800)	A(1800,3500) T(2000)	A(3000) B(1700)	A(2500) B(900,1200,2500)	B(750,1500, 2000) C(1000)	C(1500) D(1200)
3.3	335			A(2100)	T(1500)	A(3500) B(2500)	A(2500) B(1300)	A(1000,1500) B(750,1500,2000)	B(1000) C(700)	C(1000) D(800)
4.7	475			S(4000)	A(1400), B(1400) R(3000,5000)	A(2000) B(800,1500)	A(1800) B(750,1000)	B(700,900,1500) C(700)	B(700,1500) C(600), D(700)	C(800) D(250,300,500,700) X(500)
6.8	685			A(1800)	A(1800), B(1300) T(1800)	A(1500) B(600,1200)	A(1000) B(600,1000) C(700)	B(700) C(500,600,700)	C(350) D(150,400,500)	D(200,300, 500,600)
10	106		R(3000)	A(1500), B(1500) R(1000,1500,3000) T(1000)	A(900,1800), B(1000) P(2000) ^(M) , S(900) T(1000,2000)	A(1000), B(500,800) C(500), T(800,1000) W(500,600)	B(500,1000) C(500,700) W(250, 500)	B(1800) C(300,500) D(500)	C(600) D(125,300) E(100,150,200)Y(250)	D(500) E(250,300,400,500)
15	156			A(700,1500)	A(1000) B(450,600), C(700) T(1200)	B(500,800) C(300,700)	B(500) C(400,450)	C(220,300) D(100,300)	C(350,450) D(100,300) Y(250)	E(250) V(250)
22	226			A(300,500,900) B(375,600) C(500), S(900)	A(900) B(400,500,700) C(300), T(800)	B(400,600) C(150,250,300,375) D(700), W(500)	B(400,600) C(100,150,400) D(200,300)	C(275,400) D(100,200,300) F(300)	D(125,200,300,400) E(125,200,300) Y(200)	
33	336			A(600) B(250,350,450,600) T(800)	A(700) B(250,425,500,650) C(150,375,500) W(350)	B(350,500) C(100,150,225,300) D(200), W(140,175, 250,400,500) Y(300,400)	C(300) D(100,200)	C(400) D(100,200,300) E(100,175,200,300) F(150,200,400) Y(200)	D(200,300) E(100,250,300) V(200)	
47	476		A(500)	A(800) B(250,350,500) C(300), T(1200)	B(250,350,500,650) C(200,350) D(100,300) W(125,150,250)	C(110,350) D(80,100,150,200) W(200) X(180), Y(250)	D(75,100,200) E(70,125,150, 200,250), X(200)	D(125,150,250 E(80,100,125) Y(250)	D(300), E(200,250) V(150,200)	
68	686			B(250,350,500) C(150,200) W(110,125,250)	B(600) C(80,100,200,300) D(100,150) W(100,150) Y(100,200)	C(125,200) D(70,100,150) F(200), X(150) Y(150,200,250)	D(70,150, 200,300) E(125,150,200) Y(200)	D(150,200,300) E(125,200) V(80,95,150,200)	V(150,200)	
100	107	B(200)	B(200,250, 350,500) T(500) ^(M) W(100)	B(250,400) C(75,150), D(300) W(100,150), Y(100)	B(400) C(75,100,150,200) D(50,65,80,100,125, 150), E(125), W(150) X(85,150,200) Y(100,150,200)	C(200) D(60,100,125,150) E(55,100,125,150) F(150,200) ^(M) Y(100,150,200)	D(85,100,150) E(100,150,200) V(60,85,100,200)	E(150), V(100)		
150	157	B(150)	B(250) C(70,80)	C(50,90,150,200,250) D(50,125) Y(40,50)	C(150), D(50,85,100) E(100), F(200) X(100) ^(M) Y(100,150,200)	D(60,85,100,125,150) E(50,100), V(45,75) Y(200) ^(M)	V(80)	V(150) ^(M)		
220	227	B(150, 200,600) D(45)	D(40,50,100) Y(40,50,75)	C(70,100,125,250) D(50,100,125) E(100), F(200) Y(100,150)	D(40,50,100,150) E(50,60,70,100, 125,150) Y(100,150,200)	D(200) ^(M) E(50,100,150) V(50,75,100,150)				
330	337	Y(40)	C(100) D(35,45,100) F(200) X(100)	C(80,100) D(45,50,70,100) E(50,100,125,150) V(100), Y(75,100,150)	D(50,65,100,150) E(40,50,60,100) V(40,60,100)	E(200) ^(M)				
470	477	D(35) F(200) Y(100)	D(45,100) E(35,45,100)	D(45,60,100,200) E(45,50,60,100,200) V(40,55,100), Y(150)	E(45,50,60,100,200) V(40,60,100)					
680	687	D(35,50) E(35,50) Y(100)	D(45,60,100) E(40,60,100)	E(45,60,100) V(35,40,50)	E(150) ^(M) V(100) ^(M)					
1000	108	E(30,40) Y(100) ^(M)	E(40,60) V(25,35,40,50)	E(100) ^(M) , V(40,50) ^(M)						
1500	158	D(100) E(50) V(30,40) ^(M)	E(50,75) V(50,75) ^(M)							

Note for designers - for the highlighted ratings, higher voltage options are now available in the same case size and are recommended for new designs.

Released ratings^(M tolerance only) (ESR ratings in mOhms in parentheses)

NOTE: Voltage ratings are minimum values. AVX reserves the right to supply higher voltage ratings in the same case size, to the same reliability standards.

RATINGS & PART NUMBER REFERENCE

AVX Part No.	Case Size	Capacitance (µF)	Rated Voltage (V)	Rated Temperature (°C)	Category Voltage (V)	Category Temperature (°C)	DCL Max. (µA)	DF Max. (%)	ESR Max. @ 100kHz (mΩ)	100kHz RMS Current (A)			MSL
										25°C	85°C	125°C	
2.5 Volt @ 85°C													
TPSB107*002#0200	B	100	2.5	85	1.7	125	2.5	8	200	0.652	0.587	0.261	1
TPSB157*002#0150	B	150	2.5	85	1.7	125	3	10	150	0.753	0.677	0.301	1
TPSB227*002#0150	B	220	2.5	85	1.7	125	4.4	16	150	0.753	0.677	0.301	1
TPSB227*002#0200	B	220	2.5	85	1.7	125	4.4	16	200	0.652	0.587	0.261	1
TPSB227*002#0600	B	220	2.5	85	1.7	125	4.4	16	600	0.376	0.339	0.151	1
TPSD227*002#0045	D	220	2.5	85	1.7	125	5.5	8	45	1.826	1.643	0.730	1
TPSY337*002#0040	Y	330	2.5	85	1.7	125	8.2	8	40	1.768	1.591	0.707	1 ¹⁾
TPSD477*002#0035	D	470	2.5	85	1.7	125	11.6	8	35	2.070	1.863	0.828	1
TPSF477*002#0200	F	470	2.5	85	1.7	125	11.8	12	200	0.707	0.636	0.283	1
TPSY477*002#0100	Y	470	2.5	85	1.7	125	11	12	100	1.118	1.006	0.447	1 ¹⁾
TPSD687*002#0035	D	680	2.5	85	1.7	125	17	16	35	2.070	1.863	0.828	1
TPSD687*002#0050	D	680	2.5	85	1.7	125	17	16	50	1.732	1.559	0.693	1
TPSE687*002#0035	E	680	2.5	85	1.7	125	17	10	35	2.171	1.954	0.868	1 ¹⁾
TPSE687*002#0050	E	680	2.5	85	1.7	125	17	10	50	1.817	1.635	0.727	1 ¹⁾
TPSY687*002#0100	Y	680	2.5	85	1.7	125	17	12	100	1.118	1.006	0.447	1 ¹⁾
TPSE108*002#0030	E	1000	2.5	85	1.7	125	25	14	30	2.345	2.111	0.938	1 ¹⁾
TPSE108*002#0040	E	1000	2.5	85	1.7	125	25	14	40	2.031	1.828	0.812	1 ¹⁾
TPSY108M002#0100	Y	1000	2.5	85	1.7	125	25	30	100	1.118	1.006	0.447	1 ¹⁾
TPSD158*002#0100	D	1500	2.5	85	1.7	125	37.5	60	100	1.125	1.102	0.490	1
TPSE158*002#0050	E	1500	2.5	85	1.7	125	37.5	20	50	1.817	1.635	0.727	1 ¹⁾
TPSV158M002#0030	V	1500	2.5	85	1.7	125	30	20	30	2.887	2.598	1.155	1 ¹⁾
TPSV158M002#0040	V	1500	2.5	85	1.7	125	30	20	40	2.500	2.250	1.000	1 ¹⁾
4 Volt @ 85°C													
TPSR106*004#3000	R	10	4	85	2.7	125	0.5	6	3000	0.135	0.122	0.054	1
TPSA476*004#0500	A	47	4	85	2.7	125	1.9	8	500	0.387	0.349	0.155	1
TPSB107*004#0200	B	100	4	85	2.7	125	4	8	200	0.652	0.587	0.261	1
TPSB107*004#0250	B	100	4	85	2.7	125	4	8	250	0.583	0.525	0.233	1
TPSB107*004#0350	B	100	4	85	2.7	125	4	8	350	0.493	0.444	0.197	1
TPSB107*004#0500	B	100	4	85	2.7	125	4	8	500	0.412	0.371	0.165	1
TPST107M004#0500	T	100	4	85	2.7	125	4	14	500	0.400	0.360	0.160	1
TPSW107*004#0100	W	100	4	85	2.7	125	4	6	100	0.949	0.854	0.379	1
TPSB157*004#0250	B	150	4	85	2.7	125	6	10	250	0.583	0.525	0.233	1
TPSC157*004#0070	C	150	4	85	2.7	125	6	6	70	1.254	1.128	0.501	1
TPSC157*004#0080	C	150	4	85	2.7	125	6	6	80	1.173	1.055	0.469	1
TPSD227*004#0040	D	220	4	85	2.7	125	8.8	8	40	1.936	1.743	0.775	1
TPSD227*004#0050	D	220	4	85	2.7	125	8.8	8	50	1.732	1.559	0.693	1
TPSD227*004#0100	D	220	4	85	2.7	125	8.8	8	100	1.225	1.102	0.490	1
TPSY227*004#0040	Y	220	4	85	2.7	125	8.8	8	40	1.768	1.591	0.707	1 ¹⁾
TPSY227*004#0050	Y	220	4	85	2.7	125	8.8	8	50	1.581	1.423	0.632	1 ¹⁾
TPSY227*004#0075	Y	220	4	85	2.7	125	8.8	8	75	1.291	1.162	0.516	1 ¹⁾
TPSC337*004#0100	C	330	4	85	2.7	125	13.2	8	100	1.049	0.944	0.420	1
TPSD337*004#0035	D	330	4	85	2.7	125	13.2	8	35	2.070	1.863	0.828	1
TPSD337*004#0045	D	330	4	85	2.7	125	13.2	8	45	1.826	1.643	0.730	1
TPSD337*004#0100	D	330	4	85	2.7	125	13.2	8	100	1.225	1.102	0.490	1
TPSF337*004#0200	F	330	4	85	2.7	125	13.2	10	200	0.707	0.636	0.283	1
TPSX337*004#0100	X	330	4	85	2.7	125	13.2	8	100	1.000	0.900	0.400	1 ¹⁾
TPSD477*004#0045	D	470	4	85	2.7	125	18.8	12	45	1.826	1.643	0.730	1
TPSD477*004#0100	D	470	4	85	2.7	125	18.8	12	100	1.225	1.102	0.490	1
TPSE477*004#0035	E	470	4	85	2.7	125	18.8	10	35	2.171	1.954	0.868	1 ¹⁾
TPSE477*004#0045	E	470	4	85	2.7	125	18.8	10	45	1.915	1.723	0.766	1 ¹⁾
TPSE477*004#0100	E	470	4	85	2.7	125	18.8	10	100	1.285	1.156	0.514	1 ¹⁾
TPSD687*004#0045	D	680	4	85	2.7	125	27.2	14	45	1.826	1.643	0.730	1
TPSD687*004#0060	D	680	4	85	2.7	125	27.2	14	60	1.581	1.423	0.632	1
TPSD687*004#0100	D	680	4	85	2.7	125	27.2	14	100	1.225	1.102	0.490	1
TPSE687*004#0040	E	680	4	85	2.7	125	27.2	10	40	2.031	1.828	0.812	1 ¹⁾
TPSE687*004#0060	E	680	4	85	2.7	125	27.2	10	60	1.658	1.492	0.663	1 ¹⁾
TPSE687*004#0100	E	680	4	85	2.7	125	27.2	10	100	1.285	1.156	0.514	1 ¹⁾
TPSE108*004#0040	E	1000	4	85	2.7	125	40	14	40	2.031	1.828	0.812	1 ¹⁾
TPSE108*004#0060	E	1000	4	85	2.7	125	40	14	60	1.658	1.492	0.663	1 ¹⁾
TPSV108*004#0025	V	1000	4	85	2.7	125	40	16	25	3.162	2.846	1.265	1 ¹⁾
TPSV108*004#0035	V	1000	4	85	2.7	125	40	16	35	2.673	2.405	1.069	1 ¹⁾
TPSV108*004#0040	V	1000	4	85	2.7	125	40	16	40	2.500	2.250	1.000	1 ¹⁾
TPSV108*004#0050	V	1000	4	85	2.7	125	40	16	50	2.236	2.012	0.894	1 ¹⁾
TPSE158*004#0050	E	1500	4	85	2.7	125	60	30	50	1.817	1.635	0.727	1 ¹⁾
TPSE158*004#0075	E	1500	4	85	2.7	125	60	30	75	1.483	1.335	0.593	1 ¹⁾
TPSV158M004#0050	V	1500	4	85	2.7	125	60	30	50	2.236	2.012	0.894	1 ¹⁾
TPSV158M004#0075	V	1500	4	85	2.7	125	60	30	75	1.826	1.643	0.730	1 ¹⁾
6.3 Volt @ 85°C													
TPSR225*006#7000	R	2.2	6.3	85	4	125	0.5	6	7000	0.089	0.080	0.035	1
TPSA335*006#2100	A	3.3	6.3	85	4	125	0.5	6	2100	0.189	0.170	0.076	1
TPSS475*006#4000	S	4.7	6.3	85	4	125	0.5	6	4000	0.127	0.115	0.051	1

RATINGS & PART NUMBER REFERENCE

AVX Part No.	Case Size	Capacitance (µF)	Rated Voltage (V)	Rated Temperature (°C)	Category Voltage (V)	Category Temperature (°C)	DCL Max. (µA)	DF Max. (%)	ESR Max. @ 100kHz (mΩ)	100kHz RMS Current (A)			MSL
										25°C	85°C	125°C	
TPSA685*006#1800	A	6.8	6.3	85	4	125	0.5	6	1800	0.204	0.184	0.082	1
TPSA106*006#1500	A	10	6.3	85	4	125	0.6	6	1500	0.224	0.201	0.089	1
TPSB106*006#1500	B	10	6.3	85	4	125	0.6	6	1500	0.238	0.214	0.095	1
TPSR106*006#1000	R	10	6.3	85	4	125	0.6	8	1000	0.235	0.211	0.094	1
TPSR106*006#1500	R	10	6.3	85	4	125	0.6	8	1500	0.191	0.172	0.077	1
TPSR106*006#3000	R	10	6.3	85	4	125	0.6	8	3000	0.135	0.122	0.054	1
TPST106*006#1000	T	10	6.3	85	4	125	0.6	6	1000	0.283	0.255	0.113	1
TPSA156*006#0700	A	15	6.3	85	4	125	0.9	6	700	0.327	0.295	0.131	1
TPSA156*006#1500	A	15	6.3	85	4	125	0.9	6	1500	0.224	0.201	0.089	1
TPSA226*006#0300	A	22	6.3	85	4	125	1.4	6	300	0.500	0.450	0.200	1
TPSA226*006#0500	A	22	6.3	85	4	125	1.4	6	500	0.387	0.349	0.155	1
TPSA226*006#0900	A	22	6.3	85	4	125	1.4	6	900	0.289	0.260	0.115	1
TPSB226*006#0375	B	22	6.3	85	4	125	1.4	6	375	0.476	0.428	0.190	1
TPSB226*006#0600	B	22	6.3	85	4	125	1.4	6	600	0.376	0.339	0.151	1
TPSC226*006#0500	C	22	6.3	85	4	125	1.4	6	500	0.469	0.422	0.188	1
TPSS226*006#0900	S	22	6.3	85	4	125	1.3	10	900	0.269	0.242	0.107	1
TPSA336*006#0600	A	33	6.3	85	4	125	2.1	8	600	0.354	0.318	0.141	1
TPSB336*006#0250	B	33	6.3	85	4	125	2.1	6	250	0.583	0.525	0.233	1
TPSB336*006#0350	B	33	6.3	85	4	125	2.1	6	350	0.493	0.444	0.197	1
TPSB336*006#0450	B	33	6.3	85	4	125	2.1	6	450	0.435	0.391	0.174	1
TPSB336*006#0600	B	33	6.3	85	4	125	2.1	6	600	0.376	0.339	0.151	1
TPST336*006#0800	T	33	6.3	85	4	125	2.1	10	800	0.316	0.285	0.126	1
TPSA476*006#0800	A	47	6.3	85	4	125	2.8	10	800	0.306	0.276	0.122	1
TPSB476*006#0250	B	47	6.3	85	4	125	3	6	250	0.583	0.525	0.233	1
TPSB476*006#0350	B	47	6.3	85	4	125	3	6	350	0.493	0.444	0.197	1
TPSB476*006#0500	B	47	6.3	85	4	125	3	6	500	0.412	0.371	0.165	1
TPSC476*006#0300	C	47	6.3	85	4	125	3	6	300	0.606	0.545	0.242	1
TPST476*006#1200	T	47	6.3	85	4	125	2.8	10	1200	0.258	0.232	0.103	1
TPSB686*006#0250	B	68	6.3	85	4	125	4	8	250	0.583	0.525	0.233	1
TPSB686*006#0350	B	68	6.3	85	4	125	4	8	350	0.493	0.444	0.197	1
TPSB686*006#0500	B	68	6.3	85	4	125	4	8	500	0.412	0.371	0.165	1
TPSC686*006#0150	C	68	6.3	85	4	125	4.3	6	150	0.856	0.771	0.343	1
TPSC686*006#0200	C	68	6.3	85	4	125	4.3	6	200	0.742	0.667	0.297	1
TPSW686*006#0110	W	68	6.3	85	4	125	4.3	6	110	0.905	0.814	0.362	1
TPSW686*006#0125	W	68	6.3	85	4	125	4.3	6	125	0.849	0.764	0.339	1
TPSW686*006#0250	W	68	6.3	85	4	125	4.3	6	250	0.600	0.540	0.240	1
TPSB107*006#0250	B	100	6.3	85	4	125	6.3	10	250	0.583	0.525	0.233	1
TPSB107*006#0400	B	100	6.3	85	4	125	6.3	10	400	0.461	0.415	0.184	1
TPSC107*006#0075	C	100	6.3	85	4	125	6.3	6	75	1.211	1.090	0.484	1
TPSC107*006#0150	C	100	6.3	85	4	125	6.3	6	150	0.856	0.771	0.343	1
TPSD107*006#0300	D	100	6.3	85	4	125	6.3	6	300	0.707	0.636	0.283	1
TPSW107*006#0100	W	100	6.3	85	4	125	6.3	6	100	0.949	0.854	0.379	1
TPSW107*006#0150	W	100	6.3	85	4	125	6.3	6	150	0.775	0.697	0.310	1
TPSY107*006#0100	Y	100	6.3	85	4	125	6.3	6	100	1.118	1.006	0.447	1 ¹⁾
TPSC157*006#0050	C	150	6.3	85	4	125	9.5	6	50	1.483	1.335	0.593	1
TPSC157*006#0090	C	150	6.3	85	4	125	9.5	6	90	1.106	0.995	0.442	1
TPSC157*006#0150	C	150	6.3	85	4	125	9.5	6	150	0.856	0.771	0.343	1
TPSC157*006#0200	C	150	6.3	85	4	125	9.5	6	200	0.742	0.667	0.297	1
TPSC157*006#0250	C	150	6.3	85	4	125	9.5	6	250	0.663	0.597	0.265	1
TPSD157*006#0050	D	150	6.3	85	4	125	9.5	6	50	1.732	1.559	0.693	1
TPSD157*006#0125	D	150	6.3	85	4	125	9.5	6	125	1.095	0.986	0.438	1
TPSY157*006#0040	Y	150	6.3	85	4	125	9.5	6	40	1.768	1.591	0.707	1 ¹⁾
TPSY157*006#0050	Y	150	6.3	85	4	125	9.5	6	50	1.581	1.423	0.632	1 ¹⁾
TPSC227*006#0070	C	220	6.3	85	4	125	13.9	8	70	1.254	1.128	0.501	1
TPSC227*006#0100	C	220	6.3	85	4	125	13.9	8	100	1.049	0.944	0.420	1
TPSC227*006#0125	C	220	6.3	85	4	125	13.9	8	125	0.938	0.844	0.375	1
TPSC227*006#0250	C	220	6.3	85	4	125	13.9	8	250	0.663	0.597	0.265	1
TPSD227*006#0050	D	220	6.3	85	4	125	13.9	8	50	1.732	1.559	0.693	1
TPSD227*006#0100	D	220	6.3	85	4	125	13.9	8	100	1.225	1.102	0.490	1
TPSD227*006#0125	D	220	6.3	85	4	125	13.9	8	125	1.095	0.986	0.438	1
TPSE227*006#0100	E	220	6.3	85	4	125	13.9	8	100	1.285	1.156	0.514	1 ¹⁾
TPSF227*006#0200	F	220	6.3	85	4	125	13.2	10	200	0.707	0.636	0.283	1
TPSY227*006#0100	Y	220	6.3	85	4	125	13.9	8	100	1.118	1.006	0.447	1 ¹⁾
TPSY227*006#0150	Y	220	6.3	85	4	125	13.9	8	150	0.913	0.822	0.365	1 ¹⁾
TPSC337*006#0080	C	330	6.3	85	4	125	19.8	12	80	1.173	1.055	0.469	1
TPSC337*006#0100	C	330	6.3	85	4	125	19.8	12	100	1.049	0.944	0.420	1
TPSD337*006#0045	D	330	6.3	85	4	125	20.8	8	45	1.826	1.643	0.730	1
TPSD337*006#0050	D	330	6.3	85	4	125	20.8	8	50	1.732	1.559	0.693	1
TPSD337*006#0070	D	330	6.3	85	4	125	20.8	8	70	1.464	1.317	0.586	1
TPSD337*006#0100	D	330	6.3	85	4	125	20.8	8	100	1.225	1.102	0.490	1
TPSE337*006#0050	E	330	6.3	85	4	125	20.8	8	50	1.817	1.635	0.727	1 ¹⁾

RATINGS & PART NUMBER REFERENCE

AVX Part No.	Case Size	Capacitance (µF)	Rated Voltage (V)	Rated Temperature (°C)	Category Voltage (V)	Category Temperature (°C)	DCL Max. (µA)	DF Max. (%)	ESR Max. @ 100kHz (mΩ)	100kHz RMS Current (A)			MSL
										25°C	85°C	125°C	
TPSE337*006#0100	E	330	6.3	85	4	125	20.8	8	100	1.285	1.156	0.514	1 ¹⁾
TPSE337*006#0125	E	330	6.3	85	4	125	20.8	8	125	1.149	1.034	0.460	1 ¹⁾
TPSE337*006#0150	E	330	6.3	85	4	125	20.8	8	150	1.049	0.944	0.420	1 ¹⁾
TPSV337*006#0100	V	330	6.3	85	4	125	20.8	8	100	1.581	1.423	0.632	1 ¹⁾
TPSY337*006#0075	Y	330	6.3	85	4	125	20.8	12	75	1.291	1.162	0.516	1 ¹⁾
TPSY337*006#0100	Y	330	6.3	85	4	125	20.8	12	100	1.118	1.006	0.447	1 ¹⁾
TPSY337*006#0150	Y	330	6.3	85	4	125	20.8	12	150	0.913	0.822	0.365	1 ¹⁾
TPSD477*006#0045	D	470	6.3	85	4	125	28	12	45	1.826	1.643	0.730	1
TPSD477*006#0060	D	470	6.3	85	4	125	28	12	60	1.581	1.423	0.632	1
TPSD477*006#0100	D	470	6.3	85	4	125	28	12	100	1.225	1.102	0.490	1
TPSD477*006#0200	D	470	6.3	85	4	125	28	12	200	0.866	0.779	0.346	1
TPSE477*006#0045	E	470	6.3	85	4	125	28	10	45	1.915	1.723	0.766	1 ¹⁾
TPSE477*006#0050	E	470	6.3	85	4	125	28	10	50	1.817	1.635	0.727	1 ¹⁾
TPSE477*006#0060	E	470	6.3	85	4	125	28	10	60	1.658	1.492	0.663	1 ¹⁾
TPSE477*006#0100	E	470	6.3	85	4	125	28	10	100	1.285	1.156	0.514	1 ¹⁾
TPSE477*006#0200	E	470	6.3	85	4	125	28	10	200	0.908	0.817	0.363	1 ¹⁾
TPSV477*006#0040	V	470	6.3	85	4	125	28	10	40	2.500	2.250	1.000	1 ¹⁾
TPSV477*006#0055	V	470	6.3	85	4	125	28	10	55	2.132	1.919	0.853	1 ¹⁾
TPSV477*006#0100	V	470	6.3	85	4	125	28	10	100	1.581	1.423	0.632	1 ¹⁾
TPSY477*006#0150	Y	470	6.3	85	4	125	28.2	20	150	0.913	0.822	0.365	1 ¹⁾
TPSE687*006#0045	E	680	6.3	85	4	125	42.8	10	45	1.915	1.723	0.766	1 ¹⁾
TPSE687*006#0060	E	680	6.3	85	4	125	42.8	10	60	1.658	1.492	0.663	1 ¹⁾
TPSE687*006#0100	E	680	6.3	85	4	125	42.8	10	100	1.285	1.156	0.514	1 ¹⁾
TPSV687*006#0035	V	680	6.3	85	4	125	42.8	10	35	2.673	2.405	1.069	1 ¹⁾
TPSV687*006#0040	V	680	6.3	85	4	125	42.8	10	40	2.500	2.250	1.000	1 ¹⁾
TPSV687*006#0050	V	680	6.3	85	4	125	42.8	10	50	2.236	2.012	0.894	1 ¹⁾
TPSE108M006#0100	E	1000	6.3	85	4	125	60	20	100	1.285	1.156	0.514	1 ¹⁾
TPSV108M006#0040	V	1000	6.3	85	4	125	60	16	40	2.500	2.250	1.000	1 ¹⁾
TPSV108M006#0050	V	1000	6.3	85	4	125	60	16	50	2.236	2.012	0.894	1 ¹⁾
10 Volt @ 85°C													
TPSR105*010#9000	R	1	10	85	7	125	0.5	4	9000	0.078	0.070	0.031	1
TPSA225*010#1800	A	2.2	10	85	7	125	0.5	6	1800	0.204	0.184	0.082	1
TPST335*010#1500	T	3.3	10	85	7	125	0.5	6	1500	0.231	0.208	0.092	1
TPSA475*010#1400	A	4.7	10	85	7	125	0.5	6	1400	0.231	0.208	0.093	1
TPSB475*010#1400	B	4.7	10	85	7	125	0.5	6	1400	0.246	0.222	0.099	1
TPSR475*010#3000	R	4.7	10	85	7	125	0.5	6	3000	0.135	0.122	0.054	1
TPSR475*010#5000	R	4.7	10	85	7	125	0.5	6	5000	0.105	0.094	0.042	1
TPSA685*010#1800	A	6.8	10	85	7	125	0.7	6	1800	0.204	0.184	0.082	1
TPSB685*010#1300	B	6.8	10	85	7	125	0.7	6	1300	0.256	0.230	0.102	1
TPST685*010#1800	T	6.8	10	85	7	125	0.7	6	1800	0.211	0.190	0.084	1
TPSA106*010#0900	A	10	10	85	7	125	1	6	900	0.289	0.260	0.115	1
TPSA106*010#1800	A	10	10	85	7	125	1	6	1800	0.204	0.184	0.082	1
TPSB106*010#1000	B	10	10	85	7	125	1	6	1000	0.292	0.262	0.117	1
TPSP106M010#2000	P	10	10	85	7	125	1	8	2000	0.173	0.156	0.069	1
TPSS106*010#0900	S	10	10	85	7	125	1	8	900	0.269	0.242	0.107	1
TPST106*010#1000	T	10	10	85	7	125	1	6	1000	0.283	0.255	0.113	1
TPST106*010#2000	T	10	10	85	7	125	1	6	2000	0.200	0.180	0.080	1
TPSA156*010#1000	A	15	10	85	7	125	1.5	6	1000	0.274	0.246	0.110	1
TPSB156*010#0450	B	15	10	85	7	125	1.5	6	450	0.435	0.391	0.174	1
TPSB156*010#0600	B	15	10	85	7	125	1.5	6	600	0.376	0.339	0.151	1
TPSC156*010#0700	C	15	10	85	7	125	1.5	6	700	0.396	0.357	0.159	1
TPST156*010#1200	T	15	10	85	7	125	1.5	8	1200	0.258	0.232	0.103	1
TPSA226*010#0900	A	22	10	85	7	125	2.2	8	900	0.289	0.260	0.115	1
TPSB226*010#0400	B	22	10	85	7	125	2.2	6	400	0.461	0.415	0.184	1
TPSB226*010#0500	B	22	10	85	7	125	2.2	6	500	0.412	0.371	0.165	1
TPSB226*010#0700	B	22	10	85	7	125	2.2	6	700	0.348	0.314	0.139	1
TPSC226*010#0300	C	22	10	85	7	125	2.2	6	300	0.606	0.545	0.242	1
TPST226*010#0800	T	22	10	85	7	125	2.2	8	800	0.316	0.285	0.126	1
TPSA336*010#0700	A	33	10	85	7	125	3.3	8	700	0.327	0.295	0.131	1
TPSB336*010#0250	B	33	10	85	7	125	3.3	6	250	0.583	0.525	0.233	1
TPSB336*010#0425	B	33	10	85	7	125	3.3	6	425	0.447	0.402	0.179	1
TPSB336*010#0500	B	33	10	85	7	125	3.3	6	500	0.412	0.371	0.165	1
TPSB336*010#0650	B	33	10	85	7	125	3.3	6	650	0.362	0.325	0.145	1
TPSC336*010#0150	C	33	10	85	7	125	3.3	6	150	0.856	0.771	0.343	1
TPSC336*010#0375	C	33	10	85	7	125	3.3	6	375	0.542	0.487	0.217	1
TPSC336*010#0500	C	33	10	85	7	125	3.3	6	500	0.469	0.422	0.188	1
TPSW336*010#0350	W	33	10	85	7	125	3.3	6	350	0.507	0.456	0.203	1
TPSB476*010#0250	B	47	10	85	7	125	4.7	8	250	0.583	0.525	0.233	1
TPSB476*010#0350	B	47	10	85	7	125	4.7	8	350	0.493	0.444	0.197	1
TPSB476*010#0500	B	47	10	85	7	125	4.7	8	500	0.412	0.371	0.165	1
TPSB476*010#0650	B	47	10	85	7	125	4.7	8	650	0.362	0.325	0.145	1

RATINGS & PART NUMBER REFERENCE

AVX Part No.	Case Size	Capacitance (µF)	Rated Voltage (V)	Rated Temperature (°C)	Category Voltage (V)	Category Temperature (°C)	DCL Max. (µA)	DF Max. (%)	ESR Max. 100kHz (mΩ)	100kHz RMS Current (A)			MSL
										25°C	85°C	125°C	
TPSC476*010#0200	C	47	10	85	7	125	4.7	6	200	0.742	0.667	0.297	1
TPSC476*010#0350	C	47	10	85	7	125	4.7	6	350	0.561	0.505	0.224	1
TPSD476*010#0100	D	47	10	85	7	125	4.7	6	100	1.225	1.102	0.490	1
TPSD476*010#0300	D	47	10	85	7	125	4.7	6	300	0.707	0.636	0.283	1
TPSW476*010#0125	W	47	10	85	7	125	4.7	6	125	0.849	0.764	0.339	1
TPSW476*010#0150	W	47	10	85	7	125	4.7	6	150	0.775	0.697	0.310	1
TPSW476*010#0250	W	47	10	85	7	125	4.7	6	250	0.600	0.540	0.240	1
TPSB686*010#0600	B	68	10	85	7	125	6.8	8	600	0.376	0.339	0.151	1
TPSC686*010#0080	C	68	10	85	7	125	6.8	6	80	1.173	1.055	0.469	1
TPSC686*010#0100	C	68	10	85	7	125	6.8	6	100	1.049	0.944	0.420	1
TPSC686*010#0200	C	68	10	85	7	125	6.8	6	200	0.742	0.667	0.297	1
TPSC686*010#0300	C	68	10	85	7	125	6.8	6	300	0.606	0.545	0.242	1
TPSD686*010#0100	D	68	10	85	7	125	6.8	6	100	1.225	1.102	0.490	1
TPSD686*010#0150	D	68	10	85	7	125	6.8	6	150	1.000	0.900	0.400	1
TPSY686*010#0100	Y	68	10	85	7	125	6.8	6	100	1.118	1.006	0.447	1 ¹⁾
TPSY686*010#0200	Y	68	10	85	7	125	6.8	6	200	0.791	0.712	0.316	1 ¹⁾
TPSW686*010#0100	W	68	10	85	7	125	6.8	6	100	0.949	0.854	0.379	1
TPSW686*010#0150	W	68	10	85	7	125	6.8	6	150	0.775	0.697	0.310	1
TPSB107*010#0400	B	100	10	85	7	125	10	8	400	0.461	0.415	0.184	1
TPSC107*010#0075	C	100	10	85	7	125	10	8	75	1.211	1.090	0.484	1
TPSC107*010#0100	C	100	10	85	7	125	10	8	100	1.049	0.944	0.420	1
TPSC107*010#0150	C	100	10	85	7	125	10	8	150	0.856	0.771	0.343	1
TPSC107*010#0200	C	100	10	85	7	125	10	8	200	0.742	0.667	0.297	1
TPSD107*010#0050	D	100	10	85	7	125	10	6	50	1.732	1.559	0.693	1
TPSD107*010#0065	D	100	10	85	7	125	10	6	65	1.519	1.367	0.608	1
TPSD107*010#0080	D	100	10	85	7	125	10	6	80	1.369	1.232	0.548	1
TPSD107*010#0100	D	100	10	85	7	125	10	6	100	1.225	1.102	0.490	1
TPSD107*010#0125	D	100	10	85	7	125	10	6	125	1.095	0.986	0.438	1
TPSD107*010#0150	D	100	10	85	7	125	10	6	150	1.000	0.900	0.400	1
TPSE107*010#0125	E	100	10	85	7	125	10	6	125	1.149	1.034	0.460	1 ¹⁾
TPSW107*010#0150	W	100	10	85	7	125	10	6	150	0.775	0.697	0.310	1
TPSX107*010#0085	X	100	10	85	7	125	10	8	85	1.085	0.976	0.434	1 ¹⁾
TPSX107*010#0150	X	100	10	85	7	125	10	8	150	0.816	0.735	0.327	1 ¹⁾
TPSX107*010#0200	X	100	10	85	7	125	10	8	200	0.707	0.636	0.283	1 ¹⁾
TPSY107*010#0100	Y	100	10	85	7	125	10	6	100	1.118	1.006	0.447	1 ¹⁾
TPSY107*010#0150	Y	100	10	85	7	125	10	6	150	0.913	0.822	0.365	1 ¹⁾
TPSY107*010#0200	Y	100	10	85	7	125	10	6	200	0.791	0.712	0.316	1 ¹⁾
TPSC157*010#0150	C	150	10	85	7	125	15	8	150	0.856	0.771	0.343	1
TPSD157*010#0050	D	150	10	85	7	125	15	8	50	1.732	1.559	0.693	1
TPSD157*010#0085	D	150	10	85	7	125	15	8	85	1.328	1.196	0.531	1
TPSD157*010#0100	D	150	10	85	7	125	15	8	100	1.225	1.102	0.490	1
TPSE157*010#0100	E	150	10	85	7	125	15	8	100	1.285	1.156	0.514	1 ¹⁾
TPSF157*010#0200	F	150	10	85	7	125	15	10	200	0.707	0.636	0.283	1
TPSX157*010#0100	X	150	10	85	7	125	15	6	100	1.000	0.900	0.400	1 ¹⁾
TPSY157*010#0100	Y	150	10	85	7	125	15	6	100	1.118	1.006	0.447	1 ¹⁾
TPSY157*010#0150	Y	150	10	85	7	125	15	6	150	0.913	0.822	0.365	1 ¹⁾
TPSY157*010#0200	Y	150	10	85	7	125	15	6	200	0.791	0.712	0.316	1 ¹⁾
TPSD227*010#0040	D	220	10	85	7	125	22	8	40	1.936	1.743	0.775	1
TPSD227*010#0050	D	220	10	85	7	125	22	8	50	1.732	1.559	0.693	1
TPSD227*010#0100	D	220	10	85	7	125	22	8	100	1.225	1.102	0.490	1
TPSD227*010#0150	D	220	10	85	7	125	22	8	150	1.000	0.900	0.400	1
TPSE227*010#0050	E	220	10	85	7	125	22	8	50	1.817	1.635	0.727	1 ¹⁾
TPSE227*010#0060	E	220	10	85	7	125	22	8	60	1.658	1.492	0.663	1 ¹⁾
TPSE227*010#0070	E	220	10	85	7	125	22	8	70	1.535	1.382	0.614	1 ¹⁾
TPSE227*010#0100	E	220	10	85	7	125	22	8	100	1.285	1.156	0.514	1 ¹⁾
TPSE227*010#0125	E	220	10	85	7	125	22	8	125	1.149	1.034	0.460	1 ¹⁾
TPSE227*010#0150	E	220	10	85	7	125	22	8	150	1.049	0.944	0.420	1 ¹⁾
TPSY227*010#0100	Y	220	10	85	7	125	22	10	100	1.118	1.006	0.447	1 ¹⁾
TPSY227*010#0150	Y	220	10	85	7	125	22	10	150	0.913	0.822	0.365	1 ¹⁾
TPSY227*010#0200	Y	220	10	85	7	125	22	10	200	0.791	0.712	0.316	1 ¹⁾
TPSD337*010#0050	D	330	10	85	7	125	33	8	50	1.732	1.559	0.693	1
TPSD337*010#0065	D	330	10	85	7	125	33	8	65	1.519	1.367	0.608	1
TPSD337*010#0100	D	330	10	85	7	125	33	8	100	1.225	1.102	0.490	1
TPSD337*010#0150	D	330	10	85	7	125	33	8	150	1.000	0.900	0.400	1
TPSE337*010#0040	E	330	10	85	7	125	33	8	40	2.031	1.828	0.812	1 ¹⁾
TPSE337*010#0050	E	330	10	85	7	125	33	8	50	1.817	1.635	0.727	1 ¹⁾
TPSE337*010#0060	E	330	10	85	7	125	33	8	60	1.658	1.492	0.663	1 ¹⁾
TPSE337*010#0100	E	330	10	85	7	125	33	8	100	1.285	1.156	0.514	1 ¹⁾
TPSV337*010#0040	V	330	10	85	7	125	33	10	40	2.500	2.250	1.000	1 ¹⁾
TPSV337*010#0060	V	330	10	85	7	125	33	10	60	2.041	1.837	0.816	1 ¹⁾
TPSV337*010#0100	V	330	10	85	7	125	33	10	100	1.581	1.423	0.632	1 ¹⁾
TPSE477*010#0045	E	470	10	85	7	125	47	10	45	1.915	1.723	0.766	1 ¹⁾

RATINGS & PART NUMBER REFERENCE

AVX Part No.	Case Size	Capacitance (µF)	Rated Voltage (V)	Rated Temperature (°C)	Category Voltage (V)	Category Temperature (°C)	DCL Max. (µA)	DF Max. (%)	ESR Max. @ 100kHz (mΩ)	100kHz RMS Current (A)			MSL
										25°C	85°C	125°C	
TPSE477*010#0050	E	470	10	85	7	125	47	10	50	1.817	1.635	0.727	1 ¹⁾
TPSE477*010#0060	E	470	10	85	7	125	47	10	60	1.658	1.492	0.663	1 ¹⁾
TPSE477*010#0100	E	470	10	85	7	125	47	10	100	1.285	1.156	0.514	1 ¹⁾
TPSE477*010#0200	E	470	10	85	7	125	47	10	200	0.908	0.817	0.363	1 ¹⁾
TPSV477*010#0040	V	470	10	85	7	125	47	10	40	2.500	2.250	1.000	1 ¹⁾
TPSV477*010#0060	V	470	10	85	7	125	47	10	60	2.041	1.837	0.816	1 ¹⁾
TPSV477*010#0100	V	470	10	85	7	125	47	10	100	1.581	1.423	0.632	1 ¹⁾
TPSE687M010#0150V	E	680	10	85	7	125	68	18	150	1.049	0.944	0.420	3
TPSV687M010#0100V	V	680	10	85	7	125	68	18	100	1.581	1.423	0.632	3
16 Volt @ 85°C													
TPSA105*016#6200	A	1	16	85	10	125	0.5	4	6200	0.110	0.099	0.044	1
TPSA225*016#1800	A	2.2	16	85	10	125	0.5	6	1800	0.204	0.184	0.082	1
TPSA225*016#3500	A	2.2	16	85	10	125	0.5	6	3500	0.146	0.132	0.059	1
TPST225*016#2000	T	2.2	16	85	10	125	0.5	6	2000	0.200	0.180	0.080	1
TPSA335*016#3500	A	3.3	16	85	10	125	0.5	6	3500	0.146	0.132	0.059	1
TPSB335*016#2500	B	3.3	16	85	10	125	0.5	6	2500	0.184	0.166	0.074	1
TPSA475*016#2000	A	4.7	16	85	10	125	0.8	6	2000	0.194	0.174	0.077	1
TPSB475*016#0800	B	4.7	16	85	10	125	0.8	6	800	0.326	0.293	0.130	1
TPSB475*016#1500	B	4.7	16	85	10	125	0.8	6	1500	0.238	0.214	0.095	1
TPSA685*016#1500	A	6.8	16	85	10	125	1.1	6	1500	0.224	0.201	0.089	1
TPSB685*016#0600	B	6.8	16	85	10	125	1.1	6	600	0.376	0.339	0.151	1
TPSB685*016#1200	B	6.8	16	85	10	125	1.1	6	1200	0.266	0.240	0.106	1
TPSA106*016#1000	A	10	16	85	10	125	1.6	6	1000	0.274	0.246	0.110	1
TPSB106*016#0500	B	10	16	85	10	125	1.6	6	500	0.412	0.371	0.165	1
TPSB106*016#0800	B	10	16	85	10	125	1.6	6	800	0.326	0.293	0.130	1
TPSC106*016#0500	C	10	16	85	10	125	1.6	6	500	0.469	0.422	0.188	1
TPST106*016#0800	T	10	16	85	10	125	1.6	8	800	0.316	0.285	0.126	1
TPST106*016#1000	T	10	16	85	10	125	1.6	8	1000	0.283	0.255	0.113	1
TPSW106*016#0500	W	10	16	85	10	125	1.6	6	500	0.424	0.382	0.170	1
TPSW106*016#0600	W	10	16	85	10	125	1.6	6	600	0.387	0.349	0.155	1
TPSB156*016#0500	B	15	16	85	10	125	2.4	6	500	0.412	0.371	0.165	1
TPSB156*016#0800	B	15	16	85	10	125	2.4	6	800	0.326	0.293	0.130	1
TPSC156*016#0300	C	15	16	85	10	125	2.4	6	300	0.606	0.545	0.242	1
TPSC156*016#0700	C	15	16	85	10	125	2.4	6	700	0.396	0.357	0.159	1
TPSB226*016#0400	B	22	16	85	10	125	3.5	6	400	0.461	0.415	0.184	1
TPSB226*016#0600	B	22	16	85	10	125	3.5	6	600	0.376	0.339	0.151	1
TPSC226*016#0150	C	22	16	85	10	125	3.5	6	150	0.856	0.771	0.343	1
TPSC226*016#0250	C	22	16	85	10	125	3.5	6	250	0.663	0.597	0.265	1
TPSC226*016#0300	C	22	16	85	10	125	3.5	6	300	0.606	0.545	0.242	1
TPSC226*016#0375	C	22	16	85	10	125	3.5	6	375	0.542	0.487	0.217	1
TPSD226*016#0700	D	22	16	85	10	125	3.5	6	700	0.463	0.417	0.185	1
TPSW226*016#0500	W	22	16	85	10	125	3.5	6	500	0.424	0.382	0.170	1
TPSB336*016#0350	B	33	16	85	10	125	5.3	8	350	0.493	0.444	0.197	1
TPSB336*016#0500	B	33	16	85	10	125	5.3	8	500	0.412	0.371	0.165	1
TPSC336*016#0100	C	33	16	85	10	125	5.3	6	100	1.049	0.944	0.420	1
TPSC336*016#0150	C	33	16	85	10	125	5.3	6	150	0.856	0.771	0.343	1
TPSC336*016#0225	C	33	16	85	10	125	5.3	6	225	0.699	0.629	0.280	1
TPSC336*016#0300	C	33	16	85	10	125	5.3	6	300	0.606	0.545	0.242	1
TPSD336*016#0200	D	33	16	85	10	125	5.3	6	200	0.866	0.779	0.346	1
TPSW336*016#0140	W	33	16	85	10	125	5.3	6	140	0.802	0.722	0.321	1
TPSW336*016#0175	W	33	16	85	10	125	5.3	6	175	0.717	0.645	0.287	1
TPSW336*016#0250	W	33	16	85	10	125	5.3	6	250	0.600	0.540	0.240	1
TPSW336*016#0400	W	33	16	85	10	125	5.3	6	400	0.474	0.427	0.190	1
TPSW336*016#0500	W	33	16	85	10	125	5.3	6	500	0.424	0.382	0.170	1
TPSY336*016#0300	Y	33	16	85	10	125	5.3	6	300	0.645	0.581	0.258	1 ¹⁾
TPSY336*016#0400	Y	33	16	85	10	125	5.3	6	400	0.559	0.503	0.224	1 ¹⁾
TPSC476*016#0110	C	47	16	85	10	125	7.5	6	110	1.000	0.900	0.400	1
TPSC476*016#0350	C	47	16	85	10	125	7.5	6	350	0.561	0.505	0.224	1
TPSD476*016#0080	D	47	16	85	10	125	7.5	6	80	1.369	1.232	0.548	1
TPSD476*016#0100	D	47	16	85	10	125	7.5	6	100	1.225	1.102	0.490	1
TPSD476*016#0150	D	47	16	85	10	125	7.5	6	150	1.000	0.900	0.400	1
TPSD476*016#0200	D	47	16	85	10	125	7.5	6	200	0.866	0.779	0.346	1
TPSW476*016#0200	W	47	16	85	10	125	7.5	6	200	0.671	0.604	0.268	1
TPSX476*016#0180	X	47	16	85	10	125	7.5	6	180	0.745	0.671	0.298	1 ¹⁾
TPSY476*016#0250	Y	47	16	85	10	125	7.5	6	250	0.707	0.636	0.283	1 ¹⁾
TPSC686*016#0125	C	68	16	85	10	125	10.9	6	125	0.938	0.844	0.375	1
TPSC686*016#0200	C	68	16	85	10	125	10.9	6	200	0.742	0.667	0.297	1
TPSD686*016#0070	D	68	16	85	10	125	10.9	6	70	1.464	1.317	0.586	1
TPSD686*016#0100	D	68	16	85	10	125	10.9	6	100	1.225	1.102	0.490	1
TPSD686*016#0150	D	68	16	85	10	125	10.9	6	150	1.000	0.900	0.400	1
TPSF686*016#0200	F	68	16	85	10	125	10.9	10	200	0.707	0.636	0.283	1
TPSX686*016#0150	X	68	16	85	10	125	10.9	8	150	0.816	0.735	0.327	1 ¹⁾

RATINGS & PART NUMBER REFERENCE

AVX Part No.	Case Size	Capacitance (µF)	Rated Voltage (V)	Rated Temperature (°C)	Category Voltage (V)	Category Temperature (°C)	DCL Max. (µA)	DF Max. (%)	ESR Max. @ 100kHz (mΩ)	100kHz RMS Current (A)			MSL
										25°C	85°C	125°C	
TPSY686*016#0150	Y	68	16	85	10	125	10.9	6	150	0.913	0.822	0.365	1 ¹⁾
TPSY686*016#0200	Y	68	16	85	10	125	10.9	6	200	0.791	0.712	0.316	1 ¹⁾
TPSY686*016#0250	Y	68	16	85	10	125	10.9	6	250	0.707	0.636	0.283	1 ¹⁾
TPSC107*016#0200	C	100	16	85	10	125	16	8	200	0.742	0.667	0.297	1
TPSD107*016#0060	D	100	16	85	10	125	16	6	60	1.581	1.423	0.632	1
TPSD107*016#0100	D	100	16	85	10	125	16	6	100	1.225	1.102	0.490	1
TPSD107*016#0125	D	100	16	85	10	125	16	6	125	1.095	0.986	0.438	1
TPSD107*016#0150	D	100	16	85	10	125	16	6	150	1.000	0.900	0.400	1
TPSE107*016#0055	E	100	16	85	10	125	16	6	55	1.732	1.559	0.693	1 ¹⁾
TPSE107*016#0100	E	100	16	85	10	125	16	6	100	1.285	1.156	0.514	1 ¹⁾
TPSE107*016#0125	E	100	16	85	10	125	16	6	125	1.149	1.034	0.460	1 ¹⁾
TPSE107*016#0150	E	100	16	85	10	125	16	6	150	1.049	0.944	0.420	1 ¹⁾
TPSF107M016#0150	F	100	16	85	10	125	16	10	150	0.816	0.735	0.327	1
TPSF107M016#0200	F	100	16	85	10	125	16	10	200	0.707	0.636	0.283	1
TPSY107*016#0100	Y	100	16	85	10	125	16	8	100	1.118	1.006	0.447	1 ¹⁾
TPSY107*016#0150	Y	100	16	85	10	125	16	8	150	0.913	0.822	0.365	1 ¹⁾
TPSY107*016#0200	Y	100	16	85	10	125	16	8	200	0.791	0.712	0.316	1 ¹⁾
TPSD157*016#0060	D	150	16	85	10	125	24	6	60	1.581	1.423	0.632	1
TPSD157*016#0085	D	150	16	85	10	125	24	6	85	1.328	1.196	0.531	1
TPSD157*016#0100	D	150	16	85	10	125	24	6	100	1.225	1.102	0.490	1
TPSD157*016#0125	D	150	16	85	10	125	24	6	125	1.095	0.986	0.438	1
TPSD157*016#0150	D	150	16	85	10	125	24	6	150	1.000	0.900	0.400	1
TPSE157*016#0050V	E	150	16	85	10	125	24	8	50	1.817	1.635	0.727	3
TPSE157*016#0100	E	150	16	85	10	125	24	8	100	1.285	1.156	0.514	1 ¹⁾
TPSV157*016#0045	V	150	16	85	10	125	24	8	45	2.357	2.121	0.943	1 ¹⁾
TPSV157*016#0075	V	150	16	85	10	125	24	8	75	1.826	1.643	0.730	1 ¹⁾
TPSY157M016#0200	Y	150	16	85	10	125	24	15	200	0.791	0.712	0.316	1 ¹⁾
TPSD227M016#0200V	D	220	16	85	10	125	35.2	10	200	0.866	0.779	0.346	3
TPSE227*016#0050V	E	220	16	85	10	125	35.2	10	50	1.817	1.635	0.727	3
TPSE227*016#0100	E	220	16	85	10	125	35.2	10	100	1.285	1.156	0.514	1 ¹⁾
TPSE227*016#0150	E	220	16	85	10	125	35.2	10	150	1.049	0.944	0.420	1 ¹⁾
TPSV227*016#0050	V	220	16	85	10	125	35.2	8	50	2.236	2.012	0.894	1 ¹⁾
TPSV227*016#0075	V	220	16	85	10	125	35.2	8	75	1.826	1.643	0.730	1 ¹⁾
TPSV227*016#0100	V	220	16	85	10	125	35.2	8	100	1.581	1.423	0.632	1 ¹⁾
TPSV227*016#0150	V	220	16	85	10	125	35.2	8	150	1.291	1.162	0.516	1 ¹⁾
TPSE337M016#0200	E	330	16	85	10	125	52.8	30	200	0.908	0.817	0.363	1 ¹⁾
20 Volt @ 85°C													
TPSA105*020#3000	A	1	20	85	13	125	0.5	4	3000	0.158	0.142	0.063	1
TPSR105*020#6000	R	1	20	85	13	125	0.5	4	6000	0.096	0.086	0.038	1
TPSS105*020#6000	S	1	20	85	13	125	0.5	4	6000	0.104	0.094	0.042	1
TPST105*020#2000	T	1	20	85	13	125	0.5	4	2000	0.200	0.180	0.080	1
TPSA155*020#3000	A	1.5	20	85	13	125	0.5	6	3000	0.158	0.142	0.063	1
TPSA225*020#3000	A	2.2	20	85	13	125	0.5	6	3000	0.158	0.142	0.063	1
TPSB225*020#1700	B	2.2	20	85	13	125	0.5	6	1700	0.224	0.201	0.089	1
TPSA335*020#2500	A	3.3	20	85	13	125	0.7	6	2500	0.173	0.156	0.069	1
TPSB335*020#1300	B	3.3	20	85	13	125	0.7	6	1300	0.256	0.230	0.102	1
TPSA475*020#1800	A	4.7	20	85	13	125	0.9	6	1800	0.204	0.184	0.082	1
TPSB475*020#0750	B	4.7	20	85	13	125	0.9	6	750	0.337	0.303	0.135	1
TPSB475*020#1000	B	4.7	20	85	13	125	0.9	6	1000	0.292	0.262	0.117	1
TPSA685*020#1000	A	6.8	20	85	13	125	1.4	6	1000	0.274	0.246	0.110	1
TPSB685*020#0600	B	6.8	20	85	13	125	1.4	6	600	0.376	0.339	0.151	1
TPSB685*020#1000	B	6.8	20	85	13	125	1.4	6	1000	0.292	0.262	0.117	1
TPSC685*020#0700	C	6.8	20	85	13	125	1.4	6	700	0.396	0.357	0.159	1
TPSB106*020#0500	B	10	20	85	13	125	2	6	500	0.412	0.371	0.165	1
TPSB106*020#1000	B	10	20	85	13	125	2	6	1000	0.292	0.262	0.117	1
TPSC106*020#0500	C	10	20	85	13	125	2	6	500	0.469	0.422	0.188	1
TPSC106*020#0700	C	10	20	85	13	125	2	6	700	0.396	0.357	0.159	1
TPSW106*020#0250	W	10	20	85	13	125	2	6	250	0.600	0.540	0.240	1
TPSW106*020#0500	W	10	20	85	13	125	2	6	500	0.424	0.382	0.170	1
TPSB156*020#0500	B	15	20	85	13	125	3	6	500	0.412	0.371	0.165	1
TPSC156*020#0400	C	15	20	85	13	125	3	6	400	0.524	0.472	0.210	1
TPSC156*020#0450	C	15	20	85	13	125	3	6	450	0.494	0.445	0.198	1
TPSB226*020#0400	B	22	20	85	13	125	4.4	6	400	0.461	0.415	0.184	1
TPSB226*020#0600	B	22	20	85	13	125	4.4	6	600	0.376	0.339	0.151	1
TPSC226*020#0100	C	22	20	85	13	125	4.4	6	100	1.049	0.944	0.420	1
TPSC226*020#0150	C	22	20	85	13	125	4.4	6	150	0.856	0.771	0.343	1
TPSC226*020#0400	C	22	20	85	13	125	4.4	6	400	0.524	0.472	0.210	1
TPSD226*020#0200	D	22	20	85	13	125	4.4	6	200	0.866	0.779	0.346	1
TPSD226*020#0300	D	22	20	85	13	125	4.4	6	300	0.707	0.636	0.283	1
TPSC336*020#0300	C	33	20	85	13	125	6.6	6	300	0.606	0.545	0.242	1
TPSD336*020#0100	D	33	20	85	13	125	6.6	6	100	1.225	1.102	0.490	1
TPSD336*020#0200	D	33	20	85	13	125	6.6	6	200	0.866	0.779	0.346	1

RATINGS & PART NUMBER REFERENCE

AVX Part No.	Case Size	Capacitance (µF)	Rated Voltage (V)	Rated Temperature (°C)	Category Voltage (V)	Category Temperature (°C)	DCL Max. (µA)	DF Max. (%)	ESR Max. @ 100kHz (mΩ)	100kHz RMS Current (A)			MSL
										25°C	85°C	125°C	
TPSD476*020#0075	D	47	20	85	13	125	9.4	6	75	1.414	1.273	0.566	1
TPSD476*020#0100	D	47	20	85	13	125	9.4	6	100	1.225	1.102	0.490	1
TPSD476*020#0200	D	47	20	85	13	125	9.4	6	200	0.866	0.779	0.346	1
TPSE476*020#0070	E	47	20	85	13	125	9.4	6	70	1.535	1.382	0.614	1 ¹⁾
TPSE476*020#0125	E	47	20	85	13	125	9.4	6	125	1.149	1.034	0.460	1 ¹⁾
TPSE476*020#0150	E	47	20	85	13	125	9.4	6	150	1.049	0.944	0.420	1 ¹⁾
TPSE476*020#0200	E	47	20	85	13	125	9.4	6	200	0.908	0.817	0.363	1 ¹⁾
TPSE476*020#0250	E	47	20	85	13	125	9.4	6	250	0.812	0.731	0.325	1 ¹⁾
TPSX476*020#0200	X	47	20	85	13	125	9.4	6	200	0.707	0.636	0.283	1 ¹⁾
TPSD686*020#0070	D	68	20	85	13	125	13.6	6	70	1.464	1.317	0.586	1
TPSD686*020#0150	D	68	20	85	13	125	13.6	6	150	1.000	0.900	0.400	1
TPSD686*020#0200	D	68	20	85	13	125	13.6	6	200	0.866	0.779	0.346	1
TPSD686*020#0300	D	68	20	85	13	125	13.6	6	300	0.707	0.636	0.283	1
TPSE686*020#0125	E	68	20	85	13	125	13.6	6	125	1.149	1.034	0.460	1 ¹⁾
TPSE686*020#0150	E	68	20	85	13	125	13.6	6	150	1.049	0.944	0.420	1 ¹⁾
TPSE686*020#0200	E	68	20	85	13	125	13.6	6	200	0.908	0.817	0.363	1 ¹⁾
TPSY686*020#0200	Y	68	20	85	13	125	13.6	6	200	0.791	0.712	0.316	1 ¹⁾
TPSD107*020#0085	D	100	20	85	13	125	20	6	85	1.328	1.196	0.531	1
TPSD107*020#0100	D	100	20	85	13	125	20	6	100	1.225	1.102	0.490	1
TPSD107*020#0150	D	100	20	85	13	125	20	6	150	1.000	0.900	0.400	1
TPSE107*020#0100	E	100	20	85	13	125	20	6	100	1.285	1.156	0.514	1 ¹⁾
TPSE107*020#0150	E	100	20	85	13	125	20	6	150	1.049	0.944	0.420	1 ¹⁾
TPSE107*020#0200	E	100	20	85	13	125	20	6	200	0.908	0.817	0.363	1 ¹⁾
TPSV107*020#0060	V	100	20	85	13	125	20	8	60	2.041	1.837	0.816	1 ¹⁾
TPSV107*020#0085	V	100	20	85	13	125	20	8	85	1.715	1.543	0.686	1 ¹⁾
TPSV107*020#0100	V	100	20	85	13	125	20	8	100	1.581	1.423	0.632	1 ¹⁾
TPSV107*020#0200	V	100	20	85	13	125	20	8	200	1.118	1.006	0.447	1 ¹⁾
TPSV157*020#0080	V	150	20	85	13	125	30	8	80	1.768	1.591	0.707	1 ¹⁾
25 Volt @ 85°C													
TPSA474*025#7000	A	0.47	25	85	17	125	0.5	4	7000	0.104	0.093	0.041	1
TPSA684*025#6000	A	0.68	25	85	17	125	0.5	4	6000	0.112	0.101	0.045	1
TPSA105*025#4000	A	1	25	85	17	125	0.5	4	4000	0.137	0.123	0.055	1
TPSR105*025#2500	R	1	25	85	17	125	0.5	4	2500	0.148	0.133	0.059	1
TPSR105*025#4000	R	1	25	85	17	125	0.5	4	4000	0.117	0.106	0.047	1
TPSA155*025#3000	A	1.5	25	85	17	125	0.5	6	3000	0.158	0.142	0.063	1
TPSB155*025#1800	B	1.5	25	85	17	125	0.5	6	1800	0.217	0.196	0.087	1
TPSA225*025#2500	A	2.2	25	85	17	125	0.6	6	2500	0.173	0.156	0.069	1
TPSB225*025#0900	B	2.2	25	85	17	125	0.6	6	900	0.307	0.277	0.123	1
TPSB225*025#1200	B	2.2	25	85	17	125	0.6	6	1200	0.266	0.240	0.106	1
TPSB225*025#2500	B	2.2	25	85	17	125	0.6	6	2500	0.184	0.166	0.074	1
TPSA335*025#1000	A	3.3	25	85	17	125	0.8	6	1000	0.274	0.246	0.110	1
TPSA335*025#1500	A	3.3	25	85	17	125	0.8	6	1500	0.224	0.201	0.089	1
TPSB335*025#0750	B	3.3	25	85	17	125	0.8	6	750	0.337	0.303	0.135	1
TPSB335*025#1500	B	3.3	25	85	17	125	0.8	6	1500	0.238	0.214	0.095	1
TPSB335*025#2000	B	3.3	25	85	17	125	0.8	6	2000	0.206	0.186	0.082	1
TPSB475*025#0700	B	4.7	25	85	17	125	1.2	6	700	0.348	0.314	0.139	1
TPSB475*025#0900	B	4.7	25	85	17	125	1.2	6	900	0.307	0.277	0.123	1
TPSB475*025#1500	B	4.7	25	85	17	125	1.2	6	1500	0.238	0.214	0.095	1
TPSC475*025#0700	C	4.7	25	85	17	125	1.2	6	700	0.396	0.357	0.159	1
TPSB685*025#0700	B	6.8	25	85	17	125	1.7	6	700	0.348	0.314	0.139	1
TPSC685*025#0500	C	6.8	25	85	17	125	1.7	6	500	0.469	0.422	0.188	1
TPSC685*025#0600	C	6.8	25	85	17	125	1.7	6	600	0.428	0.385	0.171	1
TPSC685*025#0700	C	6.8	25	85	17	125	1.7	6	700	0.396	0.357	0.159	1
TPSB106*025#1800	B	10	25	85	17	125	2.5	6	1800	0.217	0.196	0.087	1
TPSC106*025#0300	C	10	25	85	17	125	2.5	6	300	0.606	0.545	0.242	1
TPSC106*025#0500	C	10	25	85	17	125	2.5	6	500	0.469	0.422	0.188	1
TPSD106*025#0500	D	10	25	85	17	125	2.5	6	500	0.548	0.493	0.219	1
TPSC156*025#0220	C	15	25	85	17	125	3.8	6	220	0.707	0.636	0.283	1
TPSC156*025#0300	C	15	25	85	17	125	3.8	6	300	0.606	0.545	0.242	1
TPSD156*025#0100	D	15	25	85	17	125	3.8	6	100	1.225	1.102	0.490	1
TPSD156*025#0300	D	15	25	85	17	125	3.8	6	300	0.707	0.636	0.283	1
TPSC226*025#0275	C	22	25	85	17	125	5.5	6	275	0.632	0.569	0.253	1
TPSC226*025#0400	C	22	25	85	17	125	5.5	6	400	0.524	0.472	0.210	1
TPSD226*025#0100	D	22	25	85	17	125	5.5	6	100	1.225	1.102	0.490	1
TPSD226*025#0200	D	22	25	85	17	125	5.5	6	200	0.866	0.779	0.346	1
TPSD226*025#0300	D	22	25	85	17	125	5.5	6	300	0.707	0.636	0.283	1
TPSF226*025#0300	F	22	25	85	17	125	5.5	6	300	0.577	0.520	0.231	1
TPSC336*025#0400	C	33	25	85	17	125	8.3	6	400	0.524	0.472	0.210	1
TPSD336*025#0100	D	33	25	85	17	125	8.3	6	100	1.225	1.102	0.490	1
TPSD336*025#0200	D	33	25	85	17	125	8.3	6	200	0.866	0.779	0.346	1
TPSD336*025#0300	D	33	25	85	17	125	8.3	6	300	0.707	0.636	0.283	1
TPSE336*025#0100	E	33	25	85	17	125	8.3	6	100	1.285	1.156	0.514	1 ¹⁾

RATINGS & PART NUMBER REFERENCE

AVX Part No.	Case Size	Capacitance (µF)	Rated Voltage (V)	Rated Temperature (°C)	Category Voltage (V)	Category Temperature (°C)	DCL Max. (µA)	DF Max. (%)	ESR Max. @ 100kHz (mΩ)	100kHz RMS Current (A)			MSL
										25°C	85°C	125°C	
TPSE336*025#0175	E	33	25	85	17	125	8.3	6	175	0.971	0.874	0.388	1 ¹⁾
TPSE336*025#0200	E	33	25	85	17	125	8.3	6	200	0.908	0.817	0.363	1 ¹⁾
TPSE336*025#0300	E	33	25	85	17	125	8.3	6	300	0.742	0.667	0.297	1 ¹⁾
TPSF336*025#0150	F	33	25	85	17	125	8.3	6	150	0.816	0.735	0.327	1 ¹⁾
TPSF336*025#0200	F	33	25	85	17	125	8.3	6	200	0.707	0.636	0.283	1
TPSF336*025#0400	F	33	25	85	17	125	8.3	6	400	0.500	0.450	0.200	1
TPSY336*025#0200	Y	33	25	85	17	125	8.3	6	200	0.791	0.712	0.316	1 ¹⁾
TPSD476*025#0125	D	47	25	85	17	125	11.8	6	125	1.095	0.986	0.438	1
TPSD476*025#0150	D	47	25	85	17	125	11.8	6	150	1.000	0.900	0.400	1
TPSD476*025#0250	D	47	25	85	17	125	11.8	6	250	0.775	0.697	0.310	1
TPSE476*025#0080	E	47	25	85	17	125	11.8	6	80	1.436	1.293	0.574	1 ¹⁾
TPSE476*025#0100	E	47	25	85	17	125	11.8	6	100	1.285	1.156	0.514	1 ¹⁾
TPSE476*025#0125	E	47	25	85	17	125	11.8	6	125	1.149	1.034	0.460	1 ¹⁾
TPSY476*025#0250	Y	47	25	85	17	125	11.8	6	250	0.707	0.636	0.283	1 ¹⁾
TPSD686*025#0150	D	68	25	85	17	125	17	6	150	1.000	0.900	0.400	1
TPSD686*025#0200	D	68	25	85	17	125	17	6	200	0.866	0.779	0.346	1
TPSD686*025#0300	D	68	25	85	17	125	17	6	300	0.707	0.636	0.283	1
TPSE686*025#0125	E	68	25	85	17	125	17	6	125	1.149	1.034	0.460	1 ¹⁾
TPSE686*025#0200	E	68	25	85	17	125	17	6	200	0.908	0.817	0.363	1 ¹⁾
TPSV686*025#0080	V	68	25	85	17	125	17	6	80	1.768	1.591	0.707	1 ¹⁾
TPSV686*025#0095	V	68	25	85	17	125	17	6	95	1.622	1.460	0.649	1 ¹⁾
TPSV686*025#0150	V	68	25	85	17	125	17	6	150	1.291	1.162	0.516	1 ¹⁾
TPSV686*025#0200	V	68	25	85	17	125	17	6	200	1.118	1.006	0.447	1 ¹⁾
TPSE107*025#0150	E	100	25	85	17	125	25	10	150	1.049	0.944	0.420	1 ¹⁾
TPSV107*025#0100	V	100	25	85	17	125	25	8	100	1.581	1.423	0.632	1 ¹⁾
TPSV157M025#0150	V	150	25	85	17	125	37.5	10	150	1.291	1.162	0.516	1 ¹⁾
35 Volt @ 85°C													
TPSA224*035#6000	A	0.22	35	85	23	125	0.5	4	6000	0.112	0.101	0.045	1
TPSA334*035#6000	A	0.33	35	85	23	125	0.5	4	6000	0.112	0.101	0.045	1
TPSA474*035#6000	A	0.47	35	85	23	125	0.5	4	6000	0.112	0.101	0.045	1
TPSB474*035#4000	B	0.47	35	85	23	125	0.5	4	4000	0.146	0.131	0.058	1
TPSA684*035#6000	A	0.68	35	85	23	125	0.5	4	6000	0.112	0.101	0.045	1
TPSA105*035#3000	A	1	35	85	23	125	0.5	4	3000	0.158	0.142	0.063	1
TPSB105*035#2000	B	1	35	85	23	125	0.5	4	2000	0.206	0.186	0.082	1
TPSA155*035#3000	A	1.5	35	85	23	125	0.5	6	3000	0.158	0.142	0.063	1
TPSB155*035#2500	B	1.5	35	85	23	125	0.5	6	2500	0.184	0.166	0.074	1
TPSA225*035#1500	A	2.2	35	85	23	125	0.8	6	1500	0.224	0.201	0.089	1
TPSB225*035#0750	B	2.2	35	85	23	125	0.8	6	750	0.337	0.303	0.135	1
TPSB225*035#1500	B	2.2	35	85	23	125	0.8	6	1500	0.238	0.214	0.095	1
TPSB225*035#2000	B	2.2	35	85	23	125	0.8	6	2000	0.206	0.186	0.082	1
TPSC225*035#1000	C	2.2	35	85	23	125	0.8	6	1000	0.332	0.298	0.133	1
TPSB335*035#1000	B	3.3	35	85	23	125	1.2	6	1000	0.292	0.262	0.117	1
TPSC335*035#0700	C	3.3	35	85	23	125	1.2	6	700	0.396	0.357	0.159	1
TPSB475*035#0700	B	4.7	35	85	23	125	1.6	6	700	0.348	0.314	0.139	1
TPSB475*035#1500	B	4.7	35	85	23	125	1.6	6	1500	0.238	0.214	0.095	1
TPSC475*035#0600	C	4.7	35	85	23	125	1.6	6	600	0.428	0.385	0.171	1
TPSD475*035#0700	D	4.7	35	85	23	125	1.6	6	700	0.463	0.417	0.185	1
TPSC685*035#0350	C	6.8	35	85	23	125	2.4	6	350	0.561	0.505	0.224	1
TPSD685*035#0150	D	6.8	35	85	23	125	2.4	6	150	1.000	0.900	0.400	1
TPSD685*035#0400	D	6.8	35	85	23	125	2.4	6	400	0.612	0.551	0.245	1
TPSD685*035#0500	D	6.8	35	85	23	125	2.4	6	500	0.548	0.493	0.219	1
TPSC106*035#0600	C	10	35	85	23	125	3.5	6	600	0.428	0.385	0.171	1
TPSD106*035#0125	D	10	35	85	23	125	3.5	6	125	1.095	0.986	0.438	1
TPSD106*035#0300	D	10	35	85	23	125	3.5	6	300	0.707	0.636	0.283	1
TPSE106*035#0100V	E	10	35	85	23	125	3.5	6	100	1.285	1.156	0.514	3
TPSE106*035#0150V	E	10	35	85	23	125	3.5	6	150	1.049	0.944	0.420	3
TPSE106*035#0200	E	10	35	85	23	125	3.5	6	200	0.908	0.817	0.363	1 ¹⁾
TPSY106*035#0250	Y	10	35	85	23	125	3.5	6	250	0.707	0.636	0.283	1 ¹⁾
TPSC156*035#0350	C	15	35	85	23	125	5.3	6	350	0.561	0.505	0.224	1
TPSC156*035#0450	C	15	35	85	23	125	5.3	6	450	0.494	0.445	0.198	1
TPSD156*035#0100	D	15	35	85	23	125	5.3	6	100	1.225	1.102	0.490	1
TPSD156*035#0300	D	15	35	85	23	125	5.3	6	300	0.707	0.636	0.283	1
TPSY156*035#0250	Y	15	35	85	23	125	5.3	6	250	0.707	0.636	0.283	1 ¹⁾
TPSD226*035#0125	D	22	35	85	23	125	7.7	6	125	1.095	0.986	0.438	1
TPSD226*035#0200	D	22	35	85	23	125	7.7	6	200	0.866	0.779	0.346	1
TPSD226*035#0300	D	22	35	85	23	125	7.7	6	300	0.707	0.636	0.283	1
TPSD226*035#0400	D	22	35	85	23	125	7.7	6	400	0.612	0.551	0.245	1
TPSE226*035#0125	E	22	35	85	23	125	7.7	6	125	1.149	1.034	0.460	1 ¹⁾
TPSE226*035#0200	E	22	35	85	23	125	7.7	6	200	0.908	0.817	0.363	1 ¹⁾
TPSE226*035#0300	E	22	35	85	23	125	7.7	6	300	0.742	0.667	0.297	1 ¹⁾
TPSY226*035#0200	Y	22	35	85	23	125	7.7	6	200	0.791	0.712	0.316	1 ¹⁾
TPSD336*035#0200	D	33	35	85	23	125	11.6	6	200	0.866	0.779	0.346	1
TPSD336*035#0300	D	33	35	85	23	125	11.6	6	300	0.707	0.636	0.283	1

RATINGS & PART NUMBER REFERENCE

AVX Part No.	Case Size	Capacitance (µF)	Rated Voltage (V)	Rated Temperature (°C)	Category Voltage (V)	Category Temperature (°C)	DCL Max. (µA)	DF Max. (%)	ESR Max. 100kHz (mΩ)	100kHz RMS Current (A)			MSL
										25°C	85°C	125°C	
TPSE336*035#0100	E	33	35	85	23	125	11.6	6	100	1.285	1.156	0.514	1 ¹⁾
TPSE336*035#0250	E	33	35	85	23	125	11.6	6	250	0.812	0.731	0.325	1 ¹⁾
TPSE336*035#0300	E	33	35	85	23	125	11.6	6	300	0.742	0.667	0.297	1 ¹⁾
TPSV336*035#0200	V	33	35	85	23	125	11.6	6	200	1.118	1.006	0.447	1 ¹⁾
TPSD476*035#0300V	D	47	35	85	23	125	16.5	6	300	0.707	0.636	0.283	3
TPSE476*035#0200	E	47	35	85	23	125	16.5	6	200	0.908	0.817	0.363	1 ¹⁾
TPSE476*035#0250	E	47	35	85	23	125	16.5	6	250	0.812	0.731	0.325	1 ¹⁾
TPSV476*035#0150	V	47	35	85	23	125	16.5	6	150	1.291	1.162	0.516	1 ¹⁾
TPSV476*035#0200	V	47	35	85	23	125	16.5	6	200	1.118	1.006	0.447	1 ¹⁾
TPSV686*035#0150	V	68	35	85	23	125	23.8	6	150	1.291	1.162	0.516	1 ¹⁾
TPSV686*035#0200	V	68	35	85	23	125	23.8	6	200	1.118	1.006	0.447	1 ¹⁾
50 Volt @ 85°C													
TPSA154*050#9000	A	0.15	50	85	33	125	0.5	4	9000	0.091	0.082	0.037	1
TPSA224*050#7000	A	0.22	50	85	33	125	0.5	4	7000	0.104	0.093	0.041	1
TPSA334*050#7000	A	0.33	50	85	33	125	0.5	4	7000	0.104	0.093	0.041	1
TPSA474*050#6500	A	0.47	50	85	33	125	0.5	4	6500	0.107	0.097	0.043	1
TPSB474*050#6000	B	0.47	50	85	33	125	0.5	4	6000	0.119	0.107	0.048	1
TPSC474*050#2300	C	0.47	50	85	33	125	0.5	4	2300	0.219	0.197	0.087	1
TPSB684*050#4000	B	0.68	50	85	33	125	0.5	4	4000	0.146	0.131	0.058	1
TPSB105*050#3000	B	1	50	85	33	125	0.5	6	3000	0.168	0.151	0.067	1
TPSC105*050#2500	C	1	50	85	33	125	0.5	4	2500	0.210	0.189	0.084	1
TPSC155*050#1500	C	1.5	50	85	33	125	0.8	6	1500	0.271	0.244	0.108	1
TPSC155*050#2000	C	1.5	50	85	33	125	0.8	6	2000	0.235	0.211	0.094	1
TPSC225*050#1500	C	2.2	50	85	33	125	1.1	8	1500	0.271	0.244	0.108	1
TPSD225*050#1200	D	2.2	50	85	33	125	1.1	6	1200	0.354	0.318	0.141	1
TPSC335*050#1000	C	3.3	50	85	33	125	1.6	6	1000	0.332	0.298	0.133	1
TPSD335*050#0800	D	3.3	50	85	33	125	1.7	6	800	0.433	0.390	0.173	1
TPSC475*050#0800	C	4.7	50	85	33	125	2.4	6	800	0.371	0.334	0.148	1
TPSD475*050#0250	D	4.7	50	85	33	125	2.4	6	250	0.775	0.697	0.310	1
TPSD475*050#0300	D	4.7	50	85	33	125	2.4	6	300	0.707	0.636	0.283	1
TPSD475*050#0500	D	4.7	50	85	33	125	2.4	6	500	0.548	0.493	0.219	1
TPSD475*050#0700	D	4.7	50	85	33	125	2.4	6	700	0.463	0.417	0.185	1
TPSX475*050#0500V	X	4.7	50	85	33	125	2.4	6	500	0.447	0.402	0.179	3
TPSD685*050#0200	D	6.8	50	85	33	125	3.4	6	200	0.866	0.779	0.346	1
TPSD685*050#0300	D	6.8	50	85	33	125	3.4	6	300	0.707	0.636	0.283	1
TPSD685*050#0500	D	6.8	50	85	33	125	3.4	6	500	0.548	0.493	0.219	1
TPSD685*050#0600	D	6.8	50	85	33	125	3.4	6	600	0.500	0.450	0.200	1
TPSD106*050#0500	D	10	50	85	33	125	5	6	500	0.548	0.493	0.219	1
TPSE106*050#0250	E	10	50	85	33	125	5	6	250	0.812	0.731	0.325	1 ¹⁾
TPSE106*050#0300	E	10	50	85	33	125	5	6	300	0.742	0.667	0.297	1 ¹⁾
TPSE106*050#0400	E	10	50	85	33	125	5	6	400	0.642	0.578	0.257	1 ¹⁾
TPSE106*050#0500	E	10	50	85	33	125	5	6	500	0.574	0.517	0.230	1 ¹⁾
TPSE156*050#0250	E	15	50	85	33	125	7.5	6	250	0.812	0.731	0.325	1 ¹⁾
TPSV156*050#0250	V	15	50	85	33	125	7.5	6	250	1.000	0.900	0.400	1 ¹⁾

1¹⁾ -Dry pack option (see How to order) is recommended for reduction of stress during soldering. Dry pack parts should be treated as MSL 3.

For AEC-Q200 availability, please contact AVX.

Moisture Sensitivity Level (MSL) is defined according to J-STD-020

All technical data relates to an ambient temperature of +25°C. Capacitance and DF are measured at 120Hz, 0.5V RMS with a maximum DC bias of 2.2 volts.

DCL is measured at rated voltage after 5 minutes.

The EIA & CECC standards for low ESR Solid Tantalum Capacitors allow an ESR movement to 1.25 times catalogue limit post mounting.

For typical weight and composition see page 274.

NOTE: AVX reserves the right to supply higher voltage ratings or tighter tolerance part in the same case size, to the same reliability standards.

QUALIFICATION TABLE

TEST	TPS series (Temperature range -55°C to +125°C)										
	Condition			Characteristics							
Endurance	Apply rated voltage (Ur) at 85°C and / or category voltage (Uc) at 125°C for 2000 hours through a circuit impedance of $\leq 0.1\Omega/V$. Stabilize at room temperature for 1-2 hours before measuring.			Visual examination	no visible damage						
				DCL	1.5 x initial limit						
				$\Delta C/C$	within $\pm 10\%$ of initial value						
				DF	initial limit						
				ESR	1.25 x initial limit						
Humidity	Store at 65°C and 95% relative humidity for 500 hours, with no applied voltage. Stabilize at room temperature and humidity for 1-2 hours before measuring.			Visual examination	no visible damage						
				DCL	1.5 x initial limit						
				$\Delta C/C$	within $\pm 10\%$ of initial value						
				DF	1.2 x initial limit						
				ESR	1.25 x initial limit						
Temperature Stability	Step	Temperature°C	Duration(min)		+20°C	-55°C	+20°C	+85°C	+125°C	+20°C	
	1	+20	15	DCL	IL*	n/a	IL*	10 x IL*	12.5 x IL*	IL*	
	2	-55	15	$\Delta C/C$	n/a	+0/-10%	$\pm 5\%$	+10/-0%	+12/-0%	$\pm 5\%$	
	3	+20	15	DF	IL*	1.5 x IL*	IL*	1.5 x IL*	2 x IL*	IL*	
	4	+85	15	ESR	1.25xIL*	2.5xIL*	1.25xIL*	1.25xIL*	1.25xIL*	1.25xIL*	
	5	+125	15								
6	+20	15									
Surge Voltage	Apply 1.3x category voltage (Uc) at 125°C for 1000 cycles of duration 6 min (30 sec charge, 5 min 30 sec discharge) through a charge / discharge resistance of 1000 Ω			Visual examination	no visible damage						
				DCL	initial limit						
				$\Delta C/C$	within $\pm 5\%$ of initial value						
				DF	initial limit						
				ESR	1.25 x initial limit						
Mechanical Shock	MIL-STD-202, Method 213, Condition C			Visual examination	no visible damage						
				DCL	initial limit						
				$\Delta C/C$	within $\pm 5\%$ of initial value						
				DF	initial limit						
				ESR	initial limit						
Vibration	MIL-STD-202, Method 204, Condition D			Visual examination	no visible damage						
				DCL	initial limit						
				$\Delta C/C$	within $\pm 5\%$ of initial value						
				DF	initial limit						
				ESR	initial limit						

*Initial Limit

AVX SOLID ELECTROLYTIC CAPACITOR ROADMAP

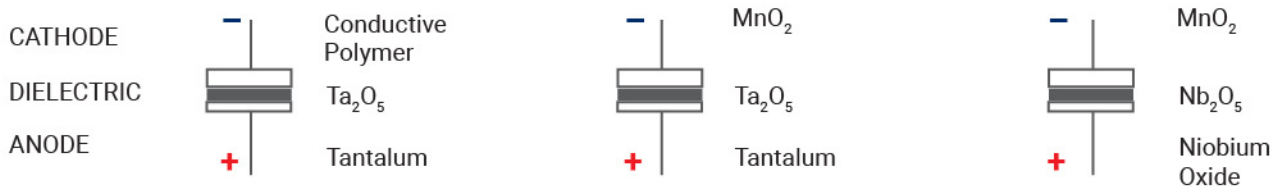
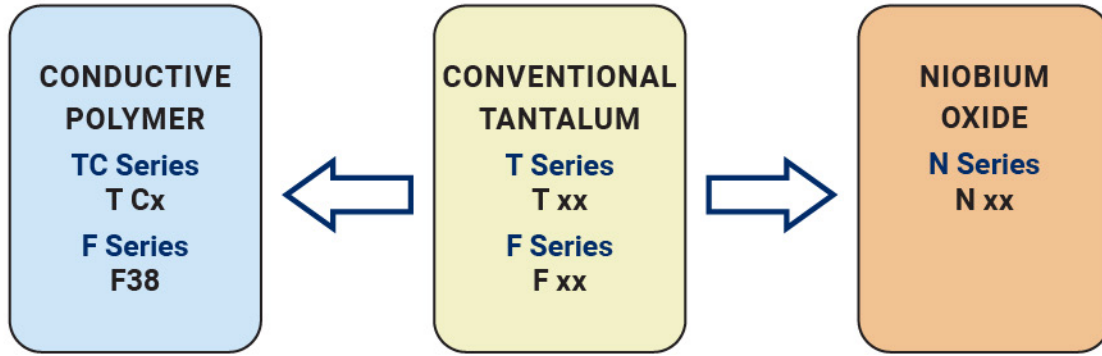

FIVE CAPACITOR CONSTRUCTION STYLES

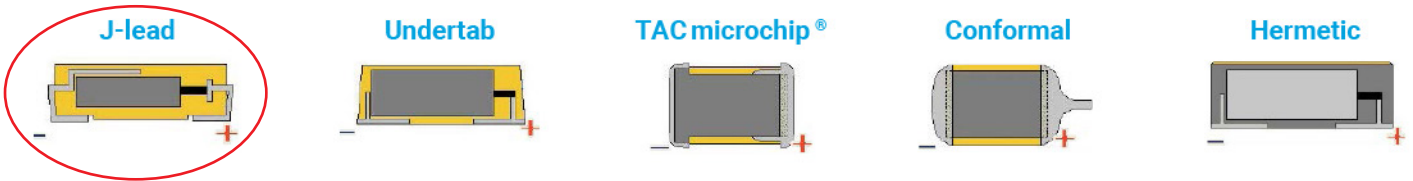

SERIES LINE UP : CONVENTIONAL SMD MnO₂

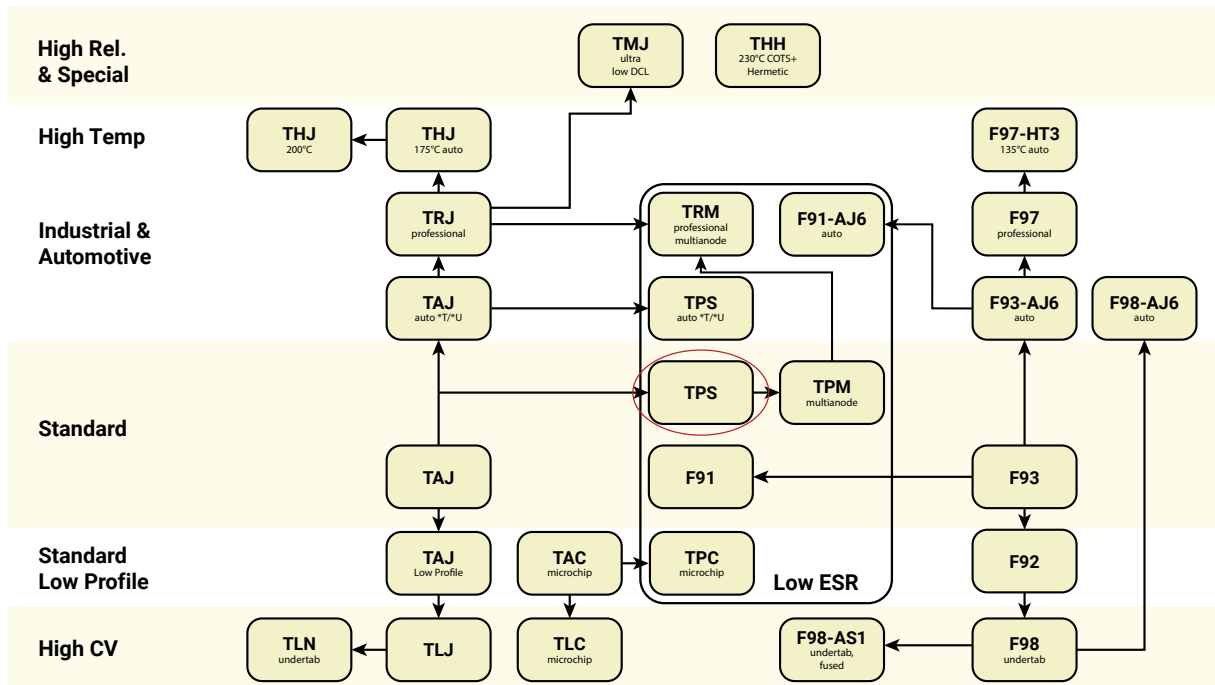

TPS Automotive Range

Low ESR - Automotive Product Range

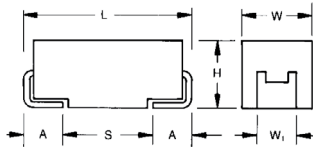
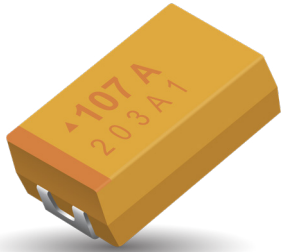

FEATURES

- Low ESR Series of Robust MnO₂ Solid Electrolyte Capacitors
- 100% Surge Current Tested
- CV Range: 0.22-680µF / 6.3-50V
- 5 Case Sizes Available
- Power Supply Applications

APPLICATIONS

- Power Supply
- Electric Window Control
- Battery Management Systems
- DC / DC Converter



MARKING

A, B, C, D, E CASE

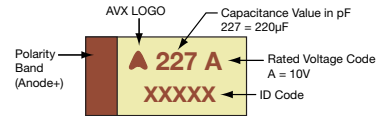

CASE DIMENSIONS:

millimeters (inches)

Code	EIA Code	EIA Metric	L±0.20 (0.008)	W+0.20 (0.008) -0.10 (0.004)	H+0.20 (0.008) -0.10 (0.004)	W ₁ ±0.20 (0.008)	A+0.30 (0.012) -0.20 (0.008)	S Min.
A	1206	3216-18	3.20 (0.126)	1.60 (0.063)	1.60 (0.063)	1.20 (0.047)	0.80 (0.031)	1.10 (0.043)
B	1210	3528-21	3.50 (0.138)	2.80 (0.110)	1.90 (0.075)	2.20 (0.087)	0.80 (0.031)	1.40 (0.055)
C	2312	6032-28	6.00 (0.236)	3.20 (0.126)	2.60 (0.102)	2.20 (0.087)	1.30 (0.051)	2.90 (0.114)
D	2917	7343-31	7.30 (0.287)	4.30 (0.169)	2.90 (0.114)	2.40 (0.094)	1.30 (0.051)	4.40 (0.173)
E	2917	7343-43	7.30 (0.287)	4.30 (0.169)	4.10 (0.162)	2.40 (0.094)	1.30 (0.051)	4.40 (0.173)

W₁ dimension applies to the termination width for A dimensional area only.

HOW TO ORDER

TPS	C	107	M	010	T	0150	V
Type	Case Size See table above	Capacitance Code pF code: 1st two digits represent significant figures, 3rd digit represents multiplier (number of zeros to follow)	Tolerance K = ±10% M = ±20%	Rated DC Voltage 006 = 6.3Vdc 010 = 10Vdc 016 = 16Vdc 020 = 20Vdc 025 = 25Vdc 035 = 35Vdc 050 = 50Vdc	Packaging T = Automotive Lead Free 7" Reel U = Automotive Lead Free 13" Reel	ESR in mΩ	Dry Pack Option (D,E case sizes mandatory)

TECHNICAL SPECIFICATIONS

Technical Data:	All technical data relate to an ambient temperature of +25°C								
Capacitance Range:	0.22 µF to 680 µF								
Capacitance Tolerance:	±10%; ±20%								
Rated Voltage (V _R)	≤ +85°C:	6.3	10	16	20	25	35	50	
Category Voltage (V _C)	≤ +125°C:	4	7	10	13	17	23	33	
Surge Voltage (V _S)	≤ +85°C:	8	13	20	26	32	46	65	
Surge Voltage (V _S)	≤ +125°C:	5	8	13	16	20	28	40	
Temperature Range:	-55°C to +125°C								
Environmental Classification:	55/125/56 (IEC 68-2)								
Reliability:	1% per 1000 hours at 85°C, V _R with 0.1Ω/V series impedance, 60% confidence level								
Termination Finished:	Sn Plating (standard), Gold and SnPb Plating upon request								
	Meets requirements of AEC-Q200								

TPS Automotive Range

Low ESR - Automotive Product Range



TPS AUTOMOTIVE RANGE CAPACITANCE AND RATED VOLTAGE RANGE (LETTER DENOTES CASE SIZE)

Capacitance		Rated Voltage DC (V _R) to 85°C						
µF	Code	6.3V (J)	10V (A)	16V (C)	20V (D)	25V (E)	35V (V)	50V (T)
0.15	154							
0.22	224							A(7000)
0.33	334						A(6000)	A(7000)
0.47	474					A(7000)	A(6000)	A(6500), B(6000)
0.68	684					A(6000)	A(6000)	B(4000)
1.0	105			A(6200)	A(3000)	A(4000)	A(3000), B(2000)	B(3000), C(2500)
1.5	155				A(3000)	A(3000)	A(3000), B(2500)	C(1500,2000)
2.2	225		A(1800)	A(1800,3500)	A(3000) B(1700)	A(2500) B(900,1200,2500)	B(750,1500,2000) C(1000)	C(1500) D(1200)
3.3	335	A(2100)		A(3500), B(2500)	A(2500), B(1300)	B(750,1500,2000)	B(1000), C(700)	C(1000), D(800)
4.7	475		A(1400) B(1400)	A(2000) B(800,1500)	A(1800) B(750,1000)	B(700,900) C(700)	B(700,1500), C(600) D(700)	C(800) D(250,500,700)
6.8	685		A(1800), B(1300)	A(1500), B(600,1200)	B(600,1000), C(700)	B(700), C(500,600,700)	C(350), D(400,500)	D(500,600)
10	106	A(1500), B(1500)	A(900,1800), B(1000)	A(1000), B(500,800) C(500)	B(500,1000) C(500,700)	B(1800), C(300,500) D(500)	C(600) D(300)	D(500) E(250,300,400,500)
15	156	A(700,1500)	A(1000), B(450,600) C(700)	B(500,800) C(300,700)	B(500) C(400,450)	C(220,300) D(300)	D(300)	E(250)
22	226	A(300,500,900) B(375,600), C(500)	A(900), B(400,500,700) C(180,300)	B(400,600), C(300,375) D(500), D(700)	B(400,600), C(400) D(200,300)	C(275,400) D(200,300)	D(200,300,400) E(200,300)	
33	336	A(600) B(250,350,450,600)	B(250,425,500,650) C(375,500)	B(500), C(150, 225,300) D(200)	C(300) D(160,200)	D(200,300)	D(200,300) E(250,300)	
47	476	B(250,350,500) C(300)	B(250,350,500,650) C(200,350), D(100,300)	C(350) D(100,200)	D(200)	D(125,150,250) E(125)	E(200,250)	
68	686	B(250,350,500) C(150,200)	C(200,300) D(150)	C(200) D(150)	D(150,200,300) E(125,150,200)	E(200)		
100	107	B(250,400) C(150), D(300)	C(100,150,200) D(100,125,150)	D(80,100,125,150) E(100,125,150)	E(100,150,200)	E(150)		
150	157	C(100,150,200,250) D(125)	D(85,100) E(100)	E(100)				
220	227	D(100,125)	D(100,150) E(70,100,125,150)	E(100,150)				
330	337	D(45,50,70,100) E(100,125,150)	E(50,60,100)					
470	477	D(45,60,100,200) E(45,50,60,100,200)						
680	687	E(45,60,100)						

Note for designers - for the highlighted ratings, higher voltage options are now available in the same case size and are recommended for new designs.

Released ratings, (ESR ratings in mOhms in parentheses)

Note: Voltage ratings are minimum values. AVX reserves the right to supply higher voltage ratings in the same case size, to the same reliability standards.

TPS Automotive Range

Low ESR - Automotive Product Range



RATINGS & PART NUMBER REFERENCE

AVX Part No.	Case Size	Capacitance (µF)	Rated Voltage (V)	Rated Temperature (°C)	Category Voltage (V)	Category Temperature (°C)	DCL Max. (µA)	DF Max. (%)	ESR Max. @ 100kHz (mΩ)	100kHz RMS Current (A)			MSL
										25°C	85°C	125°C	
6.3 Volt @ 85°C													
TPSA335*006T2100	A	3.3	6.3	85	4	125	0.5	6	2100	0.189	0.170	0.076	1
TPSA106*006T1500	A	10	6.3	85	4	125	0.6	6	1500	0.224	0.201	0.089	1
TPSB106*006T1500	B	10	6.3	85	4	125	0.6	6	1500	0.238	0.214	0.095	1
TPSA156*006T0700	A	15	6.3	85	4	125	0.9	6	700	0.327	0.295	0.131	1
TPSA156*006T1500	A	15	6.3	85	4	125	0.9	6	1500	0.224	0.201	0.089	1
TPSA226*006T0300	A	22	6.3	85	4	125	1.4	6	300	0.500	0.450	0.200	1
TPSA226*006T0500	A	22	6.3	85	4	125	1.4	6	500	0.387	0.349	0.155	1
TPSA226*006T0900	A	22	6.3	85	4	125	1.4	6	900	0.289	0.260	0.115	1
TPSB226*006T0375	B	22	6.3	85	4	125	1.4	6	375	0.476	0.428	0.190	1
TPSB226*006T0600	B	22	6.3	85	4	125	1.4	6	600	0.376	0.339	0.151	1
TPSC226*006T0500	C	22	6.3	85	4	125	1.4	6	500	0.469	0.422	0.188	1
TPSA336*006T0600	A	33	6.3	85	4	125	2.1	8	600	0.354	0.318	0.141	1
TPSB336*006T0250	B	33	6.3	85	4	125	2.1	6	250	0.583	0.525	0.233	1
TPSB336*006T0350	B	33	6.3	85	4	125	2.1	6	350	0.493	0.444	0.197	1
TPSB336*006T0450	B	33	6.3	85	4	125	2.1	6	450	0.435	0.391	0.174	1
TPSB336*006T0600	B	33	6.3	85	4	125	2.1	6	600	0.376	0.339	0.151	1
TPSB476*006T0250	B	47	6.3	85	4	125	3	6	250	0.583	0.525	0.233	1
TPSB476*006T0350	B	47	6.3	85	4	125	3	6	350	0.493	0.444	0.197	1
TPSB476*006T0500	B	47	6.3	85	4	125	3	6	500	0.412	0.371	0.165	1
TPSC476*006T0300	C	47	6.3	85	4	125	3	6	300	0.606	0.545	0.242	1
TPSB686*006T0250	B	68	6.3	85	4	125	4	8	250	0.583	0.525	0.233	1
TPSB686*006T0350	B	68	6.3	85	4	125	4	8	350	0.493	0.444	0.197	1
TPSB686*006T0500	B	68	6.3	85	4	125	4	8	500	0.412	0.371	0.165	1
TPSC686*006T0150	C	68	6.3	85	4	125	4.3	6	150	0.856	0.771	0.343	1
TPSC686*006T0200	C	68	6.3	85	4	125	4.3	6	200	0.742	0.667	0.297	1
TPSB107*006T0250	B	100	6.3	85	4	125	6.3	10	250	0.583	0.525	0.233	1
TPSB107*006T0400	B	100	6.3	85	4	125	6.3	10	400	0.461	0.415	0.184	1
TPSC107*006T0150	C	100	6.3	85	4	125	6.3	6	150	0.856	0.771	0.343	1
TPSD107*006T0300V	D	100	6.3	85	4	125	6.3	6	300	0.707	0.636	0.283	3
TPSC157*006T0100	C	150	6.3	85	4	125	9.5	6	100	1.049	0.944	0.420	1
TPSC157*006T0150	C	150	6.3	85	4	125	9.5	6	150	0.856	0.771	0.343	1
TPSC157*006T0200	C	150	6.3	85	4	125	9.5	6	200	0.742	0.667	0.297	1
TPSC157*006T0250	C	150	6.3	85	4	125	9.5	6	250	0.663	0.597	0.265	1
TPSD157*006T0125V	D	150	6.3	85	4	125	9.5	6	125	1.095	0.986	0.438	3
TPSD227*006T0100V	D	220	6.3	85	4	125	13.9	8	100	1.225	1.102	0.490	3
TPSD227*006T0125V	D	220	6.3	85	4	125	13.9	8	125	1.095	0.986	0.438	3
TPSD337*006T0045V	D	330	6.3	85	4	125	20.8	8	45	1.826	1.643	0.730	3
TPSD337*006T0050V	D	330	6.3	85	4	125	20.8	8	50	1.732	1.559	0.693	3
TPSD337*006T0070V	D	330	6.3	85	4	125	20.8	8	70	1.464	1.317	0.586	3
TPSD337*006T0100V	D	330	6.3	85	4	125	20.8	8	100	1.225	1.102	0.490	3
TPSE337*006T0100V	E	330	6.3	85	4	125	20.8	8	100	1.285	1.156	0.514	3
TPSE337*006T0125V	E	330	6.3	85	4	125	20.8	8	125	1.149	1.034	0.460	3
TPSE337*006T0150V	E	330	6.3	85	4	125	20.8	8	150	1.049	0.944	0.420	3
TPSD477*006T0045V	D	470	6.3	85	4	125	28	12	45	1.826	1.643	0.730	3
TPSD477*006T0060V	D	470	6.3	85	4	125	28	12	60	1.581	1.423	0.632	3
TPSD477*006T0100V	D	470	6.3	85	4	125	28	12	100	1.225	1.102	0.490	3
TPSD477*006T0200V	D	470	6.3	85	4	125	28	12	200	0.866	0.779	0.346	3
TPSE477*006T0045V	E	470	6.3	85	4	125	28	10	45	1.915	1.723	0.766	3
TPSE477*006T0050V	E	470	6.3	85	4	125	28	10	50	1.817	1.635	0.727	3
TPSE477*006T0060V	E	470	6.3	85	4	125	28	10	60	1.658	1.492	0.663	3
TPSE477*006T0100V	E	470	6.3	85	4	125	28	10	100	1.285	1.156	0.514	3
TPSE477*006T0200V	E	470	6.3	85	4	125	28	10	200	0.908	0.817	0.363	3
TPSE687*006T0045V	E	680	6.3	85	4	125	42.8	10	45	1.915	1.723	0.766	3
TPSE687*006T0060V	E	680	6.3	85	4	125	42.8	10	60	1.658	1.492	0.663	3
TPSE687*006T0100V	E	680	6.3	85	4	125	42.8	10	100	1.285	1.156	0.514	3
10 Volt @ 85°C													
TPSA225*010T1800	A	2.2	10	85	7	125	0.5	6	1800	0.204	0.184	0.082	1
TPSA475*010T1400	A	4.7	10	85	7	125	0.5	6	1400	0.231	0.208	0.093	1
TPSB475*010T1400	B	4.7	10	85	7	125	0.5	6	1400	0.246	0.222	0.099	1
TPSA685*010T1800	A	6.8	10	85	7	125	0.7	6	1800	0.204	0.184	0.082	1
TPSB685*010T1300	B	6.8	10	85	7	125	0.7	6	1300	0.256	0.230	0.102	1
TPSA106*010T0900	A	10	10	85	7	125	1	6	900	0.289	0.260	0.115	1
TPSA106*010T1800	A	10	10	85	7	125	1	6	1800	0.204	0.184	0.082	1
TPSB106*010T1000	B	10	10	85	7	125	1	6	1000	0.292	0.262	0.117	1
TPSA156*010T1000	A	15	10	85	7	125	1.5	6	1000	0.274	0.246	0.110	1
TPSB156*010T0450	B	15	10	85	7	125	1.5	6	450	0.435	0.391	0.174	1
TPSB156*010T0600	B	15	10	85	7	125	1.5	6	600	0.376	0.339	0.151	1
TPSC156*010T0700	C	15	10	85	7	125	1.5	6	700	0.396	0.357	0.159	1
TPSA226*010T0900	A	22	10	85	7	125	2.2	8	900	0.289	0.260	0.115	1
TPSB226*010T0400	B	22	10	85	7	125	2.2	6	400	0.461	0.415	0.184	1
TPSB226*010T0500	B	22	10	85	7	125	2.2	6	500	0.412	0.371	0.165	1
TPSB226*010T0700	B	22	10	85	7	125	2.2	6	700	0.348	0.314	0.139	1
TPSC226*010T0180	C	22	10	85	7	125	2.2	6	180	0.782	0.704	0.313	1
TPSC226*010T0300	C	22	10	85	7	125	2.2	6	300	0.606	0.545	0.242	1



The Important Information/Disclaimer is incorporated in the catalog where these specifications came from or available online at www.avx.com/disclaimer/ by reference and should be reviewed in full before placing any order.

TPS Automotive Range

Low ESR - Automotive Product Range



RATINGS & PART NUMBER REFERENCE

AVX Part No.	Case Size	Capacitance (µF)	Rated Voltage (V)	Rated Temperature (°C)	Category Voltage (V)	Category Temperature (°C)	DCL Max. (µA)	DF Max. (%)	ESR Max. @ 100kHz (mΩ)	100kHz RMS Current (A)			MSL
										25°C	85°C	125°C	
TPSB336*010T0250	B	33	10	85	7	125	3.3	6	250	0.583	0.525	0.233	1
TPSB336*010T0425	B	33	10	85	7	125	3.3	6	425	0.447	0.402	0.179	1
TPSB336*010T0500	B	33	10	85	7	125	3.3	6	500	0.412	0.371	0.165	1
TPSB336*010T0650	B	33	10	85	7	125	3.3	6	650	0.362	0.325	0.145	1
TPSC336*010T0375	C	33	10	85	7	125	3.3	6	375	0.542	0.487	0.217	1
TPSC336*010T0500	C	33	10	85	7	125	3.3	6	500	0.469	0.422	0.188	1
TPSB476*010T0250	B	47	10	85	7	125	4.7	8	250	0.583	0.525	0.233	1
TPSB476*010T0350	B	47	10	85	7	125	4.7	8	350	0.493	0.444	0.197	1
TPSB476*010T0500	B	47	10	85	7	125	4.7	8	500	0.412	0.371	0.165	1
TPSB476*010T0650	B	47	10	85	7	125	4.7	8	650	0.362	0.325	0.145	1
TPSC476*010T0200	C	47	10	85	7	125	4.7	6	200	0.742	0.667	0.297	1
TPSC476*010T0350	C	47	10	85	7	125	4.7	6	350	0.561	0.505	0.224	1
TPSD476*010T0100V	D	47	10	85	7	125	4.7	6	100	1.225	1.102	0.490	3
TPSD476*010T0300V	D	47	10	85	7	125	4.7	6	300	0.707	0.636	0.283	3
TPSC686*010T0200	C	68	10	85	7	125	6.8	6	200	0.742	0.667	0.297	1
TPSC686*010T0300	C	68	10	85	7	125	6.8	6	300	0.606	0.545	0.242	1
TPSD686*010T0150V	D	68	10	85	7	125	6.8	6	150	1.000	0.900	0.400	3
TPSC107*010T0100	C	100	10	85	7	125	10	8	100	1.049	0.944	0.420	1
TPSC107*010T0150	C	100	10	85	7	125	10	8	150	0.856	0.771	0.343	1
TPSC107*010T0200	C	100	10	85	7	125	10	8	200	0.742	0.667	0.297	1
TPSD107*010T0100V	D	100	10	85	7	125	10	6	100	1.225	1.102	0.490	3
TPSD107*010T0125V	D	100	10	85	7	125	10	6	125	1.095	0.986	0.438	3
TPSD107*010T0150V	D	100	10	85	7	125	10	6	150	1.000	0.900	0.400	3
TPSD157*010T0085V	D	150	10	85	7	125	15	8	85	1.328	1.196	0.531	3
TPSD157*010T0100V	D	150	10	85	7	125	15	8	100	1.225	1.102	0.490	3
TPSE157*010T0100V	E	150	10	85	7	125	15	8	100	1.285	1.156	0.514	3
TPSD227*010T0100V	D	220	10	85	7	125	22	8	100	1.225	1.102	0.490	3
TPSD227*010T0150V	D	220	10	85	7	125	22	8	150	1.000	0.900	0.400	3
TPSE227*010T0070V	E	220	10	85	7	125	22	8	70	1.535	1.382	0.614	3
TPSE227*010T0100V	E	220	10	85	7	125	22	8	100	1.285	1.156	0.514	3
TPSE227*010T0125V	E	220	10	85	7	125	22	8	125	1.149	1.034	0.460	3
TPSE227*010T0150V	E	220	10	85	7	125	22	8	150	1.049	0.944	0.420	3
TPSE337*010T0050V	E	330	10	85	7	125	33	8	50	1.817	1.635	0.727	3
TPSE337*010T0060V	E	330	10	85	7	125	33	8	60	1.658	1.492	0.663	3
TPSE337*010T0100V	E	330	10	85	7	125	33	8	100	1.285	1.156	0.514	3
16 Volt @ 85°C													
TPSA105*016T6200	A	1.0	16	85	10	125	0.5	4	6200	0.110	0.099	0.044	1
TPSA225*016T1800	A	2.2	16	85	10	125	0.5	6	1800	0.204	0.184	0.082	1
TPSA225*016T3500	A	2.2	16	85	10	125	0.5	6	3500	0.146	0.132	0.059	1
TPSA335*016T3500	A	3.3	16	85	10	125	0.5	6	3500	0.146	0.132	0.059	1
TPSB335*016T2500	B	3.3	16	85	10	125	0.5	6	2500	0.184	0.166	0.074	1
TPSA475*016T2000	A	4.7	16	85	10	125	0.8	6	2000	0.194	0.174	0.077	1
TPSB475*016T0800	B	4.7	16	85	10	125	0.8	6	800	0.326	0.293	0.130	1
TPSB475*016T1500	B	4.7	16	85	10	125	0.8	6	1500	0.238	0.214	0.095	1
TPSA685*016T1500	A	6.8	16	85	10	125	1.1	6	1500	0.224	0.201	0.089	1
TPSB685*016T0600	B	6.8	16	85	10	125	1.1	6	600	0.376	0.339	0.151	1
TPSB685*016T1200	B	6.8	16	85	10	125	1.1	6	1200	0.266	0.240	0.106	1
TPSA106*016T1000	A	10	16	85	10	125	1.6	6	1000	0.274	0.246	0.110	1
TPSB106*016T0500	B	10	16	85	10	125	1.6	6	500	0.412	0.371	0.165	1
TPSB106*016T0800	B	10	16	85	10	125	1.6	6	800	0.326	0.293	0.130	1
TPSC106*016T0500	C	10	16	85	10	125	1.6	6	500	0.469	0.422	0.188	1
TPSB156*016T0500	B	15	16	85	10	125	2.4	6	500	0.412	0.371	0.165	1
TPSB156*016T0800	B	15	16	85	10	125	2.4	6	800	0.326	0.293	0.130	1
TPSC156*016T0300	C	15	16	85	10	125	2.4	6	300	0.606	0.545	0.242	1
TPC156*016T0700	C	15	16	85	10	125	2.4	6	700	0.396	0.357	0.159	1
TPSB226*016T0400	B	22	16	85	10	125	3.5	6	400	0.461	0.415	0.184	1
TPSB226*016T0600	B	22	16	85	10	125	3.5	6	600	0.376	0.339	0.151	1
TPSC226*016T0300	C	22	16	85	10	125	3.5	6	300	0.606	0.545	0.242	1
TPSC226*016T0375	C	22	16	85	10	125	3.5	6	375	0.542	0.487	0.217	1
TPSD226*016T0500V	D	22	16	85	10	125	3.5	6	500	0.548	0.493	0.219	3
TPSD226*016T0700V	D	22	16	85	10	125	3.5	6	700	0.463	0.417	0.185	3
TPSB336*016T0500	B	33	16	85	10	125	5.3	8	500	0.412	0.371	0.165	1
TPSC336*016T0150	C	33	16	85	10	125	5.3	6	150	0.856	0.771	0.343	1
TPSC336*016T0225	C	33	16	85	10	125	5.3	6	225	0.699	0.629	0.280	1
TPSC336*016T0300	C	33	16	85	10	125	5.3	6	300	0.606	0.545	0.242	1
TPSD336*016T0200V	D	33	16	85	10	125	5.3	6	200	0.866	0.779	0.346	3
TPSC476*016T0350	C	47	16	85	10	125	7.5	6	350	0.561	0.505	0.224	1
TPSD476*016T0100V	D	47	16	85	10	125	7.5	6	100	1.225	1.102	0.490	3
TPSD476*016T0200V	D	47	16	85	10	125	7.5	6	200	0.866	0.779	0.346	3
TPSC686*016T0200	C	68	16	85	10	125	10.9	6	200	0.742	0.667	0.297	1
TPSD686*016T0150V	D	68	16	85	10	125	10.9	6	150	1.000	0.900	0.400	3
TPSD107*016T0080V	D	100	16	85	10	125	16	6	80	1.369	1.232	0.548	3
TPSD107*016T0100V	D	100	16	85	10	125	16	6	100	1.225	1.102	0.490	3
TPSD107*016T0125V	D	100	16	85	10	125	16	6	125	1.095	0.986	0.438	3
TPSD107*016T0150V	D	100	16	85	10	125	16	6	150	1.000	0.900	0.400	3
TPSE107*016T0100V	E	100	16	85	10	125	16	6	100	1.285	1.156	0.514	3



TPS Automotive Range

Low ESR - Automotive Product Range



RATINGS & PART NUMBER REFERENCE

AVX Part No.	Case Size	Capacitance (µF)	Rated Voltage (V)	Rated Temperature (°C)	Category Voltage (V)	Category Temperature (°C)	DCL Max. (µA)	DF Max. (%)	ESR Max. @ 100kHz (mΩ)	100kHz RMS Current (A)			MSL
										25°C	85°C	125°C	
TPSE107*016T0125V	E	100	16	85	10	125	16	6	125	1.149	1.034	0.460	3
TPSE107*016T0150V	E	100	16	85	10	125	16	6	150	1.049	0.944	0.420	3
TPSE157*016T0100V	E	150	16	85	10	125	24	8	100	1.285	1.156	0.514	3
TPSE227*016T0100V	E	220	16	85	10	125	35.2	10	100	1.285	1.156	0.514	3
TPSE227*016T0150V	E	220	16	85	10	125	35.2	10	150	1.049	0.944	0.420	3
20 Volt @ 85°C													
TPSA105*020T3000	A	1	20	85	13	125	0.5	4	3000	0.158	0.142	0.063	1
TPSA155*020T3000	A	1.5	20	85	13	125	0.5	6	3000	0.158	0.142	0.063	1
TPSA225*020T3000	A	2.2	20	85	13	125	0.5	6	3000	0.158	0.142	0.063	1
TPSB225*020T1700	B	2.2	20	85	13	125	0.5	6	1700	0.224	0.201	0.089	1
TPSA335*020T2500	A	3.3	20	85	13	125	0.7	6	2500	0.173	0.156	0.069	1
TPSB335*020T1300	B	3.3	20	85	13	125	0.7	6	1300	0.256	0.230	0.102	1
TPSA475*020T1800	A	4.7	20	85	13	125	0.9	6	1800	0.204	0.184	0.082	1
TPSB475*020T0750	B	4.7	20	85	13	125	0.9	6	750	0.337	0.303	0.135	1
TPSB475*020T1000	B	4.7	20	85	13	125	0.9	6	1000	0.292	0.262	0.117	1
TPSB685*020T0600	B	6.8	20	85	13	125	1.4	6	600	0.376	0.339	0.151	1
TPSB685*020T1000	B	6.8	20	85	13	125	1.4	6	1000	0.292	0.262	0.117	1
TPSC685*020T0700	C	6.8	20	85	13	125	1.4	6	700	0.396	0.357	0.159	1
TPSB106*020T0500	B	10	20	85	13	125	2	6	500	0.412	0.371	0.165	1
TPSB106*020T1000	B	10	20	85	13	125	2	6	1000	0.292	0.262	0.117	1
TPSC106*020T0500	C	10	20	85	13	125	2	6	500	0.469	0.422	0.188	1
TPSC106*020T0700	C	10	20	85	13	125	2	6	700	0.396	0.357	0.159	1
TPSB156*020T0500	B	15	20	85	13	125	3	6	500	0.412	0.371	0.165	1
TPSC156*020T0400	C	15	20	85	13	125	3	6	400	0.524	0.472	0.210	1
TPSC156*020T0450	C	15	20	85	13	125	3	6	450	0.494	0.445	0.198	1
TPSB226*020T0400	B	22	20	85	13	125	4.4	6	400	0.461	0.415	0.184	1
TPSB226*020T0600	B	22	20	85	13	125	4.4	6	600	0.376	0.339	0.151	1
TPSC226*020T0400	C	22	20	85	13	125	4.4	6	400	0.524	0.472	0.210	1
TPSD226*020T0200V	D	22	20	85	13	125	4.4	6	200	0.866	0.779	0.346	3
TPSD226*020T0300V	D	22	20	85	13	125	4.4	6	300	0.707	0.636	0.283	3
TPSC336*020T0300	C	33	20	85	13	125	6.6	6	300	0.606	0.545	0.242	1
TPSD336*020T0160V	D	33	20	85	13	125	6.6	6	160	0.968	0.871	0.387	3
TPSD336*020T0200V	D	33	20	85	13	125	6.6	6	200	0.866	0.779	0.346	3
TPSD476*020T0200V	D	47	20	85	13	125	9.4	6	200	0.866	0.779	0.346	3
TPSD686*020T0150V	D	68	20	85	13	125	13.6	6	150	1.000	0.900	0.400	3
TPSD686*020T0200V	D	68	20	85	13	125	13.6	6	200	0.866	0.779	0.346	3
TPSD686*020T0300V	D	68	20	85	13	125	13.6	6	300	0.707	0.636	0.283	3
TPSE686*020T0125V	E	68	20	85	13	125	13.6	6	125	1.149	1.034	0.460	3
TPSE686*020T0150V	E	68	20	85	13	125	13.6	6	150	1.049	0.944	0.420	3
TPSE686*020T0200V	E	68	20	85	13	125	13.6	6	200	0.908	0.817	0.363	3
TPSE107*020T0100V	E	100	20	85	13	125	20	6	100	1.285	1.156	0.514	3
TPSE107*020T0150V	E	100	20	85	13	125	20	6	150	1.049	0.944	0.420	3
TPSE107*020T0200V	E	100	20	85	13	125	20	6	200	0.908	0.817	0.363	3
25 Volt @ 85°C													
TPSA474*025T7000	A	0.47	25	85	17	125	0.5	4	7000	0.104	0.093	0.041	1
TPSA684*025T6000	A	0.68	25	85	17	125	0.5	4	6000	0.112	0.101	0.045	1
TPSA105*025T4000	A	1.0	25	85	17	125	0.5	4	4000	0.137	0.123	0.055	1
TPSA155*025T3000	A	1.5	25	85	17	125	0.5	6	3000	0.158	0.142	0.063	1
TPSA225*025T2500	A	2.2	25	85	17	125	0.6	6	2500	0.173	0.156	0.069	1
TPSB225*025T0900	B	2.2	25	85	17	125	0.6	6	900	0.307	0.277	0.123	1
TPSB225*025T1200	B	2.2	25	85	17	125	0.6	6	1200	0.266	0.240	0.106	1
TPSB225*025T2500	B	2.2	25	85	17	125	0.6	6	2500	0.184	0.166	0.074	1
TPSB335*025T0750	B	3.3	25	85	17	125	0.8	6	750	0.337	0.303	0.135	1
TPSB335*025T1500	B	3.3	25	85	17	125	0.8	6	1500	0.238	0.214	0.095	1
TPSB335*025T2000	B	3.3	25	85	17	125	0.8	6	2000	0.206	0.186	0.082	1
TPSB475*025T0700	B	4.7	25	85	17	125	1.2	6	700	0.348	0.314	0.139	1
TPSB475*025T0900	B	4.7	25	85	17	125	1.2	6	900	0.307	0.277	0.123	1
TPSC475*025T0700	C	4.7	25	85	17	125	1.2	6	700	0.396	0.357	0.159	1
TPSB685*025T0700	B	6.8	25	85	17	125	1.7	6	700	0.348	0.314	0.139	1
TPSC685*025T0500	C	6.8	25	85	17	125	1.7	6	500	0.469	0.422	0.188	1
TPSC685*025T0600	C	6.8	25	85	17	125	1.7	6	600	0.428	0.385	0.171	1
TPSC685*025T0700	C	6.8	25	85	17	125	1.7	6	700	0.396	0.357	0.159	1
TPSB106*025T1800	B	10	25	85	17	125	2.5	6	1800	0.217	0.196	0.087	1
TPSC106*025T0300	C	10	25	85	17	125	2.5	6	300	0.606	0.545	0.242	1
TPSC106*025T0500	C	10	25	85	17	125	2.5	6	500	0.469	0.422	0.188	1
TPSD106*025T0500V	D	10	25	85	17	125	2.5	6	500	0.548	0.493	0.219	3
TPSC156*025T0220	C	15	25	85	17	125	3.8	6	220	0.707	0.636	0.283	1
TPSC156*025T0300	C	15	25	85	17	125	3.8	6	300	0.606	0.545	0.242	1
TPSD156*025T0300V	D	15	25	85	17	125	3.8	6	300	0.707	0.636	0.283	3
TPSC226*025T0275	C	22	25	85	17	125	5.5	6	275	0.632	0.569	0.253	1
TPSC226*025T0400	C	22	25	85	17	125	5.5	6	400	0.524	0.472	0.210	1
TPSD226*025T0200V	D	22	25	85	17	125	5.5	6	200	0.866	0.779	0.346	3
TPSD226*025T0300V	D	22	25	85	17	125	5.5	6	300	0.707	0.636	0.283	3
TPSD336*025T0200V	D	33	25	85	17	125	8.3	6	200	0.866	0.779	0.346	3
TPSD336*025T0300V	D	33	25	85	17	125	8.3	6	300	0.707	0.636	0.283	3
TPSD476*025T0125V	D	47	25	85	17	125	11.8	6	125	1.095	0.986	0.438	3



The Important Information/Disclaimer is incorporated in the catalog where these specifications came from or available online at www.avx.com/disclaimer/ by reference and should be reviewed in full before placing any order.

TPS Automotive Range

Low ESR - Automotive Product Range



RATINGS & PART NUMBER REFERENCE

AVX Part No.	Case Size	Capacitance (µF)	Rated Voltage (V)	Rated Temperature (°C)	Category Voltage (V)	Category Temperature (°C)	DCL Max. (µA)	DF Max. (%)	ESR Max. @ 100kHz (mΩ)	100kHz RMS Current (A)			MSL
										25°C	85°C	125°C	
TPSD476*025T0150V	D	47	25	85	17	125	11.8	6	150	1.000	0.900	0.400	3
TPSD476*025T0250V	D	47	25	85	17	125	11.8	6	250	0.775	0.697	0.310	3
TPSE476*025T0125V	E	47	25	85	17	125	11.8	6	125	1.149	1.034	0.460	3
TPSE686*025T0200V	E	68	25	85	17	125	17	6	200	0.908	0.817	0.363	3
TPSE107*025T0150V	E	100	25	85	17	125	25	10	150	1.049	0.944	0.420	3
35 Volt @ 85°C													
TPSA334*035T6000	A	0.33	35	85	23	125	0.5	4	6000	0.112	0.101	0.045	1
TPSA474*035T6000	A	0.47	35	85	23	125	0.5	4	6000	0.112	0.101	0.045	1
TPSA684*035T6000	A	0.68	35	85	23	125	0.5	4	6000	0.112	0.101	0.045	1
TPSA105*035T3000	A	1	35	85	23	125	0.5	4	3000	0.158	0.142	0.063	1
TPSB105*035T2000	B	1	35	85	23	125	0.5	4	2000	0.206	0.186	0.082	1
TPSA155*035T3000	A	1.5	35	85	23	125	0.5	6	3000	0.158	0.142	0.063	1
TPSB155*035T2500	B	1.5	35	85	23	125	0.5	6	2500	0.184	0.166	0.074	1
TPSB225*035T0750	B	2.2	35	85	23	125	0.8	6	750	0.337	0.303	0.135	1
TPSB225*035T1500	B	2.2	35	85	23	125	0.8	6	1500	0.238	0.214	0.095	1
TPSB225*035T2000	B	2.2	35	85	23	125	0.8	6	2000	0.206	0.186	0.082	1
TPSC225*035T1000	C	2.2	35	85	23	125	0.8	6	1000	0.332	0.298	0.133	1
TPSB335*035T1000	B	3.3	35	85	23	125	1.2	6	1000	0.292	0.262	0.117	1
TPSC335*035T0700	C	3.3	35	85	23	125	1.2	6	700	0.396	0.357	0.159	1
TPSB475*035T0700	B	4.7	35	85	23	125	1.6	6	700	0.348	0.314	0.139	1
TPSB475*035T1500	B	4.7	35	85	23	125	1.6	6	1500	0.238	0.214	0.095	1
TPSC475*035T0600	C	4.7	35	85	23	125	1.6	6	600	0.428	0.385	0.171	1
TPSD475*035T0700V	D	4.7	35	85	23	125	1.6	6	700	0.463	0.417	0.185	3
TPSC685*035T0350	C	6.8	35	85	23	125	2.4	6	350	0.561	0.505	0.224	1
TPSD685*035T0400V	D	6.8	35	85	23	125	2.4	6	400	0.612	0.551	0.245	3
TPSD685*035T0500V	D	6.8	35	85	23	125	2.4	6	500	0.548	0.493	0.219	3
TPSC106*035T0600	C	10	35	85	23	125	3.5	6	600	0.428	0.385	0.171	1
TPSD106*035T0300V	D	10	35	85	23	125	3.5	6	300	0.707	0.636	0.283	3
TPSD156*035T0300V	D	15	35	85	23	125	5.3	6	300	0.707	0.636	0.283	3
TPSD226*035T0200V	D	22	35	85	23	125	7.7	6	200	0.866	0.779	0.346	3
TPSD226*035T0300V	D	22	35	85	23	125	7.7	6	300	0.707	0.636	0.283	3
TPSD226*035T0400V	D	22	35	85	23	125	7.7	6	400	0.612	0.551	0.245	3
TPSE226*035T0200V	E	22	35	85	23	125	7.7	6	200	0.908	0.817	0.363	3
TPSE226*035T0300V	E	22	35	85	23	125	7.7	6	300	0.742	0.667	0.297	3
TPSD336*035T0200V	D	33	35	85	23	125	11.6	6	200	0.866	0.779	0.346	3
TPSD336*035T0300V	D	33	35	85	23	125	11.6	6	300	0.707	0.636	0.283	3
TPSE336*035T0250V	E	33	35	85	23	125	11.6	6	250	0.812	0.731	0.325	3
TPSE336*035T0300V	E	33	35	85	23	125	11.6	6	300	0.742	0.667	0.297	3
TPSE476*035T0200V	E	47	35	85	23	125	16.5	6	200	0.908	0.817	0.363	3
TPSE476*035T0250V	E	47	35	85	23	125	16.5	6	250	0.812	0.731	0.325	3
50 Volt @ 85°C													
TPSA224*050T7000	A	0.22	50	85	33	125	0.5	4	7000	0.104	0.093	0.041	1
TPSA334*050T7000	A	0.33	50	85	33	125	0.5	4	7000	0.104	0.093	0.041	1
TPSA474*050T6500	A	0.47	50	85	33	125	0.5	4	6500	0.107	0.097	0.043	1
TPSB474*050T6000	B	0.47	50	85	33	125	0.5	4	6000	0.119	0.107	0.048	1
TPSB684*050T4000	B	0.68	50	85	33	125	0.5	4	4000	0.146	0.131	0.058	1
TPSB105*050T3000	B	1	50	85	33	125	0.5	6	3000	0.168	0.151	0.067	1
TPSC105*050T2500	C	1	50	85	33	125	0.5	4	2500	0.210	0.189	0.084	1
TPSC155*050T1500	C	1.5	50	85	33	125	0.8	6	1500	0.271	0.244	0.108	1
TPSC155*050T2000	C	1.5	50	85	33	125	0.8	6	2000	0.235	0.211	0.094	1
TPSC225*050T1500	C	2.2	50	85	33	125	1.1	8	1500	0.271	0.244	0.108	1
TPSD225*050T1200V	D	2.2	50	85	33	125	1.1	6	1200	0.354	0.318	0.141	3
TPSC335*050T1000	C	3.3	50	85	33	125	1.6	6	1000	0.332	0.298	0.133	1
TPSD335*050T0800V	D	3.3	50	85	33	125	1.7	6	800	0.433	0.390	0.173	3
TPSC475*050T0800	C	4.7	50	85	33	125	2.4	6	800	0.371	0.334	0.148	1
TPSD475*050T0250V	D	4.7	50	85	33	125	2.4	6	250	0.775	0.697	0.310	1
TPSD475*050T0500V	D	4.7	50	85	33	125	2.4	6	500	0.548	0.493	0.219	3
TPSD475*050T0700V	D	4.7	50	85	33	125	2.4	6	700	0.463	0.417	0.185	3
TPSD685*050T0500V	D	6.8	50	85	33	125	3.4	6	500	0.548	0.493	0.219	3
TPSD685*050T0600V	D	6.8	50	85	33	125	3.4	6	600	0.500	0.450	0.200	3
TPSD106*050T0500V	D	10	50	85	33	125	5	6	500	0.548	0.493	0.219	3
TPSE106*050T0250V	E	10	50	85	33	125	5	6	250	0.812	0.731	0.325	3
TPSE106*050T0300V	E	10	50	85	33	125	5	6	300	0.742	0.667	0.297	3
TPSE106*050T0400V	E	10	50	85	33	125	5	6	400	0.642	0.578	0.257	3
TPSE106*050T0500V	E	10	50	85	33	125	5	6	500	0.574	0.517	0.230	3
TPSE156*050T0250V	E	15	50	85	33	125	7.5	6	250	0.812	0.731	0.325	3

Moisture Sensitivity Level (MSL) is defined according to J-STD-020

*Please use "U" instead of "T" in the suffix letter for 13" reel packaging

Please use specific PN for automotive version - see "HOW TO ORDER".

All technical data relates to an ambient temperature of +25°C. Capacitance and DF are measured at 120Hz, 0.5V RMS with a maximum DC bias of 2.2 volts.

DCL is measured at rated voltage after 5 minutes.

The EIA & CECC standards for low ESR Solid Tantalum Capacitors allow an ESR movement to 1.25 times catalogue limit post mounting.

For typical weight and composition see page 274.

NOTE: AVX reserves the right to supply higher voltage ratings or tighter tolerance part in the same case size, to the same reliability standards.

TPS Automotive Range

Low ESR - Automotive Product Range

QUALIFICATION TABLE

TEST	TPS automotive series (Temperature range -55°C to +125°C)									
	Condition			Characteristics						
Endurance	Apply rated voltage (Ur) at 85°C and / or category voltage (Uc) at 125°C for 2000 hours through a circuit impedance of $\leq 0.1\Omega/V$. Stabilize at room temperature for 1-2 hours before measuring.			Visual examination	no visible damage					
				DCL	1.25 x initial limit					
				$\Delta C/C$	within $\pm 10\%$ of initial value					
				DF	initial limit					
				ESR	1.25 x initial limit					
Storage Life	Store at 125°C, no voltage applied, for 2000 hours. Stabilize at room temperature for 1-2 hours before measuring.			Visual examination	no visible damage					
				DCL	1.25 x initial limit					
				$\Delta C/C$	within $\pm 10\%$ of initial value					
				DF	initial limit					
				ESR	1.25 x initial limit					
Humidity	Store at 65°C and 95% relative humidity for 500 hours, with no applied voltage. Stabilize at room temperature and humidity for 1-2 hours before measuring.			Visual examination	no visible damage					
				DCL	1.5 x initial limit					
				$\Delta C/C$	within $\pm 10\%$ of initial value					
				DF	1.2 x initial limit					
				ESR	1.25 x initial limit					
Biased Humidity	Apply rated voltage (Ur) at 85°C, 85% relative humidity for 1000 hours. Stabilize at room temperature and humidity for 1-2 hours before measuring.			Visual examination	no visible damage					
				DCL	2 x initial limit					
				$\Delta C/C$	within $\pm 10\%$ of initial value					
				DF	1.2 x initial limit					
				ESR	1.25 x initial limit					
Temperature Stability	Step	Temperature°C	Duration(min)		+20°C	-55°C	+20°C	+85°C	+125°C	+20°C
	1	+20	15	DCL	IL*	n/a	IL*	10 x IL*	12.5 x IL*	IL*
	2	-55	15	$\Delta C/C$	n/a	+0/-10%	$\pm 5\%$	+10/-0%	+12/-0%	$\pm 5\%$
	3	+20	15	DF	IL*	1.5 x IL*	IL*	1.5 x IL*	2 x IL*	IL*
	4	+85	15							
	5	+125	15	ESR	125xIL*	25xIL*	125xIL*	125xIL*	125xIL*	125xIL*
	6	+20	15							
Surge Voltage	Apply 1.3x category voltage (Uc) at 125°C for 1000 cycles of duration 6 min (30 sec charge, 5 min 30 sec discharge) through a charge / discharge resistance of 1000 Ω			Visual examination	no visible damage					
				DCL	initial limit					
				$\Delta C/C$	within $\pm 5\%$ of initial value					
				DF	initial limit					
				ESR	1.25 x initial limit					
Mechanical Shock	MIL-STD-202, Method 213, Condition F			Visual examination	no visible damage					
				DCL	initial limit					
				$\Delta C/C$	within $\pm 5\%$ of initial value					
				DF	initial limit					
				ESR	1.25 x initial limit					
Vibration	MIL-STD-202, Method 204, Condition D			Visual examination	no visible damage					
				DCL	initial limit					
				$\Delta C/C$	within $\pm 5\%$ of initial value					
				DF	initial limit					
				ESR	1.25 x initial limit					

*Initial Limit

AVX SOLID ELECTROLYTIC CAPACITOR ROADMAP

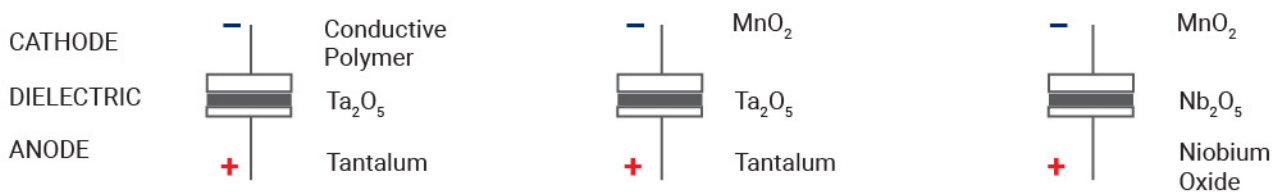
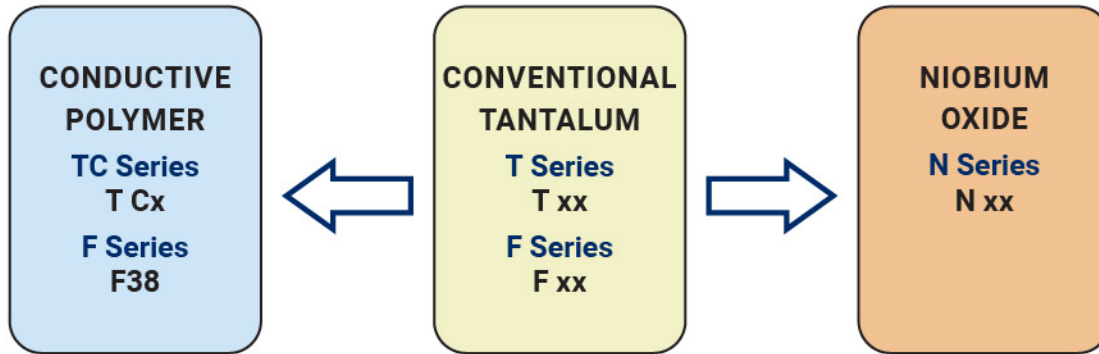

FIVE CAPACITOR CONSTRUCTION STYLES

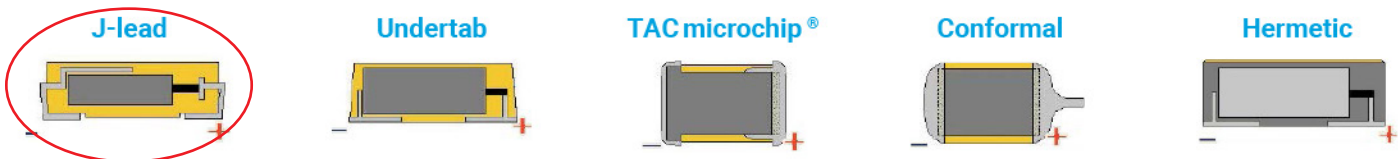

SERIES LINE UP : CONVENTIONAL SMD MnO₂

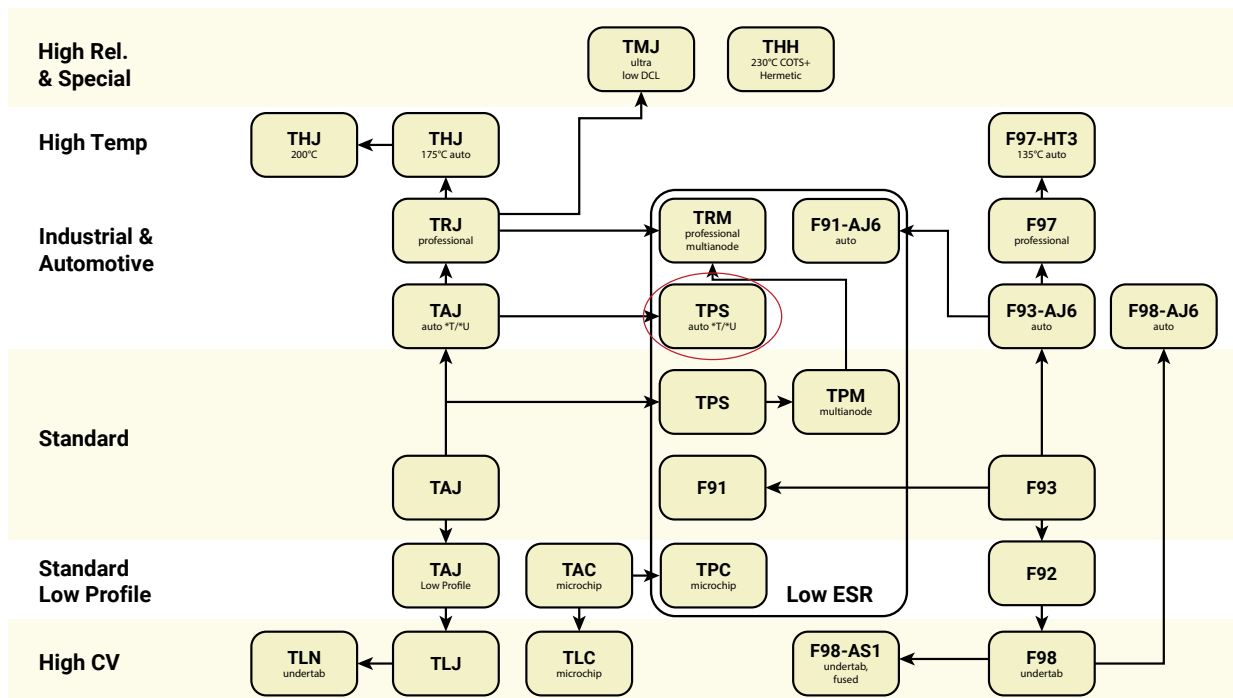

F91 Series

Low ESR, Resin-Molded Chip J-Lead



FEATURES

- Compliant to the RoHS3 directive 2015/863/EU
- SMD J-Lead
- Low ESR
- 100% Surge Current Tested

APPLICATIONS

- General Medium Power DC/DC Convertors



CASE DIMENSIONS:

millimeters (inches)

Code	EIA Code	EIA Metric	L	W ₁	W ₂	H	S
B	1210	3528-21	3.50 ± 0.20 (0.138 ± 0.008)	2.80 ± 0.20 (0.110 ± 0.008)	2.20 ± 0.10 (0.087 ± 0.004)	1.90 ± 0.20 (0.075 ± 0.008)	0.80 ± 0.20 (0.031 ± 0.008)
C	2312	6032-27	6.00 ± 0.20 (0.236 ± 0.008)	3.20 ± 0.20 (0.126 ± 0.008)	2.20 ± 0.10 (0.087 ± 0.004)	2.50 ± 0.20 (0.098 ± 0.008)	1.30 ± 0.20 (0.051 ± 0.008)
N	2917	7343-30	7.30 ± 0.20 (0.287 ± 0.008)	4.30 ± 0.20 (0.169 ± 0.008)	2.40 ± 0.10 (0.094 ± 0.004)	2.80 ± 0.20 (0.110 ± 0.008)	1.30 ± 0.20 (0.051 ± 0.008)

B CASE

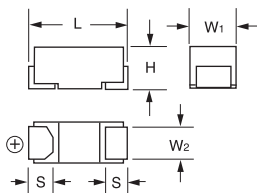

C, N CASE

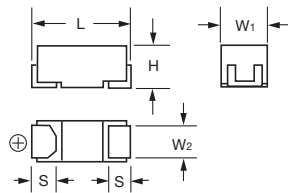

MARKING

B CASE

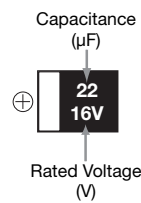

C CASE

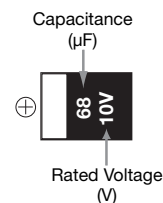

N CASE

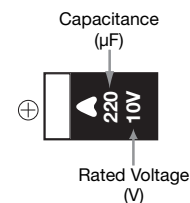

HOW TO ORDER

F91

Type

1A

Rated Voltage

107

Capacitance Code
pF code: 1st two digits represent significant figures, 3rd digit represents multiplier (number of zeros to follow)

M

Tolerance
K = ±10%
M = ±20%

C

Case Size
See table above

□

Packaging
See Tape & Reel Packaging Section

TECHNICAL SPECIFICATIONS

Category Temperature Range	-55 to +125°C
Rated Temperature	+85°C
Capacitance Tolerance	±20%, ±10% at 120Hz
Dissipation Factor	Refer to next page
ESR 100kHz	Refer to next page
Leakage Current	After 1 minute's application of rated voltage, leakage current at 20°C is not more than 0.01CV or 0.5µA, whichever is greater. After 1 minute's application of rated voltage, leakage current at 85°C is not more than 0.1CV or 5µA, whichever is greater. After 1 minute's application of derated voltage, leakage current at 125°C is not more than 0.125CV or 6.3µA, whichever is greater.
Capacitance Change By Temperature	+15% Max. at +125°C +10% Max. at +85°C -10% Max. at -55°C

F91 Series

Low ESR, Resin-Molded Chip J-Lead



CAPACITANCE AND RATED VOLTAGE RANGE (LETTER DENOTES CASE SIZE)

Capacitance		Rated Voltage						
μF	Code	4V (0G)	6.3V (0J)	10V (1A)	16V (1C)	20V (1D)	25V (1E)	35V (1V)
6.8	685							C
10	106						C	N
15	156					C		N
22	226				B		N	N
33	336				B/C		N	
47	476			B	N	N	N	
68	686			C				
100	107		C	C	N			
150	157	C	C	N				
220	227	C	C/N	N				
330	337	N	N	N				
470	477	N	N					
680	687	N						

Released ratings

RATINGS & PART NUMBER REFERENCE

AVX Part No.	Case Size	Capacitance (μF)	Rated Voltage (V)	DCL (μA)	DF @ 120Hz (%)	ESR @ 100kHz (mΩ)	100kHz RMS Current (mA)			MSL
							25°C	85°C	125°C	
4 Volt										
F910G157#CC	C	150	4	6.0	12	250	663	597	265	1
F910G227#CC	C	220	4	8.8	12	250	663	597	265	1
F910G337#NC	N	330	4	13.2	10	100	1225	1102	490	1
F910G477#NC	N	470	4	18.8	16	100	1225	1102	490	1
F910G687#NC	N	680	4	27.2	18	100	1225	1102	490	1
6.3 Volt										
F910J107#CC	C	100	6.3	6.3	8	250	663	597	265	1
F910J157#CC	C	150	6.3	9.5	12	250	663	597	265	1
F910J227#CC	C	220	6.3	13.9	14	250	663	597	265	1
F910J227#NC	N	220	6.3	13.9	10	100	1225	1102	490	1
F910J337#NC	N	330	6.3	20.8	14	100	1225	1102	490	1
F910J477#NC	N	470	6.3	29.6	16	100	1225	1102	490	1
10 Volt										
F911A476#BA	B	47	10	4.7	8	500	412	371	165	1
F911A686#CC	C	68	10	6.8	8	300	606	545	242	1
F911A107#CC	C	100	10	10.0	10	250	663	597	265	1
F911A157#NC	N	150	10	15.0	10	100	1225	1102	490	1
F911A227#NC	N	220	10	22.0	12	100	1225	1102	490	3
F911A337#NC	N	330	10	33.0	18	100	1225	1102	490	3
16 Volt										
F911C226#BA	B	22	16	3.5	8	950	299	269	120	1
F911C336#BA	B	33	16	5.3	8	950	299	269	120	1
F911C336#CC	C	33	16	5.3	6	400	524	472	210	1
F911C476#NC	N	47	16	7.6	6	150	1000	900	400	1
F911C107#NC	N	100	16	16	10	100	1225	1102	490	3
20 Volt										
F911D156#CC	C	15	20	3	6	450	494	445	198	1
F911D476#NC	N	47	20	9.4	8	200	866	779	346	1
25 Volt										
F911E106#CC	C	10	25	2.5	6	450	494	445	198	1
F911E226#NC	N	22	25	5.5	6	200	866	779	346	1
F911E336#NC	N	33	25	8.3	8	200	866	779	346	1
F911E476#NC	N	47	25	11.8	8	250	775	697	310	1
35 Volt										
F911V685#CC	C	6.8	35	2.4	6	600	428	385	171	1
F911V106#NC	N	10	35	3.5	6	300	707	636	283	1
F911V156#NC	N	15	35	5.3	6	300	707	636	283	1
F911V226#NC	N	22	35	7.7	8	300	707	636	283	1

#: "M" for ±20% tolerance, "K" for ± 10% tolerance.

Moisture Sensitivity Level (MSL) is defined according to J-STD-020.

F91 Series

Low ESR, Resin-Molded Chip J-Lead

QUALIFICATION TABLE

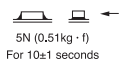
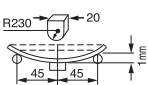
TEST	F91 series (Temperature range -55°C to +125°C)	
	Condition	
Damp Heat (Steady State)	At 40°C, 90 to 95% R.H., 500 hours (No voltage applied) Capacitance Change Within ±10% of the initial value Dissipation Factor Initial specified value or less Leakage Current Initial specified value or less	
Temperature Cycles	-55°C / +125°C, 30 minutes each, 5 cycles Capacitance Change Within ±5% of the initial value Dissipation Factor Initial specified value or less Leakage Current Initial specified value or less	
Resistance to Soldering Heat	10 seconds reflow at 260°C, 5 seconds immersion at 260°C. Capacitance Change Within ±5% of the initial value Dissipation Factor Initial specified value or less Leakage Current Initial specified value or less	
Surge	After application of surge voltage in series with a 33Ω resistor at the rate of 30 seconds ON, 30 seconds OFF, for 1000 successive test cycles at 85°C, capacitors shall meet the characteristic requirements in the table above. Capacitance Change Within ±5% of the initial value Dissipation Factor Initial specified value or less Leakage Current Initial specified value or less	
Endurance	After 2000 hours' application of rated voltage in series with a 3Ω resistor at 85°C, or derated voltage in series with a 3Ω resistor at 125°C, capacitors shall meet the characteristic requirements in the table above. Capacitance Change Within ±10% of the initial value Dissipation Factor Initial specified value or less Leakage Current Initial specified value or less	
Shear Test	After applying the pressure load of 5N for 10±1 seconds horizontally to the center of capacitor side body which has no electrode and has been soldered beforehand on a substrate, there shall be found neither exfoliation nor its sign at the terminal electrode.	 5N (0.51kg - f) For 10±1 seconds
Terminal Strength	Keeping a capacitor surface-mounted on a substrate upside down and supporting the substrate at both of the opposite bottom points 45mm apart from the center of capacitor, the pressure strength is applied with a specified jig at the center of substrate so that the substrate may bend by 1mm as illustrated. Then, there shall be found no remarkable abnormality on the capacitor terminals.	 R230 20 45 45 1mm

F91 Series

Low ESR, Resin-Molded Chip J-Lead

AVX SOLID ELECTROLYTE CAPACITOR ROADMAP

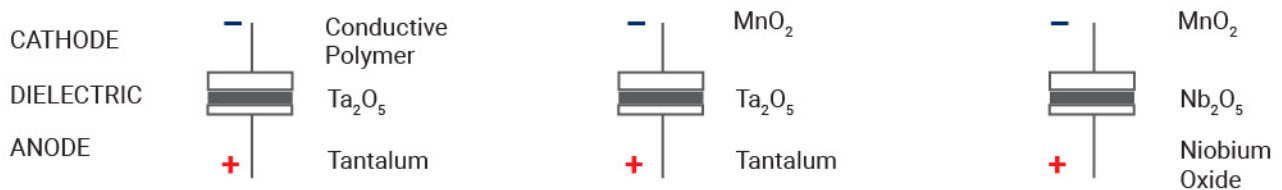
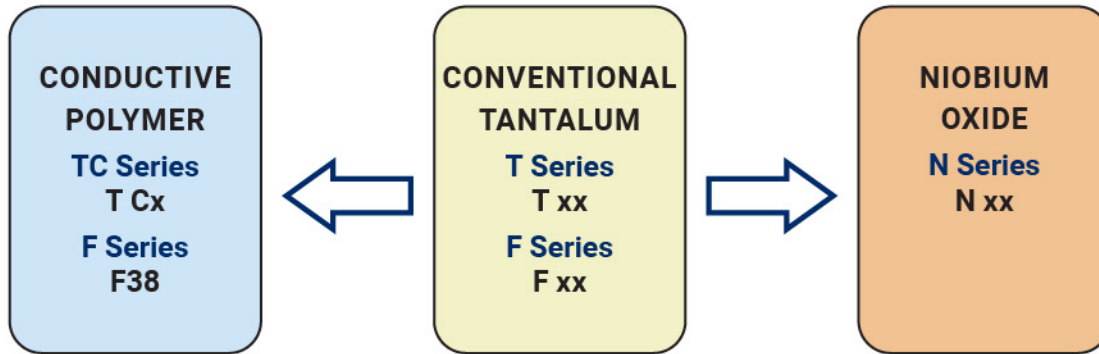

FIVE CAPACITOR CONSTRUCTION STYLES

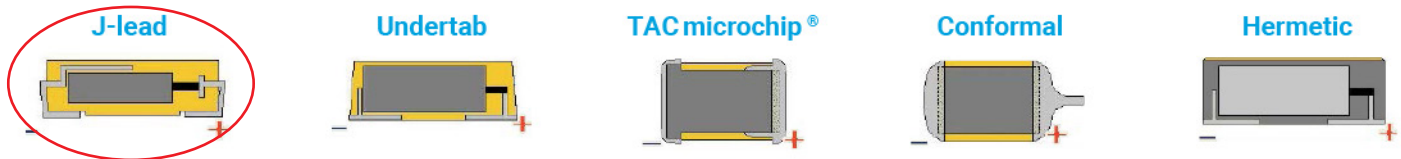

SERIES LINE UP : CONVENTIONAL SMD MnO₂

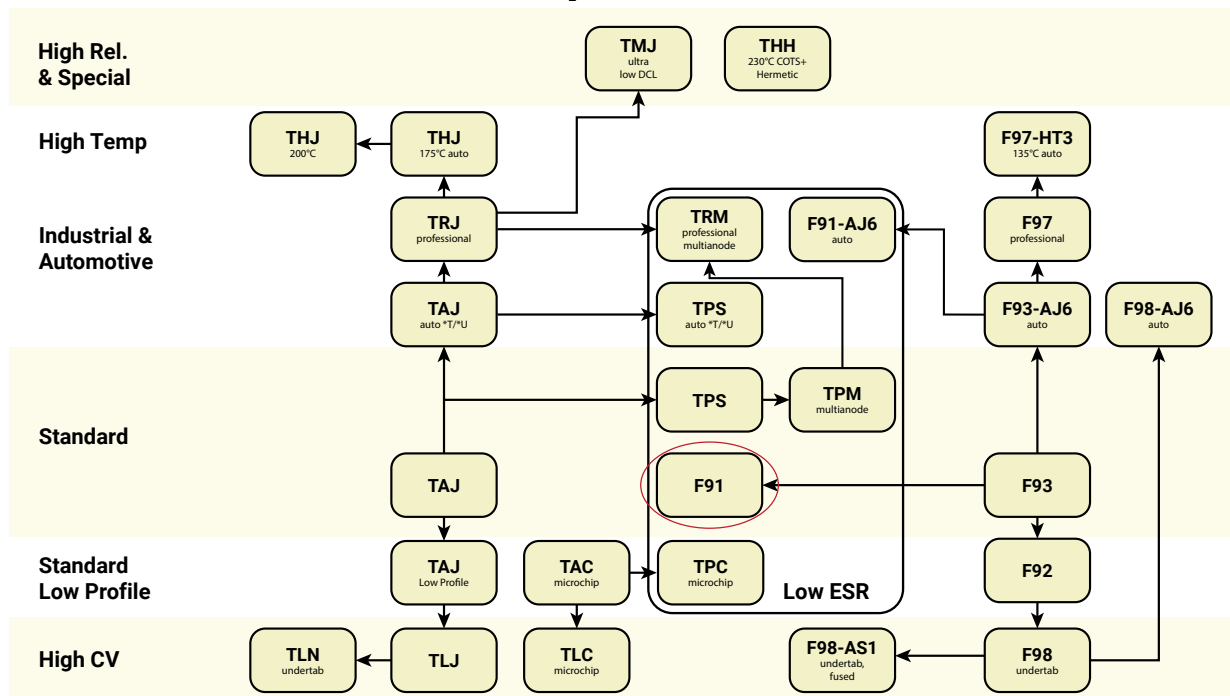

F91-AJ6 Series

Low ESR, Resin-Molded Chip - Automotive Product Range

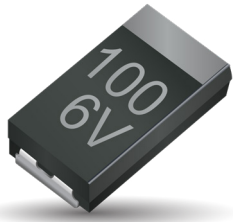

FEATURES

- Compliant to the RoHS3 directive 2015/863/EU
- Compliant to AEC-Q200
- 100% Surge Current Tested

APPLICATIONS

- Cabin Electronics
- Infotainment



CASE DIMENSIONS:

millimeters (inches)

Code	EIA Code	EIA Metric	L	W ₁	W ₂	H	S
A	1206	3216-18	3.20 ± 0.20 (0.126 ± 0.008)	1.60 ± 0.20 (0.063 ± 0.008)	1.20 ± 0.10 (0.047 ± 0.004)	1.60 ± 0.20 (0.063 ± 0.008)	0.80 ± 0.20 (0.031 ± 0.008)
B	1210	3528-21	3.50 ± 0.20 (0.138 ± 0.008)	2.80 ± 0.20 (0.110 ± 0.008)	2.20 ± 0.10 (0.087 ± 0.004)	1.90 ± 0.20 (0.075 ± 0.008)	0.80 ± 0.20 (0.031 ± 0.008)
N	2917	7343-30	7.30 ± 0.20 (0.287 ± 0.008)	4.30 ± 0.20 (0.169 ± 0.008)	2.40 ± 0.10 (0.094 ± 0.004)	2.80 ± 0.20 (0.110 ± 0.008)	1.30 ± 0.20 (0.051 ± 0.008)

A, B CASE

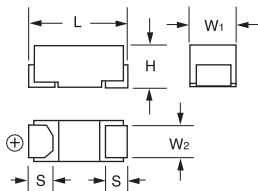

N CASE

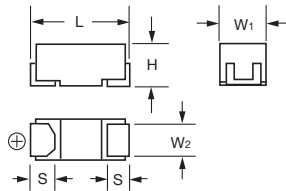

MARKING

A CASE

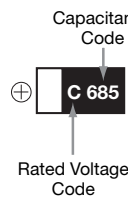

B CASE

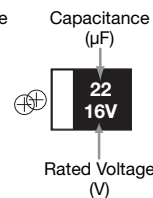

N CASE

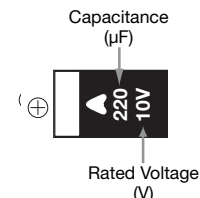

6.3V	J
10V	A
16V	C

HOW TO ORDER

F91

Type

1C

Rated Voltage

226

Capacitance Code
pF code: 1st two digits represent significant figures, 3rd digit represents multiplier (number of zeros to follow)

M

Tolerance
K = ±10%
M = ±20%

B

Case Size
See table above



Packaging
See Tape & Reel Packaging Section

AJ6

Tolerance
K = ±10%
M = ±20%

TECHNICAL SPECIFICATIONS

Category Temperature Range	-55 to +125°C
Rated Temperature	+85°C
Capacitance Tolerance	±20%, ±10% at 120Hz
Dissipation Factor	Refer to next page
ESR 100kHz	Refer to next page
Leakage Current	After 1 minute's application of rated voltage, leakage current at 20°C is not more than 0.01CV or 0.5µA, whichever is greater.
	After 1 minute's application of rated voltage, leakage current at 85°C is not more than 0.1CV or 5µA, whichever is greater.
	After 1 minute's application of derated voltage, leakage current at 125°C is not more than 0.125CV or 6.3µA, whichever is greater.
Capacitance Change By Temperature	+15% Max. at +125°C
	+10% Max. at +85°C
	-10% Max. at -55°C

F91-AJ6 Series

Low ESR, Resin-Molded Chip - Automotive Product Range



CAPACITANCE AND RATED VOLTAGE RANGE (LETTER DENOTES CASE SIZE)

Capacitance		Rated Voltage		
µF	Code	6.3V (0J)	10V (1A)	16V (1C)
10	106		A	A
22	226	A	A	B
33	336		B	B
47	476	A,B	B	
100	107	B		N
220	227		N	

Released ratings

1: ΔC/C Marked “”

Item	All Case (%)
Damp Heat	±10
Temperature cycles	±10
Resistance soldering heat	±10
Surge	±10
Endurance	±10

RATINGS & PART NUMBER REFERENCE

AVX Part No.	Case Size	Capacitance (µF)	Rated Voltage (V)	DCL (µA)	DF @ 120Hz (%)	ESR @ 100kHz (mΩ)	100kHz RMS Current (mA)			*1 ΔC/C (%)	MSL
							25°C	85°C	125°C		
6.3 Volt											
F910J226#AAAJ6	A	22	6.3	1.4	8	1250	245	220	98	*	3
F910J476#AAAJ6	A	47	6.3	3.0	18	1250	245	220	98	*	3
F910J476#BAAJ6	B	47	6.3	3.0	6	500	412	371	165	*	3
F910J107#BAAJ6	B	100	6.3	6.3	14	450	435	391	174	*	3
10 Volt											
F911A106#AAAJ6	A	10	10	1.0	6	1500	224	201	89	*	3
F911A226#AAAJ6	A	22	10	2.2	12	1250	245	220	98	*	3
F911A336#BAAJ6	B	33	10	3.3	8	700	348	314	139	*	3
F911A476#BAAJ6	B	47	10	4.7	8	500	412	371	165	*	3
F911A227#NCAJ6	N	220	10	22.0	12	100	1225	1102	490	*	3
16 Volt											
F911C106#AAAJ6	A	10	16	1.6	6	1500	224	201	89	*	3
F911C226#BAAJ6	B	22	16	3.5	8	950	299	269	120	*	3
F911C336#BAAJ6	B	33	16	5.3	8	950	299	269	120	*	3
F911C107#NCAJ6	N	100	16	16.0	10	100	1225	1102	490	*	3

#: "M" for ±20% tolerance, "K" for ± 10% tolerance. Moisture Sensitivity Level (MSL) is defined according to J-STD-020.

QUALIFICATION TABLE

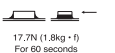
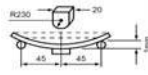
TEST	F91-AJ6 series (Temperature range -55°C to +125°C)	
	Condition	
Damp Heat (Steady State)	At 40°C, 90 to 95% R.H., 500 hours (No voltage applied) Capacitance Change Refer to above (*1) Dissipation Factor Initial specified value or less Leakage Current Initial specified value or less	
Load Humidity	After 1000 hour's application of rated voltage in series with a 33Ω resistor at 85°C, 85% R.H., capacitors meet the characteristics requirements table below. Capacitance Change Refer to above (*1) Dissipation Factor Initial specified value or less Leakage Current 125% or less than the initial specified value	
Temperature Cycles	At -55°C / +125°C, 30 minutes each, 1000 cycles Capacitance Change Refer to above (*1) Dissipation Factor Initial specified value or less Leakage Current Initial specified value or less	
Resistance to Soldering Heat	10 seconds reflow at 260°C, 10 seconds immersion at 260°C. Capacitance Change Refer to above (*1) Dissipation Factor Initial specified value or less Leakage Current Initial specified value or less	
Surge	After application of surge voltage in series with a 33Ω resistor at the rate of 30 seconds ON, 30 seconds OFF, for 1000 successive test cycles at 85°C, capacitors shall meet the characteristic requirements in the table above. Capacitance Change Refer to above (*1) Dissipation Factor Initial specified value or less Leakage Current Initial specified value or less	
Endurance	After 2000 hours' application of rated voltage in series with a 3Ω resistor at 85°C, or derated voltage in series with a 30 resistor at 125°C, capacitors shall meet the characteristic requirements in the table above. Capacitance Change Refer to above (*1) Dissipation Factor Initial specified value or less Leakage Current Initial specified value or less	
Shear Test	After applying the pressure load of 17.7N for 60 seconds horizontally to the center of capacitor side body which has no electrode and has been soldered beforehand on a substrate, there shall be found neither exfoliation nor its sign at the terminal electrode.	
Terminal Strength	Keeping a capacitor surface-mounted on a substrate upside down and supporting the substrate at both of the opposite bottom points 45mm apart from the center of capacitor, the pressure strength is applied with a specified jig at the center of the substrate so that substrate may bend by 1mm as illustrated. Then, there shall be found no remarkable abnormality on the capacitor terminals.	
Failure Rate	1% per 1000 hours at 85°C, V _R with 0.1Ω/V series impedance, 60% confidence level.	

F91-AJ6 Series

Low ESR, Resin-Molded Chip - Automotive Product Range

AVX SOLID ELECTROLYTIC CAPACITOR ROADMAP

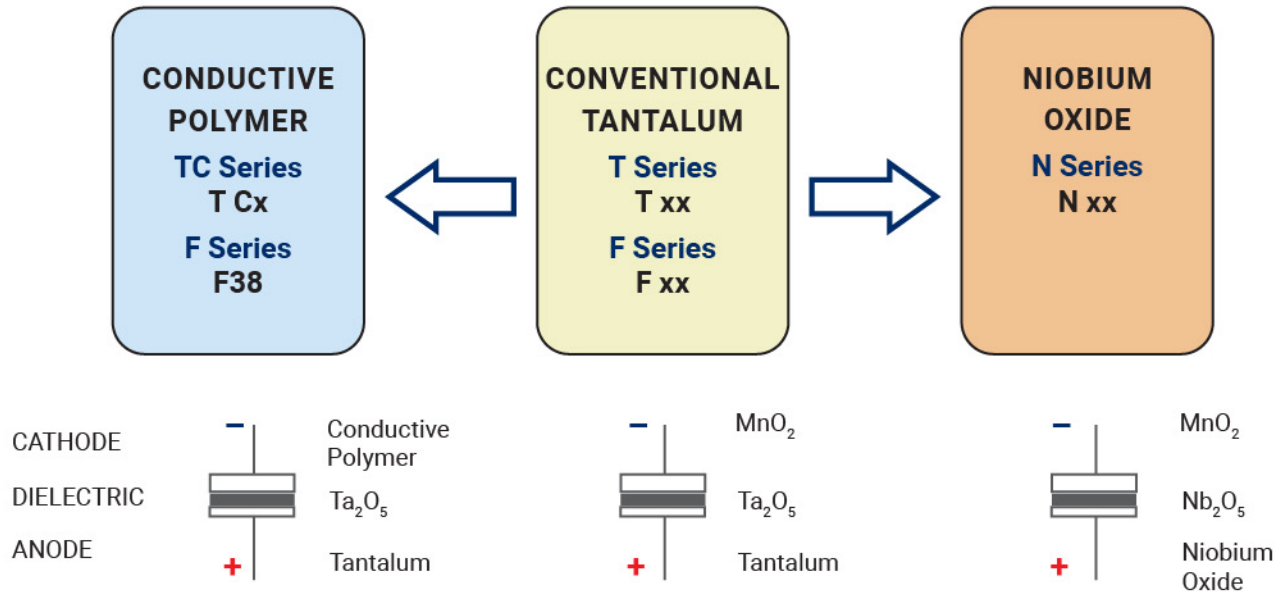

FIVE CAPACITOR CONSTRUCTION STYLES

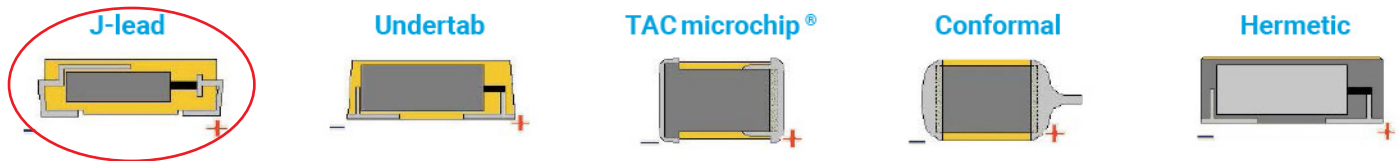

SERIES LINE UP : CONVENTIONAL SMD MnO₂

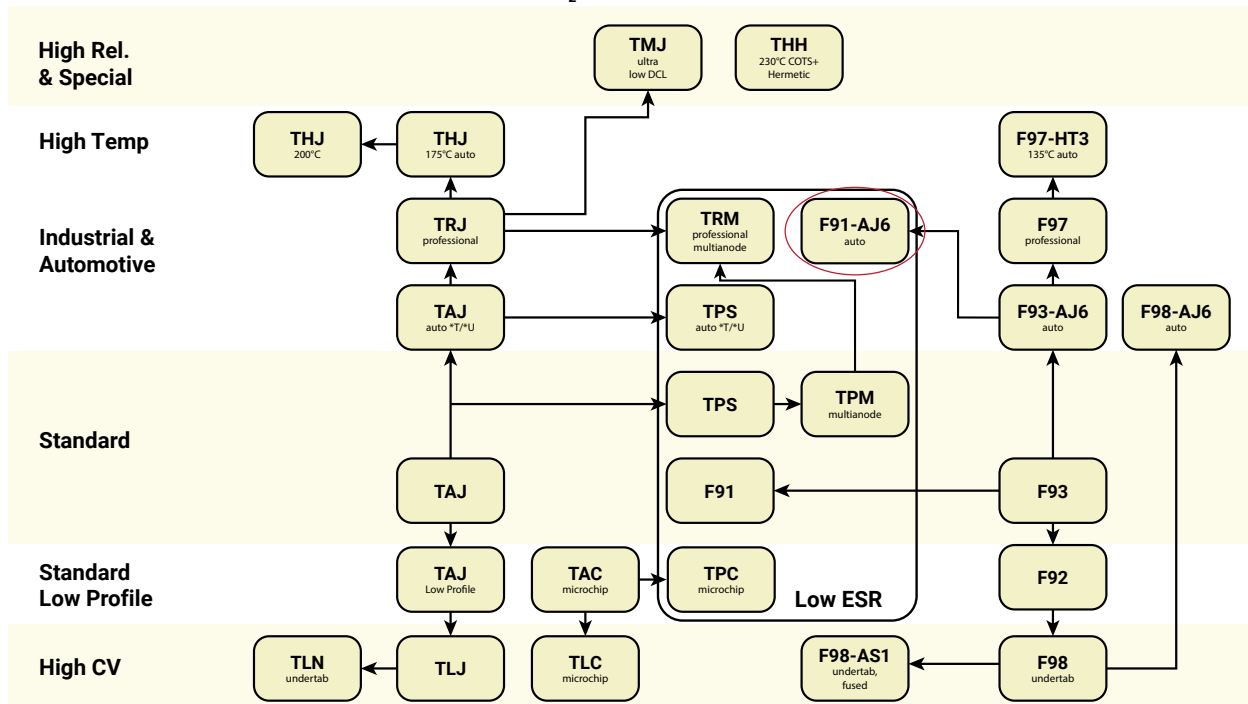

TPM Multianode

Tantalum Ultra Low ESR Capacitor

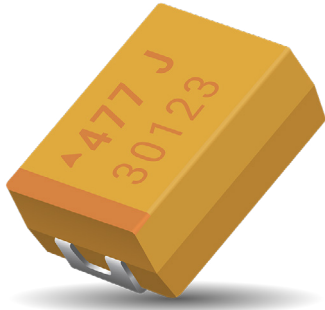

FEATURES

- Multi-anode Construction
- Super Low ESR
- 100% Surge Current Tested
- CV Range: 10-2200 μ F / 2.5-50V
- 5 Case Sizes Available
- "Mirror" Multi-anode Construction Used with D, Y Case Capacitors Reduces ESL to Half



SnPb termination option is not RoHS compliant.

APPLICATIONS

- High Power DC/DC General Applications

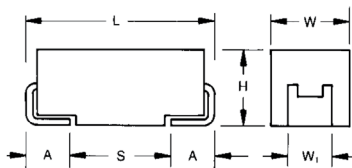

MULTIANODE CONSTRUCTION



MULTIANODE TPM D, Y LOW SELF INDUCTANCE CONSTRUCTION "MIRROR" DESIGN

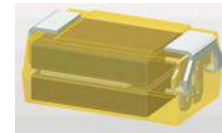

MARKING

D, E, U, V, Y CASE

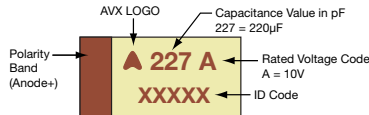

CASE DIMENSIONS:

millimeters (inches)

Code	EIA Code	EIA Metric	L \pm 0.20 (0.008)	W \pm 0.20 (0.008) -0.10 (0.004)	H \pm 0.20 (0.008) -0.10 (0.004)	W \pm 0.20 (0.008)	A \pm 0.30 (0.012) -0.20 (0.008)	S Min.
D	2917	7343-31	7.30 (0.287)	4.30 (0.169)	2.90 (0.114)	2.40 (0.094)	1.30 (0.051)	4.40 (0.173)
E	2917	7343-43	7.30 (0.287)	4.30 (0.169)	4.10 (0.162)	2.40 (0.094)	1.30 (0.051)	4.40 (0.173)
U	2924	7361-43	7.30 (0.287)	6.10 (0.240)	4.10 (0.162)	3.10 (0.122)	1.30 (0.051)	4.40 (0.173)
V	2924	7361-38	7.30 (0.287)	6.10 (0.240)	3.55 (0.140)	3.10 (0.122)	1.30 (0.051)	4.40 (0.173)
Y	2917	7343-20	7.30 (0.287)	4.30 (0.169)	2.00 (0.079) max	2.40 (0.094)	1.30 (0.051)	4.40 (0.173)

W1 dimension applies to the termination width for A dimensional area only.

HOW TO ORDER

TPM

Type

E

Case Size
See table above

108

Capacitance Code
pF code: 1st two digits represent significant figures, 3rd digit represents multiplier (number of zeros to follow)

M

Tolerance
K = \pm 10%
M = \pm 20%

004

Rated DC Voltage
002=2.5Vdc
004=4Vdc
006=6.3Vdc
010=10Vdc
016=16Vdc
020=20Vdc
025=25Vdc
035=35Vdc
050=50Vdc

R

Packaging
R = Pure Tin 7" Reel
S = Pure Tin 13" Reel
H = Tin Lead 7" Reel
(Contact Manufacturer)
K = Tin Lead 13" Reel
(Contact Manufacturer)
H, K = Non RoHS

0018

ESR in m Ω

TECHNICAL SPECIFICATIONS

Technical Data:		All technical data relate to an ambient temperature of +25°C									
Capacitance Range:		10 μ F to 2200 μ F									
Capacitance Tolerance:		\pm 10%, \pm 20%									
Rated Voltage (V_R)	\leq +85°C:	2.5	4	6.3	10	16	20	25	35	50	
Category Voltage (V_C)	\leq +125°C:	1.7	2.7	4	7	10	13	17	23	33	
Surge Voltage (V_S)	\leq +85°C:	3.3	5.2	8	13	20	26	32	46	65	
Surge Voltage (V_S)	\leq +125°C:	2.2	3.4	5	8	13	16	20	28	40	
Temperature Range:		-55°C to +125°C									
Reliability:		1% per 1000 hours at 85°C, V_R with 0.1 Ω /V series impedance, 60% confidence level									

TPM Multianode

Tantalum Ultra Low ESR Capacitor



CAPACITANCE AND RATED VOLTAGE RANGE (LETTER DENOTES CASE SIZE)

Capacitance		Rated Voltage DC (V _R) to 85°C								
µF	Code	2.5V (e)	4V (G)	6.3V (J)	10V (A)	16V (C)	20V (D)	25V (E)	35V (V)	50V (T)
6.8	685									
10	106									D(140)/E(120)
15	156									E(75,100)
22	226								D(70) E(60,100)	E(75,100)
33	336							D(65)	E(50,65)	
47	476					D(100)	D(45,55)	D(55)/E(65)	E(55,65)	
68	686					D(40,50)		E(45,55)		
100	107				Y(45) ^(M)	D(40,50)	E(35,45)	E(45,60)		
150	157				Y(45) ^(M)	E(30,40)	E(35)			
220	227			Y(30) ^(M)	D(35)	E(25,40) U(30,40)				
330	337		D(25,35)	D(25,35)	D(35)/E(23,35)	E(50)				
470	477		D(25,35)	D(30) E(18,23,30)	E(23,30) U(23,30)					
680	687		D(25)/E(18,23)	E(18,23) U(18,23)/V(23)						
1000	108	D(25)	D(25,45) E(18,23) U(18,23)/V(18)	E(25) ^(M) /V(20) ^(M)						
1500	158	E(12,15,18) U(18,23)	E(15,18)							
2200	228	E(18) ^(M)								

Released ratings ^(M tolerance only), (ESR ratings in mOhms in parentheses)

Note: Voltage ratings are minimum values. AVX reserves the right to supply higher voltage ratings in the same case size, to the same reliability standards.

TPM Multianode

Tantalum Ultra Low ESR Capacitor



RATINGS & PART NUMBER REFERENCE

AVX Part No.	Case Size	Capacitance (µF)	Rated Voltage (V)	Rated Temperature (°C)	Category Voltage (V)	Category Temperature (°C)	DCL Max. (µA)	DF Max. (%)	ESR Max. @ 100kHz (mΩ)	100kHz RMS Current (A)			MSL
										25°C	85°C	125°C	
2.5 Volt @ 85°C													
TPMD108*002#0025	D	1000	2.5	85	1.7	125	25	8	25	3.194	2.874	1.277	3
TPME158*002#0012	E	1500	2.5	85	1.7	125	38	6	12	4.743	4.269	1.897	3
TPME158*002#0015	E	1500	2.5	85	1.7	125	38	6	15	4.243	3.818	1.697	3
TPME158*002#0018	E	1500	2.5	85	1.7	125	38	6	18	3.873	3.486	1.549	3
TPMU158*002R0018	U	1500	2.5	85	1.7	125	30	6	18	4.048	3.643	1.619	3
TPMU158*002R0023	U	1500	2.5	85	1.7	125	30	6	23	3.581	3.223	1.433	3
TPME228M002#0018	E	2200	2.5	85	1.7	125	44	10	18	3.873	3.486	1.549	3
4 Volt @ 85°C													
TPMD337*004#0025	D	330	4	85	2.7	125	13.2	8	25	3.194	2.874	1.277	3
TPMD337*004#0035	D	330	4	85	2.7	125	13.2	8	35	2.699	2.429	1.080	3
TPMD477*004#0025	D	470	4	85	2.7	125	18.8	8	25	3.194	2.874	1.277	3
TPMD477*004#0035	D	470	4	85	2.7	125	18.8	8	35	2.699	2.429	1.080	3
TPMD687*004#0025	D	680	4	85	2.7	125	27.2	8	25	3.194	2.874	1.277	3
TPME687*004#0018	E	680	4	85	2.7	125	27	6	18	3.873	3.486	1.549	3
TPME687*004#0023	E	680	4	85	2.7	125	27	6	23	3.426	3.084	1.370	3
TPMD108*004#0025	D	1000	4	85	2.7	125	40	8	25	3.194	2.874	1.277	3
TPMD108*004#0045	D	1000	4	85	2.7	125	40	8	45	2.380	2.142	0.952	3
TPME108*004#0018	E	1000	4	85	2.7	125	40	6	18	3.873	3.486	1.549	3
TPME108*004#0023	E	1000	4	85	2.7	125	40	6	23	3.426	3.084	1.370	3
TPMU108*004R0018	U	1000	4	85	2.7	125	40	6	18	4.048	3.643	1.619	3
TPMU108*004R0023	U	1000	4	85	2.7	125	40	6	23	3.581	3.223	1.433	3
TPMV108*004#0018	V	1000	4	85	2.7	125	40	6	18	3.979	3.581	1.592	3
TPME158*004#0015	E	1500	4	85	2.7	125	60	6	15	4.243	3.818	1.697	3
TPME158*004#0018	E	1500	4	85	2.7	125	60	6	18	3.873	3.486	1.549	3
6.3 Volt @ 85°C													
TPMY227M006#0030	Y	220	6.3	85	4	125	13.2	6	30	2.646	2.381	1.058	3
TPMD337*006#0025	D	330	6.3	85	4	125	19.8	8	25	3.194	2.874	1.277	3
TPMD337*006#0035	D	330	6.3	85	4	125	19.8	8	35	2.699	2.429	1.080	3
TPMD477*006#0030	D	470	6.3	85	4	125	28.2	8	30	2.915	2.624	1.166	3
TPME477*006#0018	E	470	6.3	85	4	125	28	6	18	3.873	3.486	1.549	3
TPME477*006#0023	E	470	6.3	85	4	125	28	6	23	3.426	3.084	1.370	3
TPME477*006#0030	E	470	6.3	85	4	125	28	6	30	3.000	2.700	1.200	3
TPME687*006#0018	E	680	6.3	85	4	125	41	6	18	3.873	3.486	1.549	3
TPME687*006#0023	E	680	6.3	85	4	125	41	6	23	3.426	3.084	1.370	3
TPMU687*006R0018	U	680	6.3	85	4	125	41	6	18	4.048	3.643	1.619	3
TPMU687*006R0023	U	680	6.3	85	4	125	41	6	23	3.581	3.223	1.433	3
TPMV687*006#0023	V	680	6.3	85	4	125	41	6	23	3.520	3.168	1.408	3
TPME108M006#0025	E	1000	6.3	85	4	125	63	8	25	3.286	2.958	1.315	3
TPMV108M006#0020	V	1000	6.3	85	4	125	63	8	20	3.775	3.397	1.510	3
10 Volt @ 85°C													
TPMY107M010#0045	Y	100	10	85	7	125	10	8	45	2.160	1.944	0.864	3
TPMY157M010#0045	Y	150	10	85	7	125	15	8	45	2.160	1.944	0.864	3
TPMD227*010#0035	D	220	10	85	7	125	22	8	35	2.699	2.429	1.080	3
TPMD337*010#0035	D	330	10	85	7	125	33	8	35	2.699	2.429	1.080	3
TPME337*010#0023	E	330	10	85	7	125	33	6	23	3.426	3.084	1.370	3
TPME337*010#0035	E	330	10	85	7	125	33	6	35	2.777	2.500	1.111	3
TPME477*010#0023	E	470	10	85	7	125	47	6	23	3.426	3.084	1.370	3
TPME477*010#0030	E	470	10	85	7	125	47	6	30	3.000	2.700	1.200	3
TPMU477*010R0023	U	470	10	85	7	125	47	8	23	3.581	3.223	1.433	3
TPMU477*010R0030	U	470	10	85	7	125	47	8	30	3.136	2.822	1.254	3
16 Volt @ 85°C													
TPMD476*016#0100	D	47	16	85	10	125	7.5	8	100	1.597	1.437	0.639	3
TPMD686*016#0040	D	68	16	85	10	125	10.9	8	40	2.525	2.272	1.010	3
TPMD686*016#0050	D	68	16	85	10	125	10.9	8	50	2.258	2.032	0.903	3
TPMD107*016#0040	D	100	16	85	10	125	16	8	40	2.525	2.272	1.010	3
TPMD107*016#0050	D	100	16	85	10	125	16	8	50	2.258	2.032	0.903	3
TPME157*016#0030	E	150	16	85	10	125	24	6	30	3.000	2.700	1.200	3
TPME157*016#0040	E	150	16	85	10	125	24	6	40	2.598	2.338	1.039	3
TPME227*016#0025	E	220	16	85	10	125	35	6	25	3.286	2.958	1.315	3
TPME227*016#0040	E	220	16	85	10	125	35	6	40	2.598	2.338	1.039	3
TPMU227*016R0030	U	220	16	85	10	125	35	8	30	3.136	2.822	1.254	3
TPMU227*016R0040	U	220	16	85	10	125	35	8	40	2.716	2.444	1.086	3
TPME337*016#0050	E	330	16	85	10	125	52.8	10	50	2.324	2.091	0.930	3
20 Volt @ 85°C													
TPMD476*020#0045	D	47	20	85	13	125	9.4	8	45	2.380	2.142	0.952	3
TPMD476*020#0055	D	47	20	85	13	125	9.4	8	55	2.153	1.938	0.861	3
TPME107*020#0035	E	100	20	85	13	125	20	6	35	2.777	2.500	1.111	3
TPME107*020#0045	E	100	20	85	13	125	20	6	45	2.449	2.205	0.980	3
TPME157*020#0035	E	150	20	85	13	125	30	10	35	2.777	2.500	1.111	3

TPM Multianode

Tantalum Ultra Low ESR Capacitor



RATINGS & PART NUMBER REFERENCE

AVX Part No.	Case Size	Capacitance (µF)	Rated Voltage (V)	Rated Temperature (°C)	Category Voltage (V)	Category Temperature (°C)	DCL Max. (µA)	DF Max. (%)	ESR Max. @ 100kHz (mΩ)	100kHz RMS Current (A)			MSL
										25°C	85°C	125°C	
25 Volt @ 85°C													
TPMD336*025#0065	D	33	25	85	17	125	8.3	8	65	1.981	1.783	0.792	3
TPMD476*025#0055	D	47	25	85	17	125	11.8	8	55	2.153	1.938	0.861	3
TPME476*025#0065	E	47	25	85	17	125	11.8	6	65	2.038	1.834	0.815	3
TPME686*025#0045	E	68	25	85	17	125	17	6	45	2.449	2.205	0.980	3
TPME686*025#0055	E	68	25	85	17	125	17	6	55	2.216	1.994	0.886	3
TPME107*025#0045	E	100	25	85	17	125	25	14	45	2.449	2.205	0.980	3
TPME107*025#0060	E	100	25	85	17	125	25	14	60	2.121	1.909	0.849	3
35 Volt @ 85°C													
TPMD226*035#0070	D	22	35	85	23	125	7.7	8	70	1.909	1.718	0.763	3
TPME226*035#0060	E	22	35	85	23	125	8	6	60	2.121	1.909	0.849	3
TPME226*035#0100	E	22	35	85	23	125	8	6	100	1.643	1.479	0.657	3
TPME336*035#0050	E	33	35	85	23	125	12	6	50	2.324	2.091	0.930	3
TPME336*035#0065	E	33	35	85	23	125	12	6	65	2.038	1.834	0.815	3
TPME476*035#0055	E	47	35	85	23	125	16	6	55	2.216	1.994	0.886	3
TPME476*035#0065	E	47	35	85	23	125	16	6	65	2.038	1.834	0.815	3
50 Volt @ 85°C													
TPMD106*050#0140	D	10	50	85	33	125	5	8	140	1.350	1.215	0.540	3
TPME106*050#0120	E	10	50	85	33	125	5	6	120	1.500	1.350	0.600	3
TPME156*050#0075	E	15	50	85	33	125	7.5	6	75	1.897	1.708	0.759	3
TPME156*050#0100	E	15	50	85	33	125	7.5	6	100	1.643	1.479	0.657	3
TPME226*050#0075	E	22	50	85	33	125	11	8	75	1.897	1.708	0.759	3
TPME226*050#0100	E	22	50	85	33	125	11	8	100	1.643	1.479	0.657	3

Moisture Sensitivity Level (MSL) is defined according to J-STD-020

All technical data relates to an ambient temperature of +25°C. Capacitance and DF are measured at 120Hz, 0.5V RMS with a maximum DC bias of 2.2 volts.

DCL is measured at rated voltage after 5 minutes.

The EIA & CECC standards for low ESR Solid Tantalum Capacitors allow an ESR movement to 1.25 times catalogue limit post mounting.

For typical weight and composition see page 274.

NOTE: AVX reserves the right to supply higher voltage ratings or tighter tolerance part in the same case size, to the same reliability standards.

QUALIFICATION TABLE

TEST	TPM series (Temperature range -55°C to +125°C)									
	Condition			Characteristics						
Endurance	Apply rated voltage (Ur) at 85°C and / or category-voltage (Uc) at 125°C for 2000 hours through a circuit impedance of ≤0.1Ω/V. Stabilize at room temperature for 1-2 hours before measuring.			Visual examination	no visible damage					
				DCL	initial limit					
				ΔC/C	within ±10% of initial value					
				DF	initial limit					
				ESR	1.25 x initial limit					
Humidity	Store at 65°C and 95% relative humidity for 500 hours, with no applied voltage. Stabilize at room temperature and humidity for 1-2 hours before measuring.			Visual examination	no visible damage					
				DCL	1.5 x initial limit					
				ΔC/C	within ±10% of initial value					
				DF	1.2 x initial limit					
				ESR	1.25 x initial limit					
Temperature Stability	Step	Temperature°C	Duration(min)		+20°C	-55°C	+20°C	+85°C	+125°C	+20°C
	1	+20	15							
	2	-55	15	DCL	IL*	n/a	IL*	10 x IL*	12.5 x IL*	IL*
	3	+20	15	ΔC/C	n/a	+0/-10%	±5%	+10/-0%	+12/-0%	±5%
	4	+85	15	DF	IL*	1.5 x IL*	IL*	1.5 x IL*	2 x IL*	IL*
	5	+125	15	ESR	1.25 x IL*	2.5 x IL*	1.25 x IL*	1.25 x IL*	1.25 x IL*	1.25 x IL*
	6	+20	15							
Surge Voltage	Apply 1.3x category voltage (Uc) at 125°C for 1000 cycles of duration 6 min (30 sec charge, 5 min 30 sec discharge) through a charge / discharge resistance of 1000Ω			Visual examination	no visible damage					
				DCL	initial limit					
				ΔC/C	within ±5% of initial value					
				DF	initial limit					
				ESR	1.25 x initial limit					
Mechanical Shock	MIL-STD-202, Method 213, Condition C			Visual examination	no visible damage					
				DCL	initial limit					
				ΔC/C	within ±5% of initial value					
				DF	initial limit					
				ESR	initial limit					
Vibration	MIL-STD-202, Method 204, Condition D			Visual examination	no visible damage					
				DCL	initial limit					
				ΔC/C	within ±5% of initial value					
				DF	initial limit					
				ESR	initial limit					

*Initial Limit



The Important Information/Disclaimer is incorporated in the catalog where these specifications came from or available online at www.avx.com/disclaimer/ by reference and should be reviewed in full before placing any order.

TPM Multianode

Tantalum Ultra Low ESR Capacitor

AVX SOLID ELECTROLYTIC CAPACITOR ROADMAP

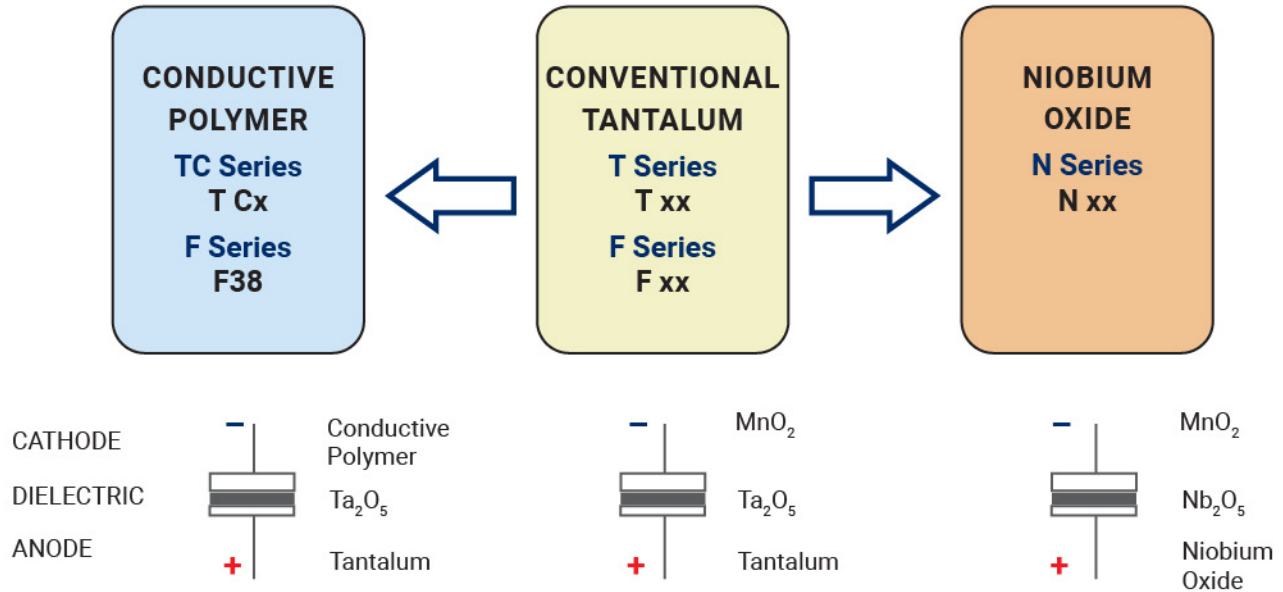

FIVE CAPACITOR CONSTRUCTION STYLES

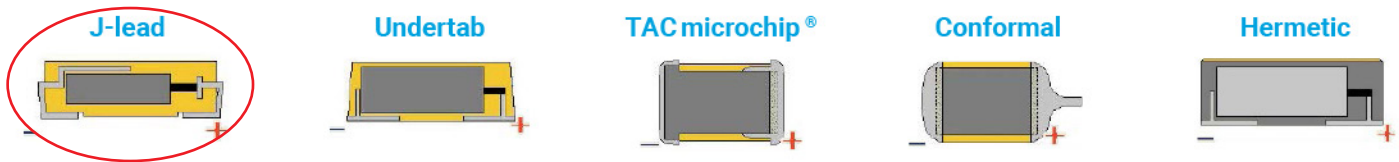

SERIES LINE UP : CONVENTIONAL SMD MnO₂

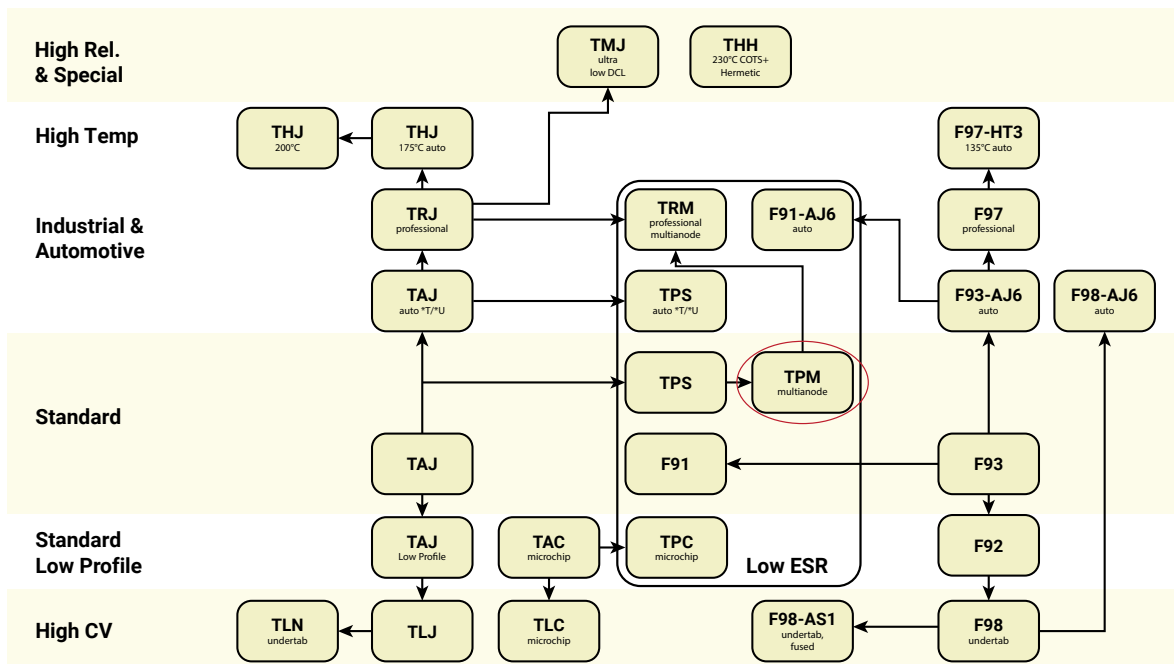

TRJ Series

Professional Tantalum Chip Capacitor

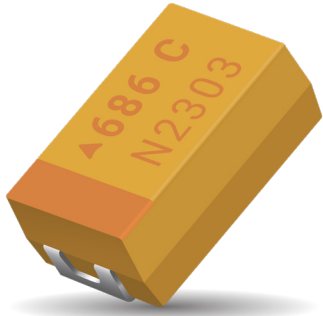

FEATURES

- Improved Reliability – 2x Standard
- DCL Reduced by 25% to 0.0075 CV
- Robust Against Higher Thermo-mechanical Stresses During Assembly Process
- 100% Surge Current Tested
- CV Range: 0.10-680µF / 4-50V
- 6 Case Sizes Available
- 130 Low ESR Parts Released
- Automotive, Industrial and Other Higher End Applications



SnPb termination option is not RoHS compliant.

APPLICATIONS

- Automotive ECU
- ABS
- Airbag Systems
- Avionics
- Industrial Control Units

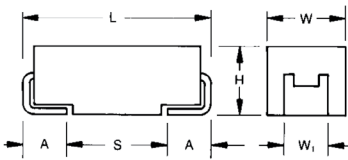

CASE DIMENSIONS:

millimeters (inches)

Code	EIA Code	EIA Metric	L±0.20 (0.008)	W+0.20 (0.008) -0.10 (0.004)	H+0.20 (0.008) -0.10 (0.004)	W1±0.20 (0.008)	A+0.30 (0.012) -0.20 (0.008)	S Min.
A	1206	3216-18	3.20 (0.126)	1.60 (0.063)	1.60 (0.063)	1.20 (0.047)	0.80 (0.031)	1.10 (0.043)
B	1210	3528-21	3.50 (0.138)	2.80 (0.110)	1.90 (0.075)	2.20 (0.087)	0.80 (0.031)	1.40 (0.055)
C	2312	6032-28	6.00 (0.236)	3.20 (0.126)	2.60 (0.102)	2.20 (0.087)	1.30 (0.051)	2.90 (0.114)
D	2917	7343-31	7.30 (0.287)	4.30 (0.169)	2.90 (0.114)	2.40 (0.094)	1.30 (0.051)	4.40 (0.173)
E	2917	7343-43	7.30 (0.287)	4.30 (0.169)	4.10 (0.162)	2.40 (0.094)	1.30 (0.051)	4.40 (0.173)
U	2924	7361-43	7.30 (0.287)	6.10 (0.240)	4.10 (0.162)	3.10 (0.122)	1.30 (0.051)	4.40 (0.173)

W₁ dimension applies to the termination width for A dimensional area only.

MARKING

A, B, C, D, E, U CASE

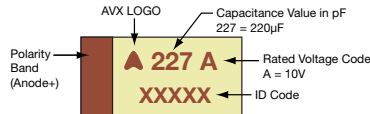

HOW TO ORDER

TRJ	B	105	*	035	R	RJ	-
Type	Case Size See table above	Capacitance Code pF code: 1st two digits represent significant figures, 3rd digit represents multiplier (number of zeros to follow)	Tolerance K = ±10% M = ±20%	Rated DC Voltage 004 = 4V 006 = 6.3V 010 = 10V 016 = 16V 020 = 20V 025 = 25V 035 = 35V 050 = 50V	Packaging R = Pure Tin 7" Reel S = Pure Tin 13" Reel A = Gold Plating 7" Reel (Contact Manufacturer) B = Gold Plating 13" Reel (Contact Manufacturer) H = Tin Lead 7" Reel (Contact Manufacturer) K = Tin Lead 13" Reel (Contact Manufacturer) H, K = Non RoHS	Standard Suffix OR 0100 Low ESR in mΩ	Additional characters may be added for special requirements V = Dry pack Option (selected codes only)

TECHNICAL SPECIFICATIONS

Technical Data:	All technical data relate to an ambient temperature of +25°C								
Capacitance Range:	0.10 µF to 680 µF								
Capacitance Tolerance:	±10%; ±20%								
Leakage Current DCL:	0.0075CV or 0.3µA whichever is the greater								
Rated Voltage (V _R)	≤ + 85°C:	4	6.3	10	16	20	25	35	50
Category Voltage (V _C)	≤ + 125°C:	2.7	4	7	10	13	17	23	33
Surge Voltage (V _S)	≤ + 85°C:	5.2	8	13	20	26	32	46	65
Surge Voltage (V _S)	≤ + 125°C:	3.4	5	8	13	16	20	28	40
Temperature Range:	-55°C to +125°C								
Reliability:	0.5% per 1000 hours at 85°C, V _R with 0.1Ω/V series impedance, 60% confidence level								
Termination Plating:	Sn Plating (standard), Gold and SnPb Plating upon request								
	Meets requirements of AEC-Q200								

TRJ Series

Professional Tantalum Chip Capacitor



CAPACITANCE AND RATED VOLTAGE RANGE (LETTER DENOTES CASE SIZE)

Capacitance		Rated Voltage DC (V _R) to 85°C							
µF	Code	4V (G)	6.3V (J)	10V (A)	16V (C)	20V (D)	25V (E)	35V (V)	50V (T)
0.10	104							A	
0.15	154							A, A(6000)	
0.22	224							A, A(6000)	A, A(7000)
0.33	334							A, A(6000)	A
0.47	474						A, A(7000)	A, A(4000)	B
0.68	684						A, A(6000)	A, A(6000)	B, B(2000)
1.0	105				A	A, A(3000)	A, A(3000)	A, B A(3000), B(2000)	C, B B(2000)
1.5	155			A		A, A(3000)	A, B, A(3000)	A, B A(2000), B(2500)	C, C(1500)
2.2	225			A	A, A(3500)	A, A(3000)	A, B A(1600), B(1200)	B, B(2000)	C, D C(1000), D(1200)
3.3	335				A, B A(3500)	A, B A(2500), B(1300)	B, B(2000)	B, C, D B(1000), C(800)	C, D C(1000), D(800)
4.7	475			A, A(2000)	A, B A(2000), B(1500)	A, B, A(1800), B(1000)	B, B(1000)	B, C, D B(1500), C(600)	D, D(600)
6.8	685			A, B, A(1800)	A, B, C A(1500), B(1200)	B, C B(1000)	B, C B(1000), C(600)	C, D C(600)	D
10	106		A, B A(1500)	A, B A(1800), B(800)	B, C B(800)	B, C B(1000), C(500)	C, D C(600)	C, D C(600), (250,400)	E, E(300,400)
15	156	B	A, B A(1500), B(700)	A, B, C A(1000), B(600)	B, B(800)	B, C, D B(500), C(400)	C, D C(500), D(300)	D, D(225)	U
22	226		A, B, C A(900), B(600)	B, B(700)	B, C, D B(600), C(350)	C, D, C(400), D(150,300)	D, D(300)	D, D(200,400)	U
33	336	C	B, C B(600)	B, C, D B(650), C(300)	C, C(300)	C, D C(300), D(250)	D, D(400)	E, E(150,250)	
47	476		B, C B(500), C(250)	C, D C(300)	C, D C(350), D(200)	D, D(200)	D, E D(250), E(150)	U, U(200)	
68	686		C, C(200)	C, C(300)	C, D C(200), D(150)	D, E D(200), E(120,200)	U		
100	107		C, C(300)	C, D, E C(200), D(100,150), E(100)	D, E D(150), E(150)	E, E(150)	U		
150	157		C, D C(300), D(150)	D, E D(150), E(150)	E, E(150)	U, U(250)			
220	227		D, D(150)	D, E, E(150)	U, U(200)				
330	337		D, E, E(150)	E, E(100)	U, U(200)				
470	477		E, E(200)	U, U(200)					
680	687		U, U(250)						

Note for designers – for the highlighted ratings, higher voltage options are now available in the same case size and are recommended for new designs.

Released ratings, (ESR ratings in mOhms in parentheses)

Note: Voltage ratings are minimum values. AVX reserves the right to supply

higher voltage ratings in the same case size, to the same reliability standards.



TRJ Series

Professional Tantalum Chip Capacitor



RATINGS & PART NUMBER REFERENCE

AVX Part No.	Case Size	Capacitance (µF)	Rated Voltage (V)	Rated Temperature (°C)	Category Voltage (V)	Category Temperature (°C)	DCL Max. (µA)	DF Max. (%)	ESR Max. @ 100kHz (mΩ)	100kHz RMS Current (mA)			MSL
										25°C	85°C	125°C	
4 Volt @ 85°C													
TRJB156*004#RJ	B	15	4	85	2.7	125	0.45	6	3000	168	151	67	1
TRJC336*004#RJ	C	33	4	85	2.7	125	1	6	2000	235	211	94	1
6.3 Volt @ 85°C													
TRJA106*006#RJ	A	10	6.3	85	4	125	0.45	6	2200	185	166	74	1
TRJA106*006#1500	A	10	6.3	85	4	125	0.45	6	1500	224	201	89	1
TRJB106*006#RJ	B	10	6.3	85	4	125	0.45	6	3000	168	151	67	1
TRJA156*006#RJ	A	15	6.3	85	4	125	0.68	6	2030	192	173	77	1
TRJA156*006#1500	A	15	6.3	85	4	125	0.68	6	1500	224	201	89	1
TRJB156*006#RJ	B	15	6.3	85	4	125	0.68	6	2030	205	184	82	1
TRJB156*006#0700	B	15	6.3	85	4	125	0.68	6	700	348	314	139	1
TRJA226*006#RJ	A	22	6.3	85	4	125	0.99	6	1700	210	189	84	1
TRJA226*006#0900	A	22	6.3	85	4	125	0.99	6	900	289	260	115	1
TRJB226*006#RJ	B	22	6.3	85	4	125	0.99	6	1880	213	191	85	1
TRJB226*006#0600	B	22	6.3	85	4	125	0.99	6	600	376	339	151	1
TRJC226*006#RJ	C	22	6.3	85	4	125	0.99	6	2000	235	211	94	1
TRJB336*006#RJ	B	33	6.3	85	4	125	1.5	6	1740	221	199	88	1
TRJB336*006#0600	B	33	6.3	85	4	125	1.5	6	600	376	339	151	1
TRJC336*006#RJ	C	33	6.3	85	4	125	1.5	6	1800	247	222	99	1
TRJB476*006#RJ	B	47	6.3	85	4	125	2.1	6	1620	229	206	92	1
TRJB476*006#0500	B	47	6.3	85	4	125	2.1	6	500	412	371	165	1
TRJC476*006#RJ	C	47	6.3	85	4	125	2.1	6	540	451	406	181	1
TRJC476*006#0250	C	47	6.3	85	4	125	2.1	6	250	663	597	265	1
TRJC686*006#RJ	C	68	6.3	85	4	125	3.1	6	490	474	426	190	1
TRJC686*006#0200	C	68	6.3	85	4	125	3.1	6	200	742	667	297	1
TRJC107*006#RJ	C	100	6.3	85	4	125	4.5	6	440	500	450	200	1
TRJC107*006#0300	C	100	6.3	85	4	125	4.5	6	300	606	545	242	1
TRJC157*006#RJ	C	150	6.3	85	4	125	6.8	8	500	469	422	188	1
TRJC157*006#0300	C	150	6.3	85	4	125	6.8	8	300	606	545	242	1
TRJD157*006#RJ	D	150	6.3	85	4	125	6.8	6	400	612	551	245	1
TRJD157*006#0150	D	150	6.3	85	4	125	6.8	6	150	1000	900	400	1
TRJD227*006#RJ	D	220	6.3	85	4	125	9.9	8	360	645	581	258	1
TRJD227*006#0150	D	220	6.3	85	4	125	9.9	8	150	1000	900	400	1
TRJD337*006#RJ	D	330	6.3	85	4	125	14	8	400	612	551	245	1
TRJE337*006#RJ	E	330	6.3	85	4	125	14	8	330	707	636	283	1 ¹⁾
TRJE337*006#0150	E	330	6.3	85	4	125	14	8	150	1049	944	420	1 ¹⁾
TRJE477*006#RJ	E	470	6.3	85	4	125	21	8	250	812	731	325	1 ¹⁾
TRJE477*006#0200	E	470	6.3	85	4	125	21	8	200	908	817	363	1 ¹⁾
TRJU687*006R0250V	U	680	6.3	85	4	125	30	30	500	574	517	230	3
TRJU687*006R0250V	U	680	6.3	85	4	125	30	30	250	812	731	325	3
10 Volt @ 85°C													
TRJA155*010#RJ	A	1.5	10	85	7	125	0.3	6	7000	104	93	41	1
TRJA225*010#RJ	A	2.2	10	85	7	125	0.3	6	7000	104	93	41	1
TRJA475*010#RJ	A	4.7	10	85	7	125	0.35	6	2900	161	145	64	1
TRJA475*010#2000	A	4.7	10	85	7	125	0.35	6	2000	194	174	77	1
TRJA685*010#RJ	A	6.8	10	85	7	125	0.51	6	2650	168	151	67	1
TRJA685*010#1800	A	6.8	10	85	7	125	0.51	6	1800	204	184	82	1
TRJB685*010#RJ	B	6.8	10	85	7	125	0.51	6	3000	168	151	67	1
TRJA106*010#RJ	A	10	10	85	7	125	0.75	6	2200	185	166	74	1
TRJA106*010#1800	A	10	10	85	7	125	0.75	6	1800	204	184	82	1
TRJB106*010#RJ	B	10	10	85	7	125	0.75	6	2200	197	177	79	1
TRJB106*010#0800	B	10	10	85	7	125	0.75	6	800	326	293	130	1
TRJA156*010#RJ	A	15	10	85	7	125	1.1	6	1800	204	184	82	1
TRJA156*010#1000	A	15	10	85	7	125	1.1	6	1000	274	246	110	1
TRJB156*010#RJ	B	15	10	85	7	125	1.1	6	2030	205	184	82	1
TRJB156*010#0600	B	15	10	85	7	125	1.1	6	600	376	339	151	1
TRJC156*010#RJ	C	15	10	85	7	125	1.1	6	2000	235	211	94	1
TRJB226*010#RJ	B	22	10	85	7	125	1.7	6	1880	213	191	85	1
TRJB226*010#0700	B	22	10	85	7	125	1.7	6	700	348	314	139	1
TRJB336*010#RJ	B	33	10	85	7	125	2.5	6	1000	292	262	117	1
TRJB336*010#0650	B	33	10	85	7	125	2.5	6	650	362	325	145	1
TRJC336*010#RJ	C	33	10	85	7	125	2.5	6	590	432	389	173	1
TRJC336*010#0300	C	33	10	85	7	125	2.5	6	300	606	545	242	1
TRJD336*010#RJ	D	33	10	85	7	125	2.5	6	1100	369	332	148	1
TRJC476*010#RJ	C	47	10	85	7	125	3.5	6	540	451	406	181	1
TRJC476*010#0300	C	47	10	85	7	125	3.5	6	300	606	545	242	1
TRJD476*010#RJ	D	47	10	85	7	125	3.5	6	400	612	551	245	1
TRJC686*010#RJ	C	68	10	85	7	125	5.1	6	490	474	426	190	1
TRJC686*010#0300	C	68	10	85	7	125	5.1	6	300	606	545	242	1
TRJC107*010#RJ	C	100	10	85	7	125	7.5	8	500	469	422	188	1
TRJC107*010#0200	C	100	10	85	7	125	7.5	8	200	742	667	297	1



The Important Information/Disclaimer is incorporated in the catalog where these specifications came from or available online at www.avx.com/disclaimer/ by reference and should be reviewed in full before placing any order.

TRJ Series

Professional Tantalum Chip Capacitor



RATINGS & PART NUMBER REFERENCE

AVX Part No.	Case Size	Capacitance (µF)	Rated Voltage (V)	Rated Temperature (°C)	Category Voltage (V)	Category Temperature (°C)	DCL Max. (µA)	DF Max. (%)	ESR Max. @ 100kHz (mΩ)	100kHz RMS Current (mA)			MSL
										25°C	85°C	125°C	
TRJD107*010#RJ	D	100	10	85	7	125	7.5	6	440	584	525	234	1
TRJD107*010#0100	D	100	10	85	7	125	7.5	6	100	1225	1102	490	1
TRJD107*010#0150	D	100	10	85	7	125	7.5	6	150	1000	900	400	1
TRJE107*010#RJ	E	100	10	85	7	125	7.5	6	440	612	551	245	1 ¹⁾
TRJE107*010#0100	E	100	10	85	7	125	7.5	6	100	1285	1156	514	1 ¹⁾
TRJD157*010#RJ	D	150	10	85	7	125	11	8	400	612	551	245	1
TRJD157*010#0150	D	150	10	85	7	125	11	8	150	1000	900	400	1
TRJE157*010#RJ	E	150	10	85	7	125	11	8	400	642	578	257	1 ¹⁾
TRJE157*010#0150	E	150	10	85	7	125	11	8	150	1049	944	420	1 ¹⁾
TRJD227*010#RJ	D	220	10	85	7	125	17	8	500	548	493	219	1
TRJE227*010#RJ	E	220	10	85	7	125	17	8	360	677	609	271	1 ¹⁾
TRJE227*010#0150	E	220	10	85	7	125	17	8	150	1049	944	420	1 ¹⁾
TRJE337*010#RJ	E	330	10	85	7	125	25	8	300	742	667	297	1 ¹⁾
TRJE337*010#0100	E	330	10	85	7	125	25	8	100	1285	1156	514	1 ¹⁾
TRJU477*010RRJV	U	470	10	85	7	125	35	30	400	642	578	257	3
TRJU477*010R0200V	U	470	10	85	7	125	35	30	200	908	817	363	3
16 Volt @ 85°C													
TRJA105*016#RJ	A	1.0	16	85	10	125	0.3	6	10000	87	78	35	1
TRJA225*016#RJ	A	2.2	16	85	10	125	0.3	6	4550	128	116	51	1
TRJA225*016#3500	A	2.2	16	85	10	125	0.3	6	3500	146	132	59	1
TRJA335*016#RJ	A	3.3	16	85	10	125	0.4	6	3740	142	127	57	1
TRJA335*016#3500	A	3.3	16	85	10	125	0.4	6	3500	146	132	59	1
TRJB335*016#RJ	B	3.3	16	85	10	125	0.4	6	4500	137	124	55	1
TRJA475*016#RJ	A	4.7	16	85	10	125	0.56	6	3160	154	139	62	1
TRJA475*016#2000	A	4.7	16	85	10	125	0.56	6	2000	194	174	77	1
TRJB475*016#RJ	B	4.7	16	85	10	125	0.56	6	3160	164	148	66	1
TRJB475*016#1500	B	4.7	16	85	10	125	0.56	6	1500	238	214	95	1
TRJA685*016#RJ	A	6.8	16	85	10	125	0.82	4	2000	194	174	77	1
TRJA685*016#1500	A	6.8	16	85	10	125	0.82	4	1500	224	201	89	1
TRJB685*016#RJ	B	6.8	16	85	10	125	0.82	6	2650	179	161	72	1
TRJB685*016#1200	B	6.8	16	85	10	125	0.82	6	1200	266	240	106	1
TRJC685*016#RJ	C	6.8	16	85	10	125	0.82	6	2500	210	189	84	1
TRJB106*016#RJ	B	10	16	85	10	125	1.2	6	2200	197	177	79	1
TRJB106*016#0800	B	10	16	85	10	125	1.2	6	800	326	293	130	1
TRJC106*016#RJ	C	10	16	85	10	125	1.2	6	2000	235	211	94	1
TRJB156*016#RJ	B	15	16	85	10	125	1.8	6	2030	205	184	82	1
TRJB156*016#0800	B	15	16	85	10	125	1.8	6	800	326	293	130	1
TRJB226*016#RJ	B	22	16	85	10	125	2.6	6	1100	278	250	111	1
TRJB226*016#0600	B	22	16	85	10	125	2.6	6	600	376	339	151	1
TRJC226*016#RJ	C	22	16	85	10	125	2.6	6	700	396	357	159	1
TRJC226*016#0350	C	22	16	85	10	125	2.6	6	350	561	505	224	1
TRJD226*016#RJ	D	22	16	85	10	125	2.6	6	1100	369	332	148	1
TRJC336*016#RJ	C	33	16	85	10	125	4	6	590	432	389	173	1
TRJC336*016#0300	C	33	16	85	10	125	4	6	300	606	545	242	1
TRJC476*016#RJ	C	47	16	85	10	125	5.6	6	540	451	406	181	1
TRJC476*016#0350	C	47	16	85	10	125	5.6	6	350	561	505	224	1
TRJD476*016#RJ	D	47	16	85	10	125	5.6	6	540	527	474	211	1
TRJD476*016#0200	D	47	16	85	10	125	5.6	6	200	866	779	346	1
TRJC686*016#RJ	C	68	16	85	10	125	8.2	6	490	474	426	190	1
TRJC686*016#0200	C	68	16	85	10	125	8.2	6	200	742	667	297	1
TRJD686*016#RJ	D	68	16	85	10	125	8.2	6	490	553	498	221	1
TRJD686*016#0150	D	68	16	85	10	125	8.2	6	150	1000	900	400	1
TRJD107*016#RJ	D	100	16	85	10	125	12	6	440	584	525	234	1
TRJD107*016#0150	D	100	16	85	10	125	12	6	150	1000	900	400	1
TRJE107*016#RJ	E	100	16	85	10	125	12	6	440	612	551	245	1 ¹⁾
TRJE107*016#0150	E	100	16	85	10	125	12	6	150	1049	944	420	1 ¹⁾
TRJE157*016#RJ	E	150	16	85	10	125	16	6	300	742	667	297	1 ¹⁾
TRJE157*016#0150	E	150	16	85	10	125	16	6	150	1049	944	420	1 ¹⁾
TRJU227*016RRJV	U	220	16	85	10	125	26.4	12	500	574	517	230	3
TRJU227*016R0200V	U	220	16	85	10	125	26.4	12	200	908	817	363	3
TRJU337*016RRJV	U	330	16	85	10	125	39	30	400	642	578	257	3
TRJU337*016R0200V	U	330	16	85	10	125	39	30	200	908	817	363	3
20 Volt @ 85°C													
TRJA105*020#RJ	A	1	20	85	13	125	0.3	4	6630	106	96	43	1
TRJA105*020#3000	A	1	20	85	13	125	0.3	4	3000	158	142	63	1
TRJA155*020#RJ	A	1.5	20	85	13	125	0.3	6	5460	117	105	47	1
TRJA155*020#3000	A	1.5	20	85	13	125	0.3	6	3000	158	142	63	1
TRJA225*020#RJ	A	2.2	20	85	13	125	0.33	6	4550	128	116	51	1
TRJA225*020#3000	A	2.2	20	85	13	125	0.33	6	3000	158	142	63	1
TRJA335*020#RJ	A	3.3	20	85	13	125	0.5	6	3740	142	127	57	1
TRJA335*020#2500	A	3.3	20	85	13	125	0.5	6	2500	173	156	69	1

TRJ Series

Professional Tantalum Chip Capacitor



RATINGS & PART NUMBER REFERENCE

AVX Part No.	Case Size	Capacitance (µF)	Rated Voltage (V)	Rated Temperature (°C)	Category Voltage (V)	Category Temperature (°C)	DCL Max. (µA)	DF Max. (%)	ESR Max. @ 100kHz (mΩ)	100kHz RMS Current (mA)			MSL
										25°C	85°C	125°C	
TRJB335*020#RJ	B	3.3	20	85	13	125	0.5	6	3740	151	136	60	1
TRJB335*020#1300	B	3.3	20	85	13	125	0.5	6	1300	256	230	102	1
TRJA475*020#RJ	A	4.7	20	85	13	125	0.71	5	2500	184	166	74	1
TRJA475*020#1800	A	4.7	20	85	13	125	0.71	5	1800	217	196	87	1
TRJB475*020#RJ	B	4.7	20	85	13	125	0.71	6	3160	164	148	66	1
TRJB475*020#1000	B	4.7	20	85	13	125	0.71	6	1000	292	262	117	1
TRJB685*020#RJ	B	6.8	20	85	13	125	1	6	2650	179	161	72	1
TRJB685*020#1000	B	6.8	20	85	13	125	1	6	1000	292	262	117	1
TRJC685*020#RJ	C	6.8	20	85	13	125	1	6	2000	235	211	94	1
TRJB106*020#RJ	B	10	20	85	13	125	1.5	6	2200	197	177	79	1
TRJB106*020#1000	B	10	20	85	13	125	1.5	6	1000	292	262	117	1
TRJC106*020#RJ	C	10	20	85	13	125	1.5	6	800	371	334	148	1
TRJC106*020#0500	C	10	20	85	13	125	1.5	6	500	469	422	188	1
TRJB156*020#RJ	B	15	20	85	13	125	2.3	6	1400	280	252	112	1
TRJB156*020#0500	B	15	20	85	13	125	2.3	6	500	469	422	188	1
TRJC156*020#RJ	C	15	20	85	13	125	2.3	6	720	391	352	156	1
TRJC156*020#0400	C	15	20	85	13	125	2.3	6	400	524	472	210	1
TRJD156*020#RJ	D	15	20	85	13	125	2.3	6	1100	369	332	148	1
TRJC226*020#RJ	C	22	20	85	13	125	3.3	6	650	411	370	165	1
TRJC226*020#0400	C	22	20	85	13	125	3.3	6	400	524	472	210	1
TRJD226*020#RJ	D	22	20	85	13	125	3.3	6	650	480	432	192	1
TRJD226*020#0150	D	22	20	85	13	125	3.3	6	150	1000	900	400	1
TRJD226*020#0300	D	22	20	85	13	125	3.3	6	300	707	636	283	1
TRJC336*020#RJ	C	33	20	85	13	125	5	6	590	432	389	173	1
TRJC336*020#0300	C	33	20	85	13	125	5	6	300	606	545	242	1
TRJD336*020#RJ	D	33	20	85	13	125	5	6	590	504	454	202	1
TRJD336*020#0250	D	33	20	85	13	125	5	6	250	775	697	310	1
TRJD476*020#RJ	D	47	20	85	13	125	7.1	6	540	527	474	211	1
TRJD476*020#0200	D	47	20	85	13	125	7.1	6	200	866	779	346	1
TRJD686*020#RJ	D	68	20	85	13	125	10	6	490	553	498	221	1
TRJD686*020#0200	D	68	20	85	13	125	10	6	200	866	779	346	1
TRJE686*020#RJ	E	68	20	85	13	125	10	6	490	580	522	232	1 ¹⁾
TRJE686*020#0120	E	68	20	85	13	125	10	6	120	1173	1055	469	1 ¹⁾
TRJE686*020#0200	E	68	20	85	13	125	10	6	200	908	817	363	1 ¹⁾
TRJE107*020#RJ	E	100	20	85	13	125	15	6	300	742	667	297	1 ¹⁾
TRJE107*020#0150	E	100	20	85	13	125	15	6	150	1049	944	420	1 ¹⁾
TRJU157*020RRJV	U	150	20	85	13	125	22	30	500	574	517	230	3
TRJU157*020R0250V	U	150	20	85	13	125	22	30	250	812	731	325	3
25 Volt @ 85°C													
TRJA474*025#RJ	A	0.47	25	85	17	125	0.3	4	9530	89	80	35	1
TRJA474*025#7000	A	0.47	25	85	17	125	0.3	4	7000	104	93	41	1
TRJA684*025#RJ	A	0.68	25	85	17	125	0.3	4	7980	97	87	39	1
TRJA684*025#6000	A	0.68	25	85	17	125	0.3	4	6000	112	101	45	1
TRJA105*025#RJ	A	1	25	85	17	125	0.3	4	6630	106	96	43	1
TRJA105*025#3000	A	1	25	85	17	125	0.3	4	3000	158	142	63	1
TRJA155*025#RJ	A	1.5	25	85	17	125	0.3	6	5460	117	105	47	1
TRJA155*025#3000	A	1.5	25	85	17	125	0.3	6	3000	158	142	63	1
TRJB155*025#RJ	B	1.5	25	85	17	125	0.3	6	5000	130	117	52	1
TRJA225*025#RJ	A	2.2	25	85	17	125	0.41	6	2900	161	145	64	1
TRJA225*025#1600	A	2.2	25	85	17	125	0.41	6	1600	217	195	87	1
TRJB225*025#RJ	B	2.2	25	85	17	125	0.41	6	4550	137	123	55	1
TRJB225*025#1200	B	2.2	25	85	17	125	0.41	6	1200	266	240	106	1
TRJB335*025#RJ	B	3.3	25	85	17	125	0.62	6	3740	151	136	60	1
TRJB335*025#2000	B	3.3	25	85	17	125	0.62	6	2000	206	186	82	1
TRJB475*025#RJ	B	4.7	25	85	17	125	0.88	6	3160	164	148	66	1
TRJB475*025#1000	B	4.7	25	85	17	125	0.88	6	1000	292	262	117	1
TRJB685*025#RJ	B	6.8	25	85	17	125	1.3	6	1500	238	214	95	1
TRJB685*025#1000	B	6.8	25	85	17	125	1.3	6	1000	292	262	117	1
TRJC685*025#RJ	C	6.8	25	85	17	125	1.3	6	1070	321	289	128	1
TRJC685*025#0600	C	6.8	25	85	17	125	1.3	6	600	428	385	171	1
TRJC106*025#RJ	C	10	25	85	17	125	1.9	6	800	371	334	148	1
TRJC106*025#0600	C	10	25	85	17	125	1.9	6	600	428	385	171	1
TRJD106*025#RJ	D	10	25	85	17	125	1.9	6	1200	354	318	141	1
TRJC156*025#RJ	C	15	25	85	17	125	2.8	6	720	391	352	156	1
TRJC156*025#0500	C	15	25	85	17	125	2.8	6	500	469	422	188	1
TRJD156*025#RJ	D	15	25	85	17	125	2.8	6	720	456	411	183	1
TRJD156*025#0300	D	15	25	85	17	125	2.8	6	300	707	636	283	1
TRJD226*025#RJ	D	22	25	85	17	125	4.1	6	650	480	432	192	1
TRJD226*025#0300	D	22	25	85	17	125	4.1	6	300	707	636	283	1
TRJD336*025#RJ	D	33	25	85	17	125	6.2	6	590	504	454	202	1
TRJD336*025#0400	D	33	25	85	17	125	6.2	6	400	612	551	245	1



The Important Information/Disclaimer is incorporated in the catalog where these specifications came from or available online at www.avx.com/disclaimer/ by reference and should be reviewed in full before placing any order.

TRJ Series

Professional Tantalum Chip Capacitor



RATINGS & PART NUMBER REFERENCE

AVX Part No.	Case Size	Capacitance (µF)	Rated Voltage (V)	Rated Temperature (°C)	Category Voltage (V)	Category Temperature (°C)	DCL Max. (µA)	DF Max. (%)	ESR Max. @ 100kHz (mΩ)	100kHz RMS Current (mA)			MSL
										25°C	85°C	125°C	
TRJD476*025#RJ	D	47	25	85	17	125	8.8	6	540	527	474	211	1
TRJD476*025#0250	D	47	25	85	17	125	8.8	6	250	775	697	310	1
TRJE476*025#RJ	E	47	25	85	17	125	8.8	6	540	553	497	221	1 ¹⁾
TRJE476*025#0150	E	47	25	85	17	125	8.8	6	150	1049	944	420	1 ¹⁾
TRJU686*025RRJV	U	68	25	85	17	125	12	30	500	574	517	230	3
TRJU107*025RRJV	U	100	25	85	17	125	18	30	500	574	517	230	3
35 Volt @ 85°C													
TRJA104*035#RJ	A	0.1	35	85	23	125	0.3	4	20000	61	55	24	1
TRJA154*035#RJ	A	0.15	35	85	23	125	0.3	4	16470	67	61	27	1
TRJA154*035#6000	A	0.15	35	85	23	125	0.3	4	6000	112	101	45	1
TRJA224*035#RJ	A	0.22	35	85	23	125	0.3	4	13710	74	67	30	1
TRJA224*035#6000	A	0.22	35	85	23	125	0.3	4	6000	112	101	45	1
TRJA334*035#RJ	A	0.33	35	85	23	125	0.3	4	11280	82	73	33	1
TRJA334*035#6000	A	0.33	35	85	23	125	0.3	4	6000	112	101	45	1
TRJA474*035#RJ	A	0.47	35	85	23	125	0.3	4	9530	89	80	35	1
TRJA474*035#4000	A	0.47	35	85	23	125	0.3	4	4000	137	123	55	1
TRJA684*035#RJ	A	0.68	35	85	23	125	0.3	4	7980	97	87	39	1
TRJA684*035#6000	A	0.68	35	85	23	125	0.3	4	6000	112	101	45	1
TRJA105*035#RJ	A	1	35	85	23	125	0.3	4	6630	106	96	43	1
TRJA105*035#3000	A	1	35	85	23	125	0.3	4	3000	158	142	63	1
TRJB105*035#RJ	B	1	35	85	23	125	0.3	4	3400	158	142	63	1
TRJB105*035#2000	B	1	35	85	23	125	0.3	4	2000	206	186	82	1
TRJA155*035#RJ	A	1.5	35	85	23	125	0.39	6	3100	166	149	66	1
TRJA155*035#2000	A	1.5	35	85	23	125	0.39	6	2000	206	186	82	1
TRJB155*035#RJ	B	1.5	35	85	23	125	0.39	6	5460	125	112	50	1
TRJB155*035#2500	B	1.5	35	85	23	125	0.39	6	2500	184	166	74	1
TRJB225*035#RJ	B	2.2	35	85	23	125	0.58	6	4550	137	123	55	1
TRJB225*035#2000	B	2.2	35	85	23	125	0.58	6	2000	206	186	82	1
TRJB335*035#RJ	B	3.3	35	85	23	125	0.87	6	3740	151	136	60	1
TRJB335*035#1000	B	3.3	35	85	23	125	0.87	6	1000	292	262	117	1
TRJC335*035#RJ	C	3.3	35	85	23	125	0.87	6	1840	245	220	98	1
TRJC335*035#0800	C	3.3	35	85	23	125	0.87	6	800	371	334	148	1
TRJD335*035#RJ	D	3.3	35	85	23	125	0.87	6	2000	274	246	110	1
TRJB475*035#RJ	B	4.7	35	85	23	125	1.2	6	2200	224	201	89	1
TRJB475*035#1500	B	4.7	35	85	23	125	1.2	6	1500	271	244	108	1
TRJC475*035#RJ	C	4.7	35	85	23	125	1.2	6	1410	279	251	112	1
TRJC475*035#0600	C	4.7	35	85	23	125	1.2	6	600	428	385	171	1
TRJD475*035#RJ	D	4.7	35	85	23	125	1.2	6	1500	316	285	126	1
TRJC685*035#RJ	C	6.8	35	85	23	125	1.8	6	1070	321	289	128	1
TRJC685*035#0600	C	6.8	35	85	23	125	1.8	6	600	428	385	171	1
TRJD685*035#RJ	D	6.8	35	85	23	125	1.8	6	1300	340	306	136	1
TRJC106*035#RJ	C	10	35	85	23	125	2.6	6	800	371	334	148	1
TRJC106*035#0600	C	10	35	85	23	125	2.6	6	600	428	385	171	1
TRJD106*035#RJ	D	10	35	85	23	125	2.6	6	800	433	390	173	1
TRJD106*035#0250	D	10	35	85	23	125	2.6	6	250	775	697	310	1
TRJD106*035#0400	D	10	35	85	23	125	2.6	6	400	612	551	245	1
TRJD156*035#RJ	D	15	35	85	23	125	3.9	6	720	456	411	183	1
TRJD156*035#0225	D	15	35	85	23	125	3.9	6	225	816	735	327	1
TRJD226*035#RJ	D	22	35	85	23	125	5.8	6	650	480	432	192	1
TRJD226*035#0200	D	22	35	85	23	125	5.8	6	200	866	779	346	1
TRJD226*035#0400	D	22	35	85	23	125	5.8	6	400	612	551	245	1
TRJE336*035#RJ	E	33	35	85	23	125	8.7	6	590	529	476	212	1 ¹⁾
TRJE336*035#0150	E	33	35	85	23	125	8.7	6	150	1049	944	420	1 ¹⁾
TRJE336*035#0250	E	33	35	85	23	125	8.7	6	250	812	731	325	1 ¹⁾
TRJU476*035RRJV	U	47	35	85	23	125	12.3	10	400	642	578	257	3
TRJU476*035R0200V	U	47	35	85	23	125	12.3	10	200	908	8.17	363	3
50 Volt @ 85°C													
TRJA224*050#RJ	A	0.22	50	85	33	125	0.3	4	7500	100	90	40	1
TRJA224*050#7000	A	0.22	50	85	33	125	0.3	4	7000	104	93	41	1
TRJA334*050#RJ	A	0.33	50	85	33	125	0.3	4	7000	104	93	41	1
TRJB474*050#RJ	B	0.47	50	85	33	125	0.3	4	5000	130	117	52	1
TRJB684*050#RJ	B	0.68	50	85	33	125	0.3	4	4000	146	131	58	1
TRJB684*050#2000	B	0.68	50	85	33	125	0.3	4	2000	206	186	82	1
TRJB105*050#RJ	B	1	50	85	33	125	0.4	4	3400	158	142	63	1
TRJB105*050#2000	B	1	50	85	33	125	0.4	4	2000	206	186	82	1
TRJC105*050#RJ	C	1	50	85	33	125	0.4	4	3000	191	172	77	1
TRJC155*050#RJ	C	1.5	50	85	33	125	0.6	6	2500	210	189	84	1
TRJC155*050#1500	C	1.5	50	85	33	125	0.6	6	1500	271	244	108	1
TRJC225*050#RJ	C	2.2	50	85	33	125	0.8	6	1700	254	229	102	1
TRJC225*050#1000	C	2.2	50	85	33	125	0.8	6	1000	332	298	133	1
TRJD225*050#RJ	D	2.2	50	85	33	125	0.8	4.5	2000	274	246	110	1



TRJ Series

Professional Tantalum Chip Capacitor

RATINGS & PART NUMBER REFERENCE

AVX Part No.	Case Size	Capacitance (µF)	Rated Voltage (V)	Rated Temperature (°C)	Category Voltage (V)	Category Temperature (°C)	DCL Max. (µA)	DF Max. (%)	ESR Max. @ 100kHz (mΩ)	100kHz RMS Current (mA)			MSL
										25°C	85°C	125°C	
TRJD225*050#1200	D	2.2	50	85	33	125	0.8	4.5	1200	354	318	141	1
TRJC335*050#RJ	C	3.3	50	85	33	125	1.2	6	1400	280	252	112	1
TRJC335*050#1000	C	3.3	50	85	33	125	1.2	6	1000	332	298	133	1
TRJD335*050#RJ	D	3.3	50	85	33	125	1.2	4.5	1100	369	332	148	1
TRJD335*050#0800	D	3.3	50	85	33	125	1.2	4.5	800	433	390	173	1
TRJD475*050#RJ	D	4.7	50	85	33	125	1.8	4.5	900	408	367	163	1
TRJD475*050#0600	D	4.7	50	85	33	125	1.8	4.5	600	500	450	200	1
TRJD685*050#RJ	D	6.8	50	85	33	125	2.6	4.5	700	463	417	185	1
TRJE106*050#RJ	E	10	50	85	33	125	3.8	4.5	700	486	437	194	1 ¹⁾
TRJE106*050#0300	E	10	50	85	33	125	3.8	4.5	300	742	667	297	1 ¹⁾
TRJE106*050#0400	E	10	50	85	33	125	3.8	4.5	400	642	578	257	1 ¹⁾
TRJU156*050RRJV	U	15	50	85	33	125	5.6	30	500	574	517	230	3
TRJU226*050RRJV	U	22	50	85	33	125	8.2	30	500	574	517	230	3

¹⁾ Dry pack option (see How to order) is recommended for reduction of stress during soldering. Dry pack parts should be treated as MSL 3.

Moisture Sensitivity Level (MSL) is defined according to J-STD-020.

All technical data relates to an ambient temperature of +25°C. Capacitance and DF are measured at 120Hz, 0.5V RMS with a maximum DC bias of 2.2 volts.

DCL is measured at rated voltage after 5 minutes.

The EIA & CECC standards for low ESR Solid Tantalum Capacitors allow an ESR movement to 1.25 times catalogue limit post mounting.

For typical weight and composition see page 274.

NOTE: AVX reserves the right to supply higher voltage ratings or tighter tolerance part in the same case size, to the same reliability standards.

TRJ Series

Professional Tantalum Chip Capacitor



QUALIFICATION TABLE

TEST	TRJ professional series (Temperature range -55°C to +125°C)									
	Condition			Characteristics						
Endurance	Apply rated voltage (Ur) at 85°C and / or category voltage (Uc) at 125°C for 2000 hours through a circuit impedance of $\leq 0.1\Omega/V$. Stabilize at room temperature for 1-2 hours before measuring.			Visual examination	no visible damage					
				DCL	1.25 x initial limit					
				$\Delta C/C$	within $\pm 10\%$ of initial value					
				DF	initial limit					
				ESR	1.25 x initial limit					
Storage Life	Store at 125°C, no voltage applied, for 2000 hours. Stabilize at room temperature for 1-2 hours before measuring.			Visual examination	no visible damage					
				DCL	1.25 x initial limit					
				$\Delta C/C$	within $\pm 10\%$ of initial value					
				DF	initial limit					
				ESR	1.25 x initial limit					
Humidity	Store at 65°C and 95% relative humidity for 500 hours, with no applied voltage. Stabilize at room temperature and humidity for 1-2 hours before measuring.			Visual examination	no visible damage					
				DCL	1.5 x initial limit					
				$\Delta C/C$	within $\pm 10\%$ of initial value					
				DF	1.2 x initial limit					
				ESR	1.25 x initial limit					
Biased Humidity	Apply rated voltage (Ur) at 85°C, 85% relative humidity for 1000 hours. Stabilize at room temperature and humidity for 1-2 hours before measuring.			Visual examination	no visible damage					
				DCL	2 x initial limit					
				$\Delta C/C$	within $\pm 10\%$ of initial value					
				DF	1.2 x initial limit					
				ESR	1.25 x initial limit					
Temperature Stability	Step	Temperature°C	Duration(min)		+20°C	-55°C	+20°C	+85°C	+125°C	+20°C
	1	+20	15							
	2	-55	15	DCL	IL*	n/a	IL*	10 x IL*	12.5 x IL*	IL*
	3	+20	15	$\Delta C/C$	n/a	+0/-10%	$\pm 5\%$	+10/-0%	+12/-0%	$\pm 5\%$
	4	+85	15	DF	IL*	1.5 x IL*	IL*	1.5 x IL*	2 x IL*	IL*
	5	+125	15							
	6	+20	15	ESR	1.25xIL*	2.5xIL*	1.25xIL*	1.25xIL*	1.25xIL*	1.25xIL*
Surge Voltage	Apply 1.3x category voltage (Uc) at 125°C for 1000 cycles of duration 6 min (30 sec charge, 5 min 30 sec discharge) through a charge / discharge resistance of 1000 Ω			Visual examination	no visible damage					
				DCL	initial limit					
				$\Delta C/C$	within $\pm 5\%$ of initial value					
				DF	initial limit					
				ESR	1.25 x initial limit					
Mechanical Shock	MIL-STD-202, Method 213, Condition F			Visual examination	no visible damage					
				DCL	initial limit					
				$\Delta C/C$	within $\pm 5\%$ of initial value					
				DF	initial limit					
				ESR	1.25 x initial limit					
Vibration	MIL-STD-202, Method 204, Condition D			Visual examination	no visible damage					
				DCL	initial limit					
				$\Delta C/C$	within $\pm 5\%$ of initial value					
				DF	initial limit					
				ESR	1.25 x initial limit					

*Initial Limit

AVX SOLID ELECTROLYTIC CAPACITOR ROADMAP

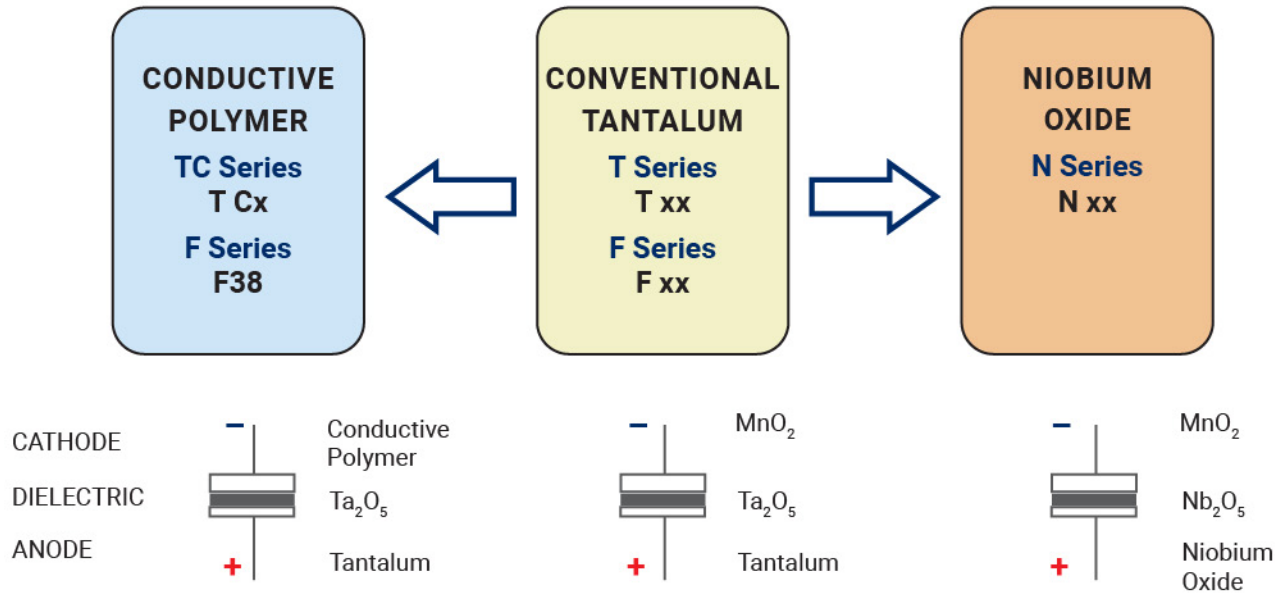

FIVE CAPACITOR CONSTRUCTION STYLES

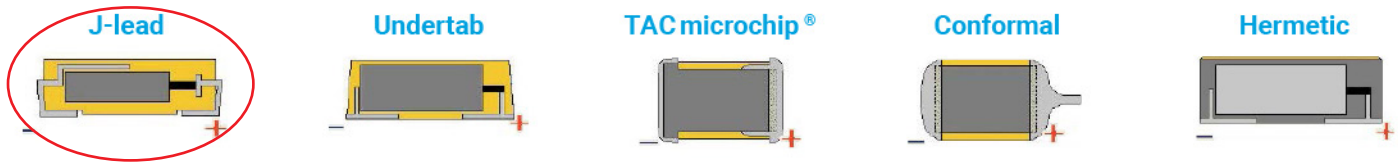

SERIES LINE UP : CONVENTIONAL SMD MnO₂

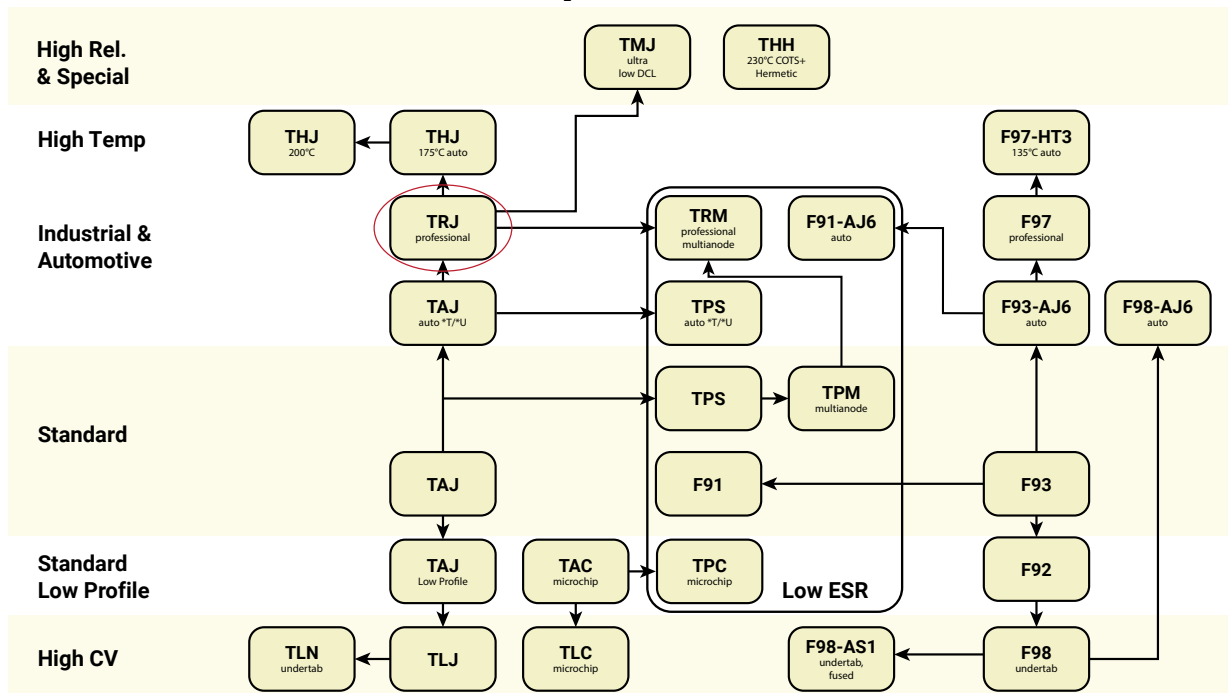

F97 Series

Resin-Molded Chip, Improved Reliability J-Lead



FEATURES

- Compliant to the RoHS3 directive 2015/863/EU
- Compliant to AEC-Q200
- Improved Reliability - FR=0.5%/1000hrs
- 100% Surge Current Tested
- SMD J-lead



APPLICATIONS

- Automotive Electronics(Engine ECU)
- Industrial Equipment

CASE DIMENSIONS:

millimeters (inches)

Code	EIA Code	EIA Metric	L	W ₁	W ₂	H	S
A	1206	3216-18	3.20 ± 0.20 (0.126 ± 0.008)	1.60 ± 0.20 (0.063 ± 0.008)	1.20 ± 0.10 (0.047 ± 0.004)	1.60 ± 0.20 (0.063 ± 0.008)	0.80 ± 0.20 (0.031 ± 0.008)
B	1210	3528-21	3.50 ± 0.20 (0.138 ± 0.008)	2.80 ± 0.20 (0.110 ± 0.008)	2.20 ± 0.10 (0.087 ± 0.004)	1.90 ± 0.20 (0.075 ± 0.008)	0.80 ± 0.20 (0.031 ± 0.008)
C	2312	6032-27	6.00 ± 0.20 (0.236 ± 0.008)	3.20 ± 0.20 (0.126 ± 0.008)	2.20 ± 0.10 (0.087 ± 0.004)	2.50 ± 0.20 (0.098 ± 0.008)	1.30 ± 0.20 (0.051 ± 0.008)
N	2917	7343-30	7.30 ± 0.20 (0.287 ± 0.008)	4.30 ± 0.20 (0.169 ± 0.008)	2.40 ± 0.10 (0.094 ± 0.004)	2.80 ± 0.20 (0.110 ± 0.008)	1.30 ± 0.20 (0.051 ± 0.008)

A, B CASE

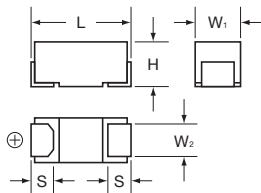

C, N CASE

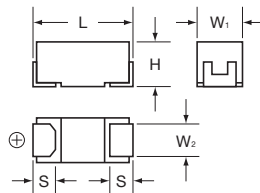

MARKING

A CASE

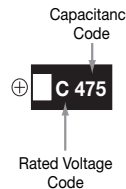

B CASE

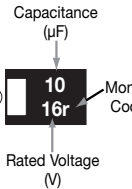

C CASE

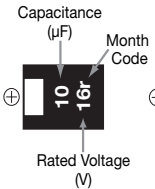

N CASE

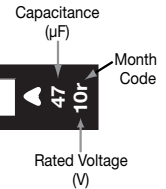

HOW TO ORDER

F97

Type

1C

Rated Voltage

335

Capacitance Code

pF code: 1st two digits represent significant figures, 3rd digit represents multiplier (number of zeros to follow)

M

Tolerance
K = ±10%
M = ±20%

A

Case Size
See table above

□

Packaging
See Tape & Reel Packaging Section

TECHNICAL SPECIFICATIONS

Category Temperature Range:	-55 to +125°C
Rated Temperature:	+85°C
Capacitance Tolerance:	±20%, ±10% at 120Hz
Dissipation Factor:	Refer to next page
ESR 100kHz:	Refer to next page
Leakage Current:	After 1 minute's application of rated voltage, leakage current at 20°C is not more than 0.01CV or 0.5µA, whichever is greater. After 1 minute's application of rated voltage, leakage current at 85°C is not more than 0.1CV or 5µA, whichever is greater. After 1 minute's application of derated voltage, leakage current at 125°C is not more than 0.125CV or 6.3µA, whichever is greater.
Capacitance Change By Temperature	+15% Max. at +125°C +10% Max. at +85°C -10% Max. at -55°C

F97 Series

Resin-Molded Chip, Improved Reliability J-Lead

CAPACITANCE AND RATED VOLTAGE RANGE (LETTER DENOTES CASE SIZE)

Capacitance		Rated Voltage					
µF	Code	6.3V (0J)	10V (1A)	16V (1C)	20V (1D)	25V (1E)	35V (1V)
0.33	334						A
0.47	474						A
0.68	684					A	A
1.0	105			A	A	A	B
1.5	155				A		B
2.2	225		A	A	A	B	B
3.3	335	A	A	A	B	B	C
4.7	475		A/B	A/B	A/B		C
6.8	685		B	B		C	N
10	106		A/B	A/B/C	C	C/N	N
15	156	B	B		N	N	
22	226	A/B	A/B	B/C/N	C/N	N	
33	336	A/C	B/C/N	B/C/N			
47	476	B/C	B/C/N	C/N			
68	686		N				
100	107		C				
150	157	C					

Released ratings

Please contact to your local AVX sales office when these series are being designed in your application.

Voltage vs Temperature Rating

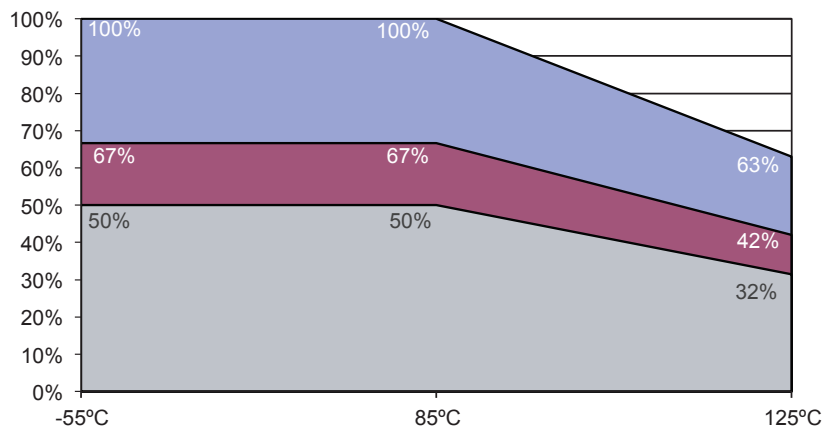

- Rated Voltage
- Recommended Applications Voltage in General Circuit
- Recommended Applications Voltage in Low Impedance Circuit

F97 Series

Resin-Molded Chip, Improved Reliability J-Lead



RATINGS & PART NUMBER REFERENCE

AVX Part No.	Case Size	Capacitance (µF)	Rated Voltage (V)	DCL (µA)	DF @ 120Hz (%)	ESR @ 100kHz (Ω)	100kHz RMS Current (mA)			*1 ΔC/C (%)	MSL
							25°C	85°C	125°C		
6.3 Volt											
F970J335#AA	A	3.3	6.3	0.5	4	4.5	129	116	52	*	3
F970J156#BA	B	15	6.3	0.9	6	2.0	206	186	82	*	3
F970J226#AA	A	22	6.3	1.4	12	2.5	173	156	69	*	3
F970J226#BA	B	22	6.3	1.4	8	1.9	212	190	85	*	3
F970J336#AA	A	33	6.3	2.1	12	2.5	173	156	69	*	3
F970J336#CC	C	33	6.3	2.1	6	1.1	316	285	126	*	3
F970J476#BA	B	47	6.3	3.0	8	1.0	292	262	117	*	3
F970J476#CC	C	47	6.3	3.0	6	0.9	350	315	140	*	3
F970J157#CC	C	150	6.3	9.5	12	0.7	396	357	159	*	3
10 Volt											
F971A225#AA	A	2.2	10	0.5	4	5.0	122	110	49	*	3
F971A335#AA	A	3.3	10	0.5	4	4.5	129	116	52	*	3
F971A475#AA	A	4.7	10	0.5	6	4.0	137	123	55	*	3
F971A475#BA	B	4.7	10	0.5	6	2.8	174	157	70	*	3
F971A685#BA	B	6.8	10	0.7	6	2.5	184	166	74	*	3
F971A106#AA	A	10	10	1.0	6	3.0	158	142	63	*	3
F971A106#BA	B	10	10	1.0	6	2.0	206	186	82	*	3
F971A156#BA	B	15	10	1.5	6	2.0	206	186	82	*	3
F971A226#AA	A	22	10	2.2	15	3.0	158	142	63	*	3
F971A226#BA	B	22	10	2.2	8	1.9	212	190	85	*	3
F971A336#BA	B	33	10	3.3	8	1.9	212	190	85	*	3
F971A336#CC	C	33	10	3.3	6	1.1	316	285	126	*	3
F971A336#NC	N	33	10	3.3	6	0.7	463	417	185	*	3
F971A476#BA	B	47	10	4.7	10	1.0	292	262	117	*	3
F971A476#CC	C	47	10	4.7	8	0.9	350	315	140	*	3
F971A476#NC	N	47	10	4.7	6	0.7	463	417	185	*	3
F971A686#NC	N	68	10	6.8	6	0.6	500	450	200	*	3
F971A107#CC	C	100	10	10.0	10	0.7	396	357	159	*	3
16 Volt											
F971C105#AA	A	1	16	0.5	4	7.5	100	90	40	*	3
F971C225#AA	A	2.2	16	0.5	4	5.0	122	110	49	*	3
F971C335#AA	A	3.3	16	0.5	4	4.5	129	116	52	*	3
F971C475#AA	A	4.7	16	0.8	8	4.0	137	123	55	*	3
F971C475#BA	B	4.7	16	0.8	6	2.8	174	157	70	*	3
F971C685#BA	B	6.8	16	1.1	6	2.5	184	166	74	*	3
F971C106#AA	A	10	16	1.6	8	3.5	146	132	59	*	3
F971C106#BA	B	10	16	1.6	6	2.1	201	181	80	*	3
F971C106#CC	C	10	16	1.6	6	1.5	271	244	108	*	3
F971C226#BA	B	22	16	3.5	8	1.9	212	190	85	*	3
F971C226#CC	C	22	16	3.5	8	1.1	316	285	126	*	3
F971C226#NC	N	22	16	3.5	6	0.7	463	417	185	*	3
F971C336#BA	B	33	16	5.3	10	2.1	201	181	80	*	3
F971C336#CC	C	33	16	5.3	8	1.1	316	285	126	*	3
F971C336#NC	N	33	16	5.3	6	0.7	463	417	185	*	3
F971C476#CC	C	47	16	7.5	10	1.1	316	285	126	*	3
F971C476#NC	N	47	16	7.5	8	0.7	463	417	185	*	3
20 Volt											
F971D105#AA	A	1	20	0.5	4	7.5	100	90	40	*	3
F971D155#AA	A	1.5	20	0.5	4	6.7	106	95	42	*	3
F971D225#AA	A	2.2	20	0.5	6	6.3	109	98	44	*	3
F971D335#BA	B	3.3	20	0.7	4	3.1	166	146	66	*	3
F971D475#AA	A	4.7	20	0.9	8	4.0	137	123	55	*	3
F971D475#BA	B	4.7	20	0.9	6	2.8	174	157	70	*	3
F971D685#CC	C	6.8	20	1.4	6	1.8	247	222	99	*	3
F971D106#CC	C	10	20	2.0	6	1.5	271	244	108	*	3
F971D156#NC	N	15	20	3.0	6	0.7	463	417	185	*	3
F971D226#CC	C	22	20	4.4	8	1.1	316	285	126	*	3
F971D226#NC	N	22	20	4.4	6	0.7	463	417	185	*	3
25 Volt											
F971E684#AA	A	0.68	25	0.5	4	7.6	99	89	40	*	3
F971E105#AA	A	1	25	0.5	4	7.5	100	90	40	*	3
F971E225#BA	B	2.2	25	0.6	4	3.8	150	135	60	*	3
F971E335#BA	B	3.3	25	0.8	4	3.5	156	140	62	*	3
F971E685#CC	C	6.8	25	1.7	6	1.8	247	222	99	*	3
F971E106#NC	N	10	25	2.5	6	1.0	387	349	155	*	3
F971E156#NC	N	15	25	3.8	6	0.7	463	417	185	*	3
F971E226#NC	N	22	25	5.5	6	0.7	463	417	185	*	3

F97 Series

Resin-Molded Chip, Improved Reliability J-Lead

RATINGS & PART NUMBER REFERENCE

AVX Part No.	Case Size	Capacitance (μF)	Rated Voltage (V)	DCL (μA)	DF @ 120Hz (%)	ESR @ 100kHz (Ω)	100kHz RMS Current (mA)			*1 ΔC/C (%)	MSL
							25°C	85°C	125°C		
35 Volt											
F971V334#AA	A	0.33	35	0.5	4	12.0	79	71	32	*	3
F971V474#AA	A	0.47	35	0.5	4	10.0	87	78	35	*	3
F971V684#AA	A	0.68	35	0.5	4	7.6	99	89	40	*	3
F971V105#BA	B	1	35	0.5	4	4.0	146	131	58	*	3
F971V155#BA	B	1.5	35	0.5	4	4.0	146	131	58	*	3
F971V225#BA	B	2.2	35	0.8	4	3.8	150	135	60	*	3
F971V335#CC	C	3.3	35	1.2	4	2.0	235	211	94	*	3
F971V475#CC	C	4.7	35	1.6	6	1.8	247	222	99	*	3
F971V685#NC	N	6.8	35	2.4	6	1.0	387	349	155	*	3
F971V106#NC	N	10	35	3.5	6	1.0	387	349	155	*	3

*1: ΔC/C Marked "**"

#: "M" for ±20% tolerance, "K" for ± 10% tolerance.

Moisture Sensitivity Level (MSL) is defined according to J-STD-020.

Item	All Case (%)
Damp Heat	±10
Temperature cycles	±5
Resistance soldering heat	±5
Surge	±5
Endurance	±10
Load Humidity	±10

QUALIFICATION TABLE

TEST	F97 series (Temperature range -55°C to +125°C)	
	Condition	
Damp Heat (Steady State)	At 85°C, 85% R.H., 1000 hours (No voltage applied) Capacitance Change Refer to page 110 (*1) Dissipation Factor Initial specified value or less Leakage Current 125% or less than the initial specified value	
Load Humidity	After 1000 hour's application of rated voltage in series with a 33Ω resistor at 85°C, 85% R.H., capacitors meet the characteristics requirements table below. Capacitance Change Refer to page 110 (*1) Dissipation Factor 120% or less than the initial specified value Leakage Current 200% of less than the initial specified value	
Temperature Cycles	At -55°C / +125°C, 30 minutes each, 1000 cycles Capacitance Change Refer to page 109 (*1) Dissipation Factor Initial specified value or less Leakage Current Initial specified value or less	
Resistance to Soldering Heat	10 seconds reflow at 260°C, 5 seconds immersion at 260°C. Capacitance Change Refer to page 110 (*1) Dissipation Factor Initial specified value or less Leakage Current Initial specified value or less	
Solderability	After immersing capacitors completely into a solder pot at 245°C for 2 to 3 seconds, more than 3/4 of their electrode area shall remain covered with new solder.	
Surge	After application of surge voltage in series with a 33Ω resistor at the rate of 30 seconds ON, 30 seconds OFF, for 1000 successive test cycles at 85°C, capacitors shall meet the characteristic requirements in the table above. Capacitance Change Refer to page 110 (*1) Dissipation Factor Initial specified value or less Leakage Current Initial specified value or less	
Endurance	After 2000 hours' application of rated voltage in series with a 3Ω resistor at 85°C, or derated voltage in series with a 30 resistor at 125°C, capacitors shall meet the characteristic requirements in the table above. Capacitance Change Refer to page 110 (*1) Dissipation Factor Initial specified value or less Leakage Current Initial specified value or less	
Shear Test	After applying the pressure load of 17.7N for 60 seconds horizontally to the center of capacitor side body which has no electrode and has been soldered beforehand on a substrate, there shall be found neither exfoliation nor its sign at the terminal electrode	
Terminal Strength	Keeping a capacitor surface-mounted on a substrate upside down and supporting the substrate at both of the opposite bottom points 45mm apart from the center of capacitor, the pressure strength is applied with a specified jig at the center of the substrate so that substrate may bend by 1mm as illustrated. Then, there shall be found no remarkable abnormality on the capacitor terminals.	
Failure Rate	0.5% per 1000 hours at 85°C, V _R with 0.1Ω/V series impedance, 60% confidence level.	

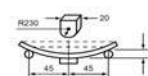
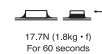

F97 Series

Resin-Molded Chip, Improved Reliability J-Lead



AVX SOLID ELECTROLYTIC CAPACITOR ROADMAP

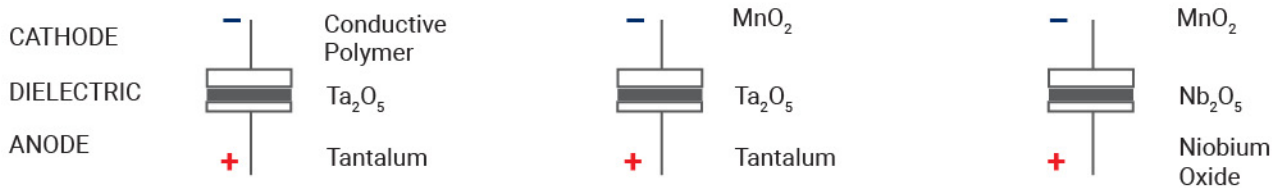
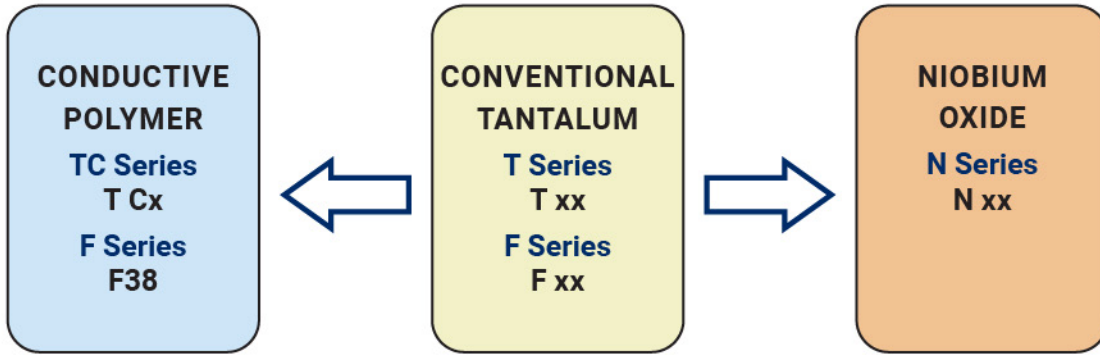

FIVE CAPACITOR CONSTRUCTION STYLES

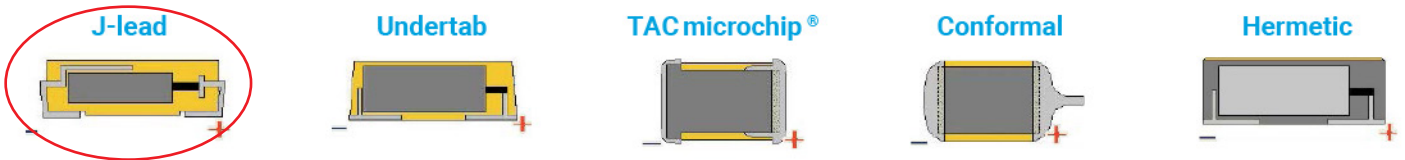

SERIES LINE UP : CONVENTIONAL SMD MnO₂

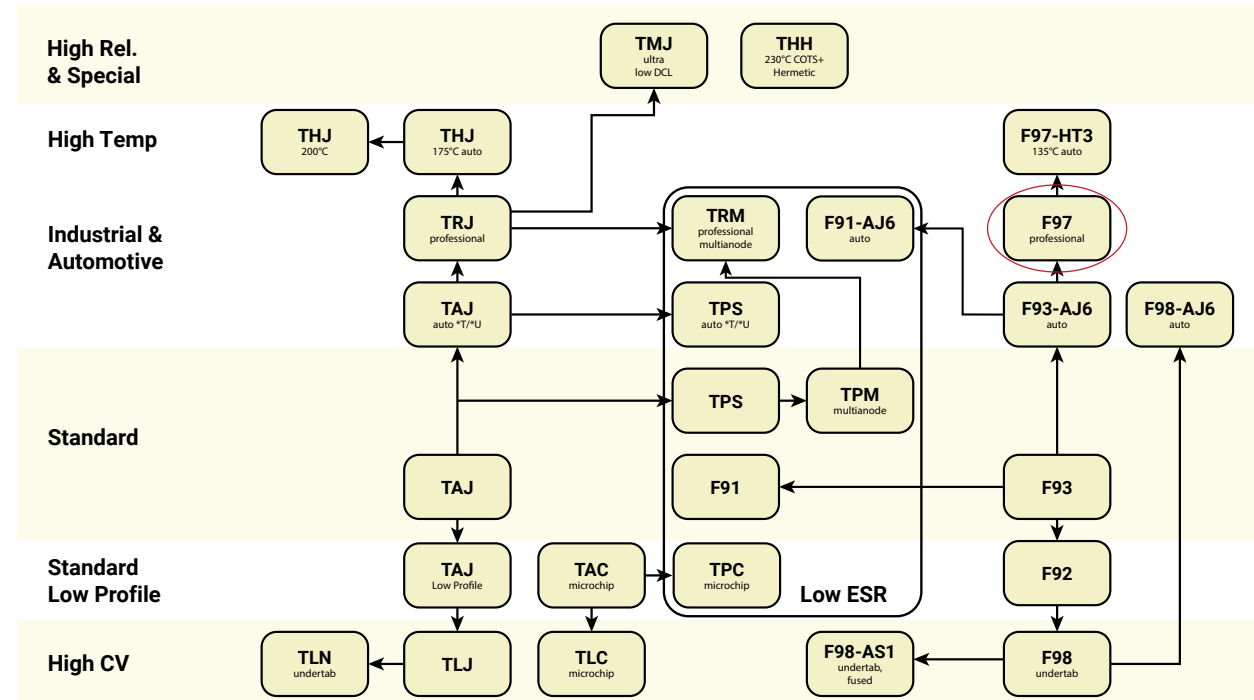

F97-HT3 Series

High Temperature 135°C, Resin-molded Chip, High Reliability



FEATURES

- Compliant to the RoHS3 directive 2015/863/EU
- High Temperature 135°C
- AEC-Q200 Qualified
- Failure Rate Level 0.5%/ 1000 hrs
- 100% Surge Current Tested



APPLICATIONS

- Automotive Electronics (Engine ECU, Transmission, Oil Pump)
- Industrial Equipment

CASE DIMENSIONS:

millimeters (inches)

Code	EIA Code	EIA Metric	L	W ₁	W ₂	H	S
A	1206	3216-18	3.20 ± 0.20 (0.126 ± 0.008)	1.60 ± 0.20 (0.063 ± 0.008)	1.20 ± 0.10 (0.047 ± 0.004)	1.60 ± 0.20 (0.063 ± 0.008)	0.80 ± 0.20 (0.031 ± 0.008)
B	1210	3528-21	3.50 ± 0.20 (0.138 ± 0.008)	2.80 ± 0.20 (0.110 ± 0.008)	2.20 ± 0.10 (0.087 ± 0.004)	1.90 ± 0.20 (0.075 ± 0.008)	0.80 ± 0.20 (0.031 ± 0.008)
C	2312	6032-27	6.00 ± 0.20 (0.236 ± 0.008)	3.20 ± 0.20 (0.126 ± 0.008)	2.20 ± 0.10 (0.087 ± 0.004)	2.50 ± 0.20 (0.098 ± 0.008)	1.30 ± 0.20 (0.051 ± 0.008)
N	2917	7343-30	7.30 ± 0.20 (0.287 ± 0.008)	4.30 ± 0.20 (0.169 ± 0.008)	2.40 ± 0.10 (0.094 ± 0.004)	2.80 ± 0.20 (0.110 ± 0.008)	1.30 ± 0.20 (0.051 ± 0.008)

A, B CASE

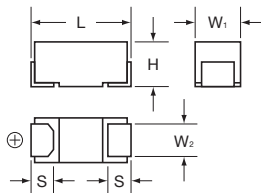

C, N CASE

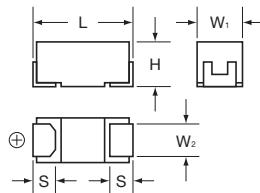

MARKING

A CASE

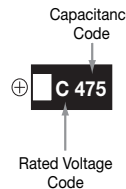

B CASE

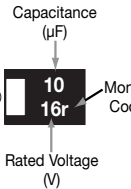

C CASE

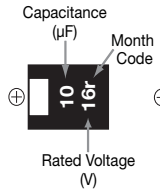

N CASE

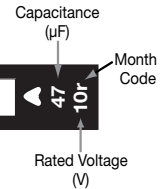

HOW TO ORDER

F97

Type

1C

Rated Voltage

335

Capacitance Code

pF code: 1st two digits represent significant figures, 3rd digit represents multiplier (number of zeros to follow)

M

Tolerance
K = ±10%
M = ±20%

A

Case Size
See table above

□

Packaging
See Tape & Reel Packaging Section

HT3

Temperature Range
135°C MAX

TECHNICAL SPECIFICATIONS

Category Temperature Range	-55 to +135°C
Rated Temperature	+95°C
Capacitance Tolerance	±20%, ±10% at 120Hz
Dissipation Factor	Refer to next page
ESR 100kHz	Refer to next page
Leakage Current*	After 1 minute's application of rated voltage, leakage current at 20°C is not more than 0.01CV or 0.5µA, whichever is greater. After 1 minute's application of rated voltage, leakage current at 95°C is not more than 0.1CV or 5µA, whichever is greater. After 1 minute's application of derated voltage, leakage current at 135°C is not more than 0.125CV or 6.3µA, whichever is greater.
Capacitance Change By Temperature	+15% Max. at +125°C +10% Max. at +85°C -10% Max. at -55°C

*As for the surge voltage and derated voltage at 135°C, refer to page precautions for details.

F97-HT3 Series

High Temperature 135°C, Resin-molded Chip, High Reliability



CAPACITANCE AND RATED VOLTAGE RANGE (LETTER DENOTES CASE SIZE)

Capacitance		Rated Voltage					
µF	Code	6.3V (0J)	10V (1A)	16V (1C)	20V (1D)	25V (1E)	35V (1V)
0.33	334						A
0.47	474						A
0.68	684					A	A
1	105			A	A	A	B
1.5	155				A		B
2.2	225			A		B	B
3.3	335	A	A	A	B	B	C
4.7	475		A/B	A/B	A		C
6.8	685					C	N
10	106		A/B	A/B/C		C/N	N
15	156	B	B			N	
22	226		A/B	B/C	C/N		
33	336	A/C	B/C	B/C/N			
47	476	B	B/C/N	C/N			
68	686		N				
100	107		C				

Released ratings

Please contact to your local AVX sales office when these series are being designed in your application.

Voltage vs Temperature Rating

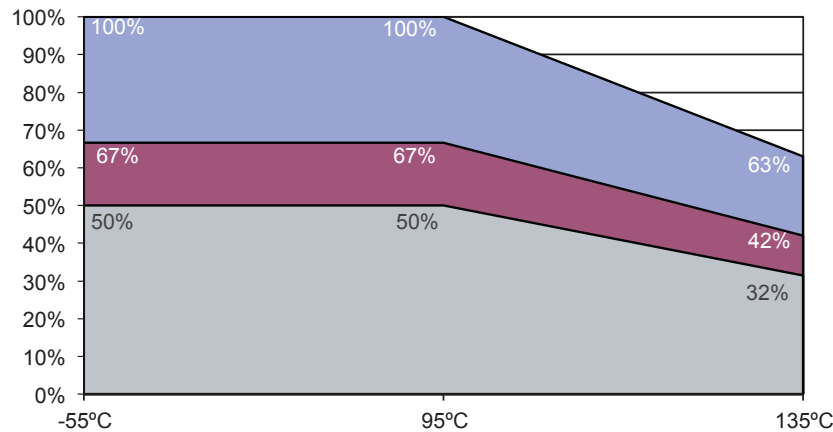

- Rated Voltage
- Recommended Applications Voltage in General Circuit
- Recommended Applications Voltage in Low Impedance Circuit

F97-HT3 Series

High Temperature 135°C, Resin-molded Chip, High Reliability



RATINGS & PART NUMBER REFERENCE

AVX Part No.	Case Size	Capacitance (µF)	Rated Voltage (V)	Leakage Current (µA)	DF @ 120Hz (%)	ESR @ 100kHz (Ω)	100kHz RMS Current (mA)			*1 ΔC/C (%)	MSL
							25°C	95°C	135°C		
6.3 Volt											
F970J335#AAHT3	A	3.3	6.3	0.5	4	4.5	129	116	52	*	3
F970J156#BAHT3	B	15	6.3	0.9	6	2.0	206	186	82	*	3
F970J336#AAHT3	A	33	6.3	2.1	12	2.5	173	156	69	*	3
F970J336#CCHT3	C	33	6.3	2.1	6	1.1	316	285	126	*	3
F970J476#BAHT3	B	47	6.3	3.0	8	1.0	292	262	117	*	3
10 Volt											
F971A335#AAHT3	A	3.3	10	0.5	4	4.5	129	116	52	*	3
F971A475#AAHT3	A	4.7	10	0.5	6	4.0	137	123	55	*	3
F971A475#BAHT3	B	4.7	10	0.5	6	2.8	174	157	70	*	3
F971A106#AAHT3	A	10	10	1.0	6	3.0	158	142	63	*	3
F971A106#BAHT3	B	10	10	1.0	6	2.0	206	186	82	*	3
F971A156#BAHT3	B	15	10	1.5	6	2.0	206	186	82	*	3
F971A226#AAHT3	A	22	10	2.2	15	3.0	158	142	63	*	3
F971A226#BAHT3	B	22	10	2.2	8	1.9	212	190	85	*	3
F971A336#BAHT3	B	33	10	3.3	8	1.9	212	190	85	*	3
F971A336#CCHT3	C	33	10	3.3	6	1.1	316	285	126	*	3
F971A476#BAHT3	B	47	10	4.7	10	1.0	292	262	117	*	3
F971A476#CCHT3	C	47	10	4.7	8	0.9	350	315	140	*	3
F971A476#NCHT3	N	47	10	4.7	6	0.7	463	417	185	*	3
F971A686#NCHT3	N	68	10	6.8	6	0.6	500	450	200	*	3
F971A107#CCHT3	C	100	10	10.0	10	0.7	396	357	159	*	3
16 Volt											
F971C105#AAHT3	A	1	16	0.5	4	7.5	100	90	40	*	3
F971C225#AAHT3	A	2.2	16	0.5	4	5.0	122	110	49	*	3
F971C335#AAHT3	A	3.3	16	0.5	4	4.5	129	116	52	*	3
F971C475#AAHT3	A	4.7	16	0.8	8	4.0	137	123	55	*	3
F971C475#BAHT3	B	4.7	16	0.8	6	2.8	174	157	70	*	3
F971C106#AAHT3	A	10	16	1.6	8	3.5	146	132	59	*	3
F971C106#BAHT3	B	10	16	1.6	6	2.1	201	181	80	*	3
F971C106#CCHT3	C	10	16	1.6	6	1.5	271	244	108	*	3
F971C226#BAHT3	B	22	16	3.5	8	1.9	212	190	85	*	3
F971C226#CCHT3	C	22	16	3.5	8	1.1	316	285	126	*	3
F971C336#BAHT3	B	33	16	5.3	10	2.1	201	181	80	*	3
F971C336#CCHT3	C	33	16	5.3	8	1.1	316	285	126	*	3
F971C336#NCHT3	N	33	16	5.3	6	0.7	463	417	185	*	3
F971C476#CCHT3	C	47	16	7.5	10	1.1	316	285	126	*	3
F971C476#NCHT3	N	47	16	7.5	8	0.7	463	417	185	*	3
20 Volt											
F971D105#AAHT3	A	1	20	0.5	4	7.5	100	90	40	*	3
F971D155#AAHT3	A	1.5	20	0.5	4	6.7	106	95	42	*	3
F971D335#BAHT3	B	3.3	20	0.7	4	3.1	166	149	66	*	3
F971D475#AAHT3	A	4.7	20	0.9	8	4.0	137	123	55	*	3
F971D226#CCHT3	C	22	20	4.4	8	1.1	316	285	126	*	3
F971D226#NCHT3	N	22	20	4.4	6	0.7	463	417	185	*	3
25 Volt											
F971E684#AAHT3	A	0.68	25	0.5	4	7.6	99	89	40	*	3
F971E105#AAHT3	A	1	25	0.5	4	7.5	100	90	40	*	3
F971E225#BAHT3	B	2.2	25	0.6	4	3.8	150	135	60	*	3
F971E335#BAHT3	B	3.3	25	0.8	4	3.5	156	140	62	*	3
F971E685#CCHT3	C	6.8	25	1.7	6	1.8	247	222	99	*	3
F971E106#CCHT3	C	10	25	2.5	6	1.6	262	236	105	*	3
F971E106#NCHT3	N	10	25	2.5	6	1.0	387	349	155	*	3
F971E156#NCHT3	N	15	25	3.8	6	0.7	463	417	185	*	3
35 Volt											
F971V334#AAHT3	A	0.33	35	0.5	4	12.0	79	71	32	*	3
F971V474#AAHT3	A	0.47	35	0.5	4	10.0	87	78	35	*	3
F971V684#AAHT3	A	0.68	35	0.5	4	7.6	99	89	40	*	3
F971V105#BAHT3	B	1	35	0.5	4	4.0	146	131	58	*	3
F971V155#BAHT3	B	1.5	35	0.5	4	4.0	146	131	58	*	3
F971V225#BAHT3	B	2.2	35	0.8	4	3.8	150	135	60	*	3
F971V335#CCHT3	C	3.3	35	1.2	4	2.0	235	211	94	*	3
F971V475#CCHT3	C	4.7	35	1.6	6	1.8	247	222	99	*	3
F971V685#NCHT3	N	6.8	35	2.4	6	1.0	387	349	155	*	3
F971V106#NCHT3	N	10	35	3.5	6	1.0	387	349	155	*	3

Item	All Case (%)
Damp Heat	±10
Temperature cycles	±5
Resistance soldering heat	±5
Surge	±5
Endurance	±10
Load Humidity	±10

*1: ΔC/C Marked "**"
 #: "M" for ±20% tolerance, "K" for ±10% tolerance.
 Moisture Sensitivity Level (MSL) is defined according to J-STD-020.



The Important Information/Disclaimer is incorporated in the catalog where these specifications came from or available online at www.avx.com/disclaimer/ by reference and should be reviewed in full before placing any order.

F97-HT3 Series

High Temperature 135°C, Resin-molded Chip, High Reliability

QUALIFICATION TABLE

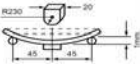
TEST	F97-HT3 series (Temperature range -55°C to +135°C)	
	Condition	
Damp Heat (Steady State)	At 85°C, 85% RH For 1000 hours (No voltage applied) Capacitance Change Refer to page 115 (*1) Dissipation Factor Initial specified value or less Leakage Current 125% or less than the initial specified value	
Load Humidity	After 1000 hours application of rated voltage in series with a 33Ω resistor at 85°C, 85% RH capacitors meet the characteristics requirements table below. Capacitance Change Refer to page 115 (*1) Dissipation Factor 120% or less than the Initial specified value Leakage Current..... 200% or less than the initial specified value	
Temperature Cycles	At -55°C / +135°C, For 30 minutes each, 1000 cycles Capacitance Change Refer to page 115 (*1) Dissipation Factor Initial specified value or less Leakage Current..... Initial specified value or less	
Resistance to Soldering Heat	10 seconds reflow at 260°C, 5 seconds immersion at 260°C. Capacitance Change Refer to page 115 (*1) Dissipation Factor Initial specified value or less Leakage Current..... Initial specified value or less	
Solderability	After immersing capacitors completely into a solder pot at 245°C for 2 to 3 seconds, more than 3/4 of their electrode area shall remain covered with new solder.	
Surge*	After application of surge in series with a 33Ω resistor at the rate of 30 seconds ON, 30 seconds OFF, for 1000 successive test cycles at 95°C, capacitors shall meet the characteristic requirements table below. Capacitance Change Refer to page 115 (*1) Dissipation Factor Initial specified value or less Leakage Current..... Initial specified value or less	
Endurance*	After 2000 hours application of rated voltage in series with a 3Ω resistor at 95°C, or derated voltage in series with a 3Ω resistor at 135°C, capacitors shall meet the characteristic requirements table below. Capacitance Change Refer to page 115 (*1) Dissipation Factor Initial specified value or less Leakage Current..... Initial specified value or less	
Shear Test	After applying the pressure load of 17.7N for 60 seconds horizontally to the center of capacitor side body which has no electrode and has been soldered beforehand on a substrate, there shall be found neither exfoliation nor its sign at the terminal electrode.	
Terminal Strength	Keeping a capacitor surface-mounted on a substrate upside down and supporting the substrate at both of the opposite bottom points 45mm apart from the center of capacitor, the pressure strength is applied with a specified jig at the center of the substrate so that substrate may bend by 1mm as illustrated. Then, there shall be found no remarkable abnormality on the capacitor terminals.	

* As for the surge voltage and derated voltage at 135°C, refer to page precautions for details.

F97-HT3 Series

High Temperature 135°C, Resin-molded Chip, High Reliability



AVX SOLID ELECTROLYTIC CAPACITOR ROADMAP

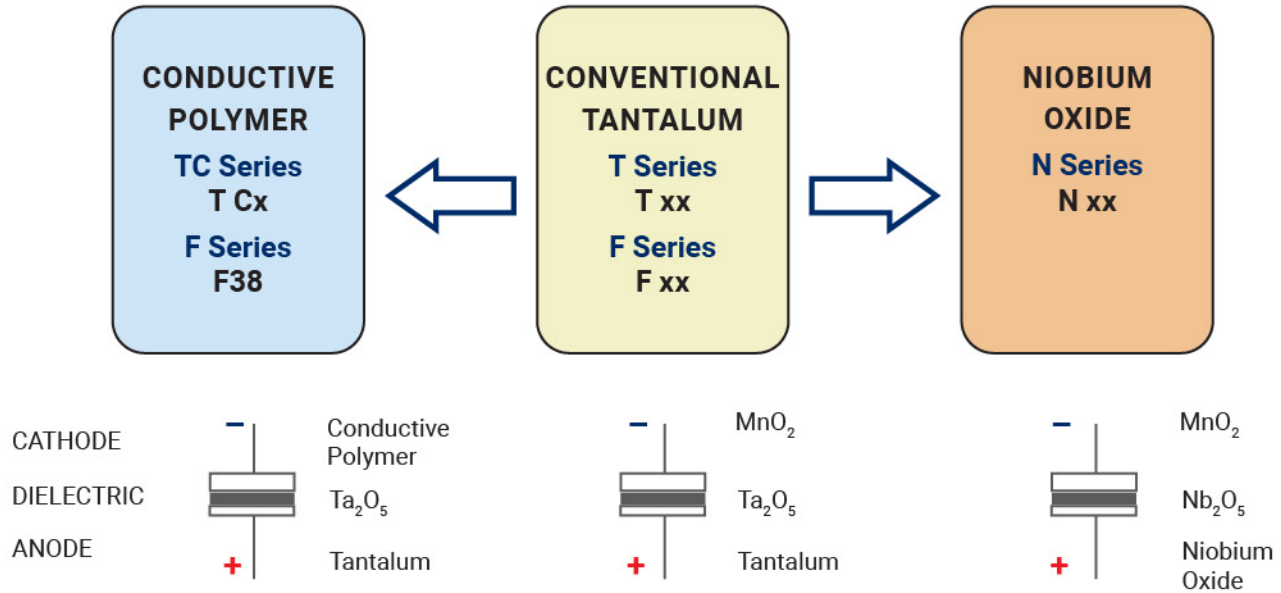

FIVE CAPACITOR CONSTRUCTION STYLES

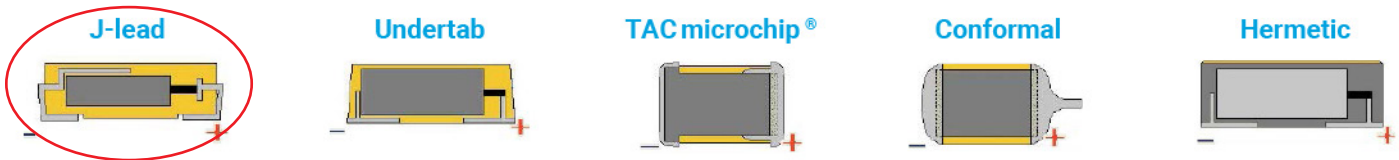

SERIES LINE UP : CONVENTIONAL SMD MnO₂

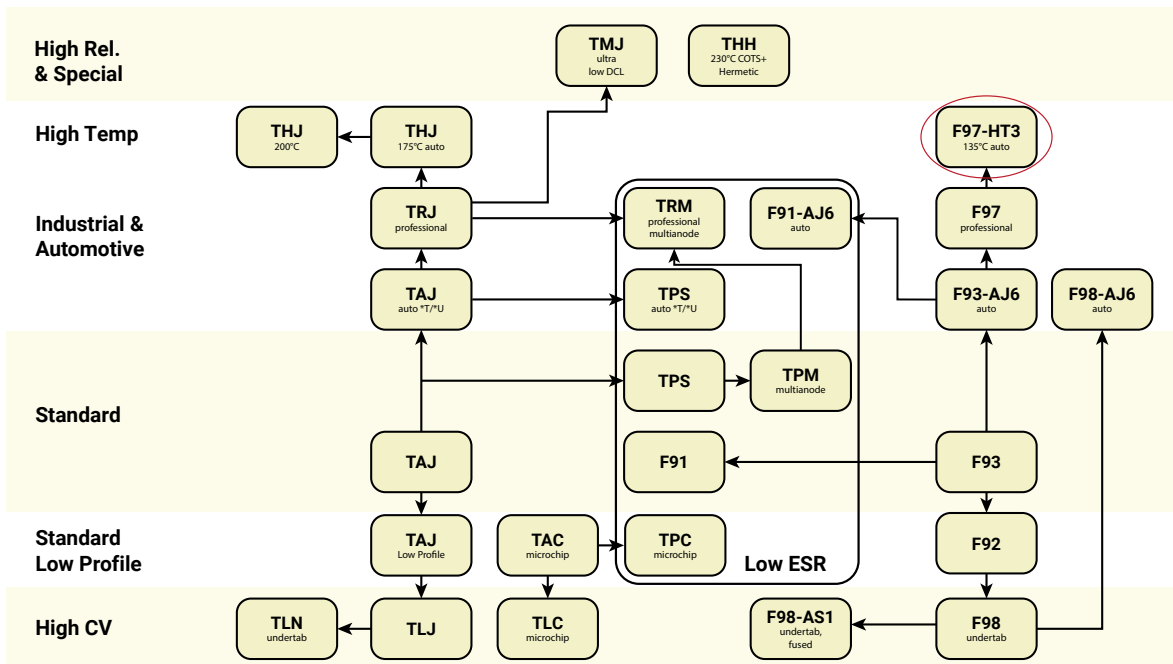

TRM Professional Multianode

Tantalum Ultra Low ESR Capacitor

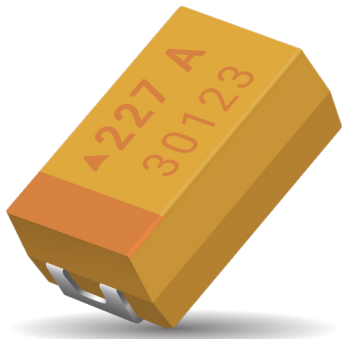

FEATURES

- Improved Reliability – 0.5%/1khrs (Twice Better than Standard)
- DCL Reduced by 25% to 0.0075 CV
- Robust Against Higher Thermo-mechanical Stresses During Assembly Process
- Multi-anode Construction
- Super Low ESR
- 100% Surge Current Tested
- CV Range 4.7-1500µF / 2.5-50V
- “Mirror” Construction Used With D case Capacitors Reduces ESL to Half
- Automotive, Medical, Aerospace, Military and Other Hi-End Applications



SnPb termination option is not RoHS compliant.

APPLICATIONS

- Automotive, Avionics and Industrial High Power DC/DC Convertors

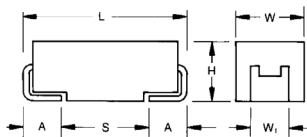

MULTIANODE CONSTRUCTION

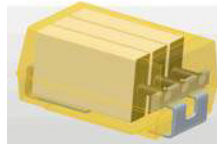

MULTIANODE TRM D LOW SELF INDUCTANCE CONSTRUCTION “MIRROR” DESIGN

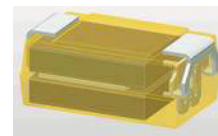

MARKING

D, E, U CASE

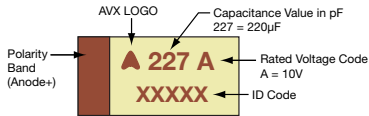

CASE DIMENSIONS:

millimeters (inches)

Code	EIA Code	EIA Metric	L±0.20 (0.008)	W±0.20 (0.008) -0.10 (0.004)	H±0.20 (0.008) -0.10 (0.004)	W ₁ ±0.20 (0.008)	A±0.30 (0.012) -0.20 (0.008)	S Min.
D	2917	7343-31	7.30 (0.287)	4.30 (0.169)	2.90 (0.114)	2.40 (0.094)	1.30 (0.051)	4.40 (0.173)
E	2917	7343-43	7.30 (0.287)	4.30 (0.169)	4.10 (0.162)	2.40 (0.094)	1.30 (0.051)	4.40 (0.173)
U	2924	7361-43	7.30 (0.287)	6.10 (0.240)	4.10 (0.162)	3.10 (0.122)	1.30 (0.051)	4.40 (0.173)

W₁ dimension applies to the termination width for A dimensional area only.

HOW TO ORDER

TRM	E	108	*	004	R	0023
Type	Case Size See table above	Capacitance Code pF code: 1st two digits represent significant figures, 3rd digit represents multiplier (number of zeros to follow)	Tolerance K = ±10% M = ±20%	Rated DC Voltage 002 = 2.5Vdc 004 = 4Vdc 006 = 6.3Vdc 010 = 10Vdc 012 = 12Vdc 016 = 16Vdc 020 = 20Vdc 025 = 25Vdc 035 = 35Vdc 050 = 50Vdc	Packaging R = Pure Tin 7" Reel S = Pure Tin 13" Reel H = Tin Lead 7" Reel (Contact Manufacturer) K = Tin Lead 13" Reel (Contact Manufacturer) H, K = Non RoHS	ESR in mΩ

TECHNICAL SPECIFICATIONS

Technical Data:	All technical data relate to an ambient temperature of +25°C										
Capacitance Range:	4.7 µF to 1500 µF										
Capacitance Tolerance:	±10%; ±20%										
Rated Voltage (V _R)	≤ +85°C:	2.5	4	6.3	10	12	16	20	25	35	50
Category Voltage (V _C)	≤ +125°C:	1.7	2.7	4	7	8	10	13	17	23	33
Surge Voltage (V _S)	≤ +85°C:	3.3	5.2	8	13	16	20	26	32	46	65
Surge Voltage (V _S)	≤ +125°C:	2.2	3.4	5	8	10	13	16	20	28	40
Temperature Range:	-55°C to +125°C										
Reliability:	0.5% per 1000 hours at 85°C, V _R with 0.1Ω/V series impedance, 60% confidence level										
	Meets requirements of AEC-Q200										



TRM Professional Multianode

Tantalum Ultra Low ESR Capacitor



CAPACITANCE AND RATED VOLTAGE RANGE (LETTER DENOTES CASE SIZE)

Capacitance		Rated Voltage DC (V _R) to 85°C									
µF	Code	2.5V (e)	4V (G)	6.3V (J)	10V (A)	12V (B)	16V (C)	20V (D)	25V (E)	35V (V)	50V (T)
4.7	475										D(200)
6.8	685										
10	106									D(120)	
15	156										
22	226									D(70) E(60,100)	
33	336								D(65)	E(50,65)	
47	476						D(100)	D(55)	E(65)		
68	686										
100	107							E(35,45)			
150	157				D(45)		E(30,40)				
220	227				D(35)	E(35)	U(30,40)				
330	337		D(35)	D(35)	E(35)						
470	477		D(35)	E(30)	U(23,30)						
680	687		E(23)	U(18,23)							
1000	108	D(25)	E(23) U(18,23)								
1500	158	E(18) U(18,23)									

Released ratings, (ESR ratings in mOhms in parentheses)

Note: Voltage ratings are minimum values. AVX reserves the right to supply higher voltage ratings in the same case size, to the same reliability standards.

TRM Professional Multianode Tantalum Ultra Low ESR Capacitor



RATINGS & PART NUMBER REFERENCE

AVX Part No.	Case Size	Capacitance (µF)	Rated Voltage (V)	Rated Temperature (°C)	Category Voltage (V)	Category Temperature (°C)	DCL Max. (µA)	DF Max. (%)	ESR Max. @ 100kHz (mΩ)	100kHz RMS Current (A)			MSL
										25°C	85°C	125°C	
2.5 Volt @ 85°C													
TRMD108*002#0025	D	1000	2.5	85	1.7	125	18.8	8	25	3.194	2.874	1.277	3
TRME158*002#0018	E	1500	2.5	85	1.7	125	28.1	6	18	3.873	3.486	1.549	3
TRMU158*002R0018	U	1500	2.5	85	1.7	125	22.5	6	18	4.048	3.643	1.619	3
TRMU158*002R0023	U	1500	2.5	85	1.7	125	22.5	6	23	3.581	3.223	1.433	3
4 Volt @ 85°C													
TRMD337*004#0035	D	330	4	85	2.7	125	9.9	8	35	2.699	2.429	1.080	3
TRMD477*004#0035	D	470	4	85	2.7	125	14.1	8	35	2.699	2.429	1.080	3
TRME687*004#0023	E	680	4	85	2.7	125	20.4	6	23	3.426	3.084	1.370	3
TRME108*004#0023	E	1000	4	85	2.7	125	30	6	23	3.426	3.084	1.370	3
TRMU108*004R0018	U	1000	4	85	2.7	125	30	6	18	4.048	3.643	1.619	3
TRMU108*004R0023	U	1000	4	85	2.7	125	30	6	23	3.581	3.223	1.433	3
6.3 Volt @ 85°C													
TRMD337*006#0035	D	330	6.3	85	4	125	14.9	8	35	2.699	2.429	1.080	3
TRME477*006#0030	E	470	6.3	85	4	125	21.2	6	30	3.000	2.700	1.200	3
TRMU687*006R0018	U	680	6.3	85	4	125	30.6	6	18	4.048	3.643	1.619	3
TRMU687*006R0023	U	680	6.3	85	4	125	30.6	6	23	3.581	3.223	1.433	3
10 Volt @ 85°C													
TRMD157*010#0045	D	150	10	85	7	125	11.3	8	45	2.380	2.142	0.952	3
TRMD227*010#0035	D	220	10	85	7	125	16.5	8	35	2.699	2.429	1.080	3
TRME337*010#0035	E	330	10	85	7	125	24.8	6	35	2.777	2.500	1.111	3
TRMU477*010R0023	U	470	10	85	7	125	35.3	8	23	3.581	3.223	1.433	3
TRMU477*010R0030	U	470	10	85	7	125	35.3	8	30	3.136	2.822	1.254	3
12 Volt @ 85°C													
TRME227*012#0035	E	220	12	85	8.4	125	19.8	6	35	2.777	2.500	1.111	3
16 Volt @ 85°C													
TRMD476*016#0100	D	47	16	85	10	125	5.6	8	100	1.597	1.437	0.639	3
TRME157*016#0030	E	150	16	85	10	125	18	6	30	3.000	2.700	1.200	3
TRME157*016#0040	E	150	16	85	10	125	18	6	40	2.598	2.338	1.039	3
TRMU227*016R0030	U	220	16	85	10	125	26.4	8	30	3.136	2.822	1.254	3
TRMU227*016R0040	U	220	16	85	10	125	26.4	8	40	2.716	2.444	1.086	3
20 Volt @ 85°C													
TRMD476*020#0055	D	47	20	85	13	125	7.1	8	55	2.153	1.938	0.861	3
TRME107*020#0035	E	100	20	85	13	125	15	6	35	2.777	2.500	1.111	3
TRME107*020#0045	E	100	20	85	13	125	15	6	45	2.449	2.205	0.980	3
25 Volt @ 85°C													
TRMD336*025#0065	D	33	25	85	17	125	6.2	8	65	1.981	1.783	0.792	3
TRME476*025#0065	E	47	25	85	17	125	8.8	6	65	2.038	1.834	0.815	3
35 Volt @ 85°C													
TRMD106*035#0120	D	10	35	85	23	125	2.6	8	120	1.458	1.312	0.583	3
TRMD226*035#0070	D	22	35	85	23	125	5.8	8	70	1.909	1.718	0.763	3
TRME226*035#0060	E	22	35	85	23	125	5.8	6	60	2.121	1.909	0.849	3
TRME226*035#0100	E	22	35	85	23	125	5.8	6	100	1.643	1.479	0.657	3
TRME336*035#0050	E	33	35	85	23	125	8.7	6	50	2.324	2.091	0.930	3
TRME336*035#0065	E	33	35	85	23	125	8.7	6	65	2.038	1.834	0.815	3
50 Volt @ 85°C													
TRMD475*050#0200	D	4.7	50	85	33	125	1.8	8	200	1.129	1.016	0.452	3

Moisture Sensitivity Level (MSL) is defined according to J-STD-020.

All technical data relates to an ambient temperature of +25°C. Capacitance and DF are measured at 120Hz, 0.5V RMS with a maximum DC bias of 2.2 volts.

DCL is measured at rated voltage after 5 minutes.

The EIA & CECC standards for low ESR Solid Tantalum Capacitors allow an ESR movement to 1.25 times catalogue limit post mounting.

For typical weight and composition see page 274.

NOTE: AVX reserves the right to supply higher voltage ratings or tighter tolerance part in the same case size, to the same reliability standards.

TRM Professional Multianode

Tantalum Ultra Low ESR Capacitor

QUALIFICATION TABLE

TEST	TRM professional multianode series (Temperature range -55°C to +125°C)									
	Condition			Characteristics						
Endurance	Apply rated voltage (Ur) at 85°C and / or category voltage (Uc) at 125°C for 2000 hours through a circuit impedance of $\leq 0.1\Omega/V$. Stabilize at room temperature for 1-2 hours before measuring.			Visual examination	no visible damage					
				DCL	initial limit					
				$\Delta C/C$	within $\pm 10\%$ of initial value					
				DF	initial limit					
				ESR	1.25 x initial limit					
Storage Life	Store at 125°C, no voltage applied, for 2000 hours. Stabilize at room temperature for 1-2 hours before measuring.			Visual examination	no visible damage					
				DCL	1.25 x initial limit					
				$\Delta C/C$	within $\pm 10\%$ of initial value					
				DF	initial limit					
				ESR	1.25 x initial limit					
Humidity	Store at 65°C and 95% relative humidity for 500 hours, with no applied voltage. Stabilize at room temperature and humidity for 1-2 hours before measuring.			Visual examination	no visible damage					
				DCL	1.5 x initial limit					
				$\Delta C/C$	within $\pm 10\%$ of initial value					
				DF	1.2 x initial limit					
				ESR	1.25 x initial limit					
Biased Humidity	Apply rated voltage (Ur) at 85°C, 85% relative humidity for 1000 hours. Stabilize at room temperature and humidity for 1-2 hours before measuring.			Visual examination	no visible damage					
				DCL	2 x initial limit					
				$\Delta C/C$	within $\pm 10\%$ of initial value					
				DF	1.2 x initial limit					
				ESR	1.25 x initial limit					
Temperature Stability	Step	Temperature°C	Duration(min)		+20°C	-55°C	+20°C	+85°C	+125°C	+20°C
	1	+20	15							
	2	-55	15	DCL	IL*	n/a	IL*	10 x IL*	12.5 x IL*	IL*
	3	+20	15	$\Delta C/C$	n/a	+0/-10%	$\pm 5\%$	+10/-0%	+12/-0%	$\pm 5\%$
	4	+85	15	DF	IL*	1.5 x IL*	IL*	1.5 x IL*	2 x IL*	IL*
	5	+125	15							
	6	+20	15	ESR	1.25xIL*	2.5xIL*	1.25xIL*	1.25xIL*	1.25xIL*	1.25xIL*
Surge Voltage	Apply 1.3x category voltage (Uc) at 125°C for 1000 cycles of duration 6 min (30 sec charge, 5 min 30 sec discharge) through a charge / discharge resistance of 1000 Ω			Visual examination	no visible damage					
				DCL	initial limit					
				$\Delta C/C$	within $\pm 5\%$ of initial value					
				DF	initial limit					
				ESR	1.25 x initial limit					
Mechanical Shock	MIL-STD-202, Method 213, Condition F			Visual examination	no visible damage					
				DCL	initial limit					
				$\Delta C/C$	within $\pm 5\%$ of initial value					
				DF	initial limit					
				ESR	1.25 x initial limit					
Vibration	MIL-STD-202, Method 204, Condition D			Visual examination	no visible damage					
				DCL	initial limit					
				$\Delta C/C$	within $\pm 5\%$ of initial value					
				DF	initial limit					
				ESR	1.25 x initial limit					

*Initial Limit

TRM Professional Multianode Tantalum Ultra Low ESR Capacitor

AVX SOLID ELECTROLYTIC CAPACITOR ROADMAP

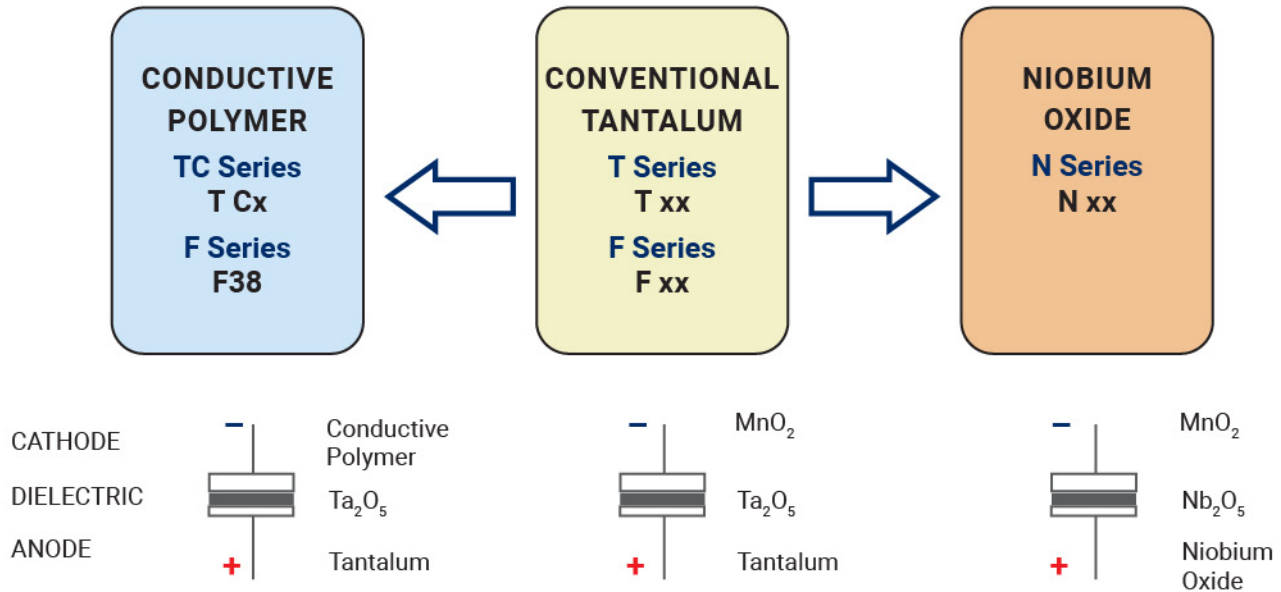

FIVE CAPACITOR CONSTRUCTION STYLES

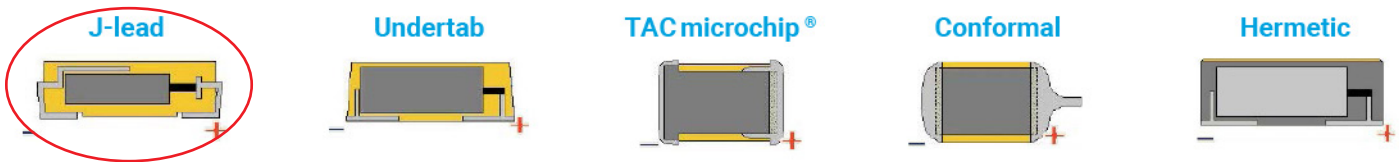

SERIES LINE UP : CONVENTIONAL SMD MnO₂

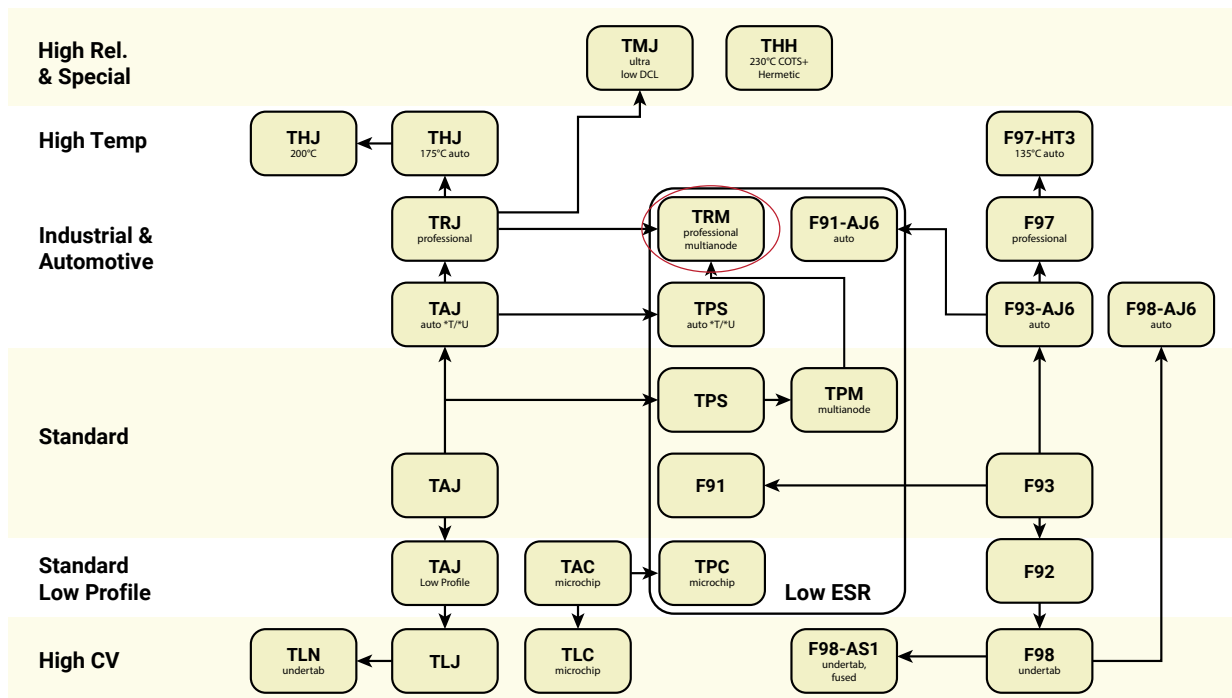

TMJ Tantalum

SMD S1gma™ Series Capacitors



The AVX S1gma™ series is offering a next generation of statistical screening and process control enhancement of tantalum capacitors for professional applications with improved reliability and extremely low DCL needs.



FEATURES

- 55 to +125°C Operation Temperature
- Basic Reliability Better than 0.5%/1000 hours
- 100% Surge Current Tested
- (2x Improvement Over Commercial Series)
- Improved DCL Limits 0.001CV* and 0.005CV

S1gma™ Prime – Utilizes 3 S1gma™ electrical screening to remove possible maverick parts from the distribution.

S1gma™ Premium – S1gma™ Prime, with addition of capability statistical screening utilizing the AVX patented Q-Process to effectively remove components that may experience excessive parametric shifts or instability in operational life.

S1gma™ Pro Custom – A custom option where specific parameter limits and screening methods can be agreed based on 3 S1gma™ and Q-Process statistical screening based on capability techniques.

*selected codes, 0.001CV limit is available with S1gma™ Premium and Pro Custom options only



TMJ CONSTRUCTION

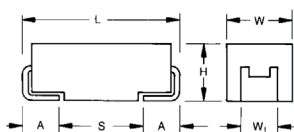

APPLICATIONS

- Wireless Battery Operated Sensors
- TPM
- Automotive
- Avionics
- Safety Systems
- Energy Harvesting

For additional information on Q-process please consult the AVX technical publication "Reaching the Highest Reliability for Tantalum Capacitors"

(see the link: <http://www.avx.com/docs/techinfo/Qprocess.pdf>)

MARKING

A, B, C, D, E, U CASE

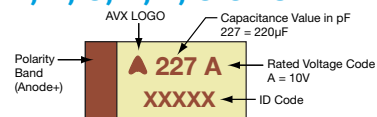

CASE DIMENSIONS:

millimeters (inches)

Code	EIA Code	EIA Metric	L±0.20 (0.008)	W+0.20 (0.008) -0.10 (0.004)	H+0.20 (0.008) -0.10 (0.004)	W _t ±0.20 (0.008)	A+0.30 (0.012) -0.20 (0.008)	S Min.
A	1206	3216-18	3.20 (0.126)	1.60 (0.063)	1.60 (0.063)	1.20 (0.047)	0.80 (0.031)	1.10 (0.043)
B	1210	3528-21	3.50 (0.138)	2.80 (0.110)	1.90 (0.075)	2.20 (0.087)	0.80 (0.031)	1.40 (0.055)
C	2312	6032-28	6.00 (0.236)	3.20 (0.126)	2.60 (0.102)	2.20 (0.087)	1.30 (0.051)	2.90 (0.114)
D	2917	7343-31	7.30 (0.287)	4.30 (0.169)	2.90 (0.114)	2.40 (0.094)	1.30 (0.051)	4.40 (0.173)
E	2917	7343-43	7.30 (0.287)	4.30 (0.169)	4.10 (0.162)	2.40 (0.094)	1.30 (0.051)	4.40 (0.173)
U	2924	7361-43	7.30 (0.287)	6.10 (0.240)	4.10 (0.162)	3.10 (0.122)	1.30 (0.051)	4.40 (0.173)

W_t, dimension applies to the termination width for A dimensional area only.

HOW TO ORDER

TMJ	D	227	K	006	#	C	^	A
Type	Case Size See table above	Capacitance Code pF code: 1st two digits represent significant figures, 3rd digit represents multiplier (number of zeros to follow)	Tolerance K = ±10%	Rated DC Voltage 006 = 6.3Vdc 010 = 10Vdc 016 = 16Vdc 020 = 20Vdc 025 = 25Vdc 035 = 35Vdc 050 = 50Vdc	Packaging R = Pure Tin 7" Reel H = Tin Lead 7" Reel (Contact Manufacturer) Non RoHS	ESR Range C = Standard L = Low ESR	Suffix QX = S1gma™ Prime QY = S1gma™ Premium xx = S1gma™ Pro Custom	DCL A = 0.001CV C = 0.005CV

TECHNICAL SPECIFICATIONS

Technical Data:	All technical data relate to an ambient temperature of +25°C								
Capacitance Range:	0.22 µF to 680 µF								
Capacitance Tolerance:	±10%								
Leakage Current DCL:	(A) 0.001CV, (C) 0.005CV								
Rated Voltage (V _R)	≤ +85°C:	6.3	10	16	20	25	35	50	
Category Voltage (V _C)	≤ +125°C:	4	7	10	13	17	23	33	
Surge Voltage (V _S)	≤ +85°C:	8	13	20	26	32	46	65	
Surge Voltage (V _S)	≤ +125°C:	5	8	13	16	20	28	40	
Temperature Range:	-55°C to +125°C								
Reliability:	0.5% per 1000 hours at 85°C, V _R with 0.1Ω/V series impedance, 60% confidence level AEC-Q200 per request								



The Important Information/Disclaimer is incorporated in the catalog where these specifications came from or available online at www.avx.com/disclaimer/ by reference and should be reviewed in full before placing any order.

CAPACITANCE AND RATED VOLTAGE RANGE (LETTER DENOTES CASE SIZE)

Capacitance		Rated voltage (V _R) to 85°C (Voltage Code)						
µF	Code	6.3V (J)	10V (A)	16V (C)	20V (D)	25V (E)	35V (V)	50V (T)
0.22	224							A
0.33	334						A	A
0.47	474						A	B
0.68	684						A	B
1.0	105					A	B	C
1.5	155				A	A	B	C
2.2	225			A	A	B	B	C
3.3	335			A	A	B	B	C
4.7	475		A	A	B	B	C	D
6.8	685		A	B	B	C	C	D
10	106	A	A	B	C	C	C	E
15	156	A	B	B	C	C	D	U
22	226	B	B	C	C	D	D	U
33	336	B	C	C	D	D	E	
47	476	C	C	D	D	D	U	
68	686	C	C	D	E	U		
100	107	C	D	E	E	U		
150	157	D	D	E	U			
220	227	D	E	U				
330	337	E	E					
470	477	E	U					
680	687	U						

Released ratings

Note: Voltage ratings are minimum values. AVX reserves the right to supply higher voltage ratings in the same case size, to the same reliability standards.

LEAKAGE CURRENT vs. RATED VOLTAGE

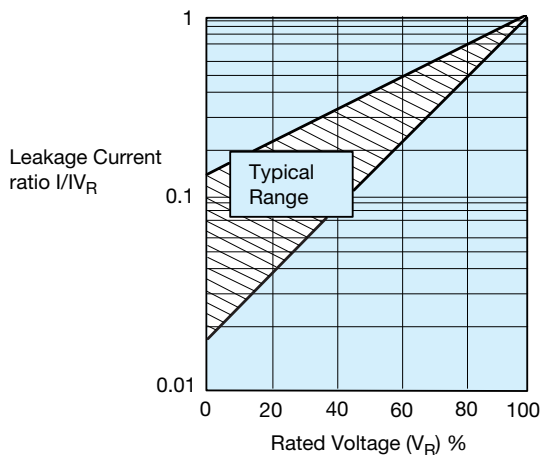

RATINGS & PART NUMBER REFERENCE

AVX Part No.	Case Size	Capacitance (µF)	Rated Voltage (V)	Rated Temperature (°C)	Category Voltage (V)	Category Temperature (°C)	DCL Max. (µA)	DF Max. (%)	ESR Max. @ 100kHz (mΩ)	100kHz RMS Current (mA)			MSL
										25°C	85°C	125°C	
6.3 Volt @ 85°C													
TMJA106K006#CQYA	A	10	6.3	85	4	125	0.1	6	1500	224	201	89	3
TMJA106K006#C°C	A	10	6.3	85	4	125	0.3	6	1500	224	201	89	3
TMJA156K006#CQYA	A	15	6.3	85	4	125	0.1	6	1500	224	201	89	3
TMJA156K006#C°C	A	15	6.3	85	4	125	0.45	6	1500	224	201	89	3
TMJB226K006#C°C	B	22	6.3	85	4	125	0.66	6	600	376	339	151	3
TMJB336K006#C°C	B	33	6.3	85	4	125	0.99	6	600	376	339	151	3
TMJC476K006#CQYA	C	47	6.3	85	4	125	0.28	6	300	606	545	242	3
TMJC476K006#C°C	C	47	6.3	85	4	125	1.41	6	300	606	545	242	3
TMJC686K006#CQYA	C	68	6.3	85	4	125	0.41	6	300	606	545	242	3
TMJC686K006#C°C	C	68	6.3	85	4	125	2.04	6	300	606	545	242	3
TMJC107K006#CQYA	C	100	6.3	85	4	125	0.60	6	300	606	545	242	3
TMJC107K006#C°C	C	100	6.3	85	4	125	3	6	300	606	545	242	3
TMJD157K006#CQYA	D	150	6.3	85	4	125	0.90	6	200	866	779	346	3
TMJD157K006#C°C	D	150	6.3	85	4	125	4.5	6	200	866	779	346	3
TMJD227K006#CQYA	D	220	6.3	85	4	125	1.32	8	200	866	779	346	3
TMJD227K006#C°C	D	220	6.3	85	4	125	6.6	8	200	866	779	346	3
TMJE337K006#C°C	E	330	6.3	85	4	125	9.9	8	200	908	817	363	3
TMJE477K006#CQYA	E	470	6.3	85	4	125	2.82	8	200	908	817	363	3
TMJE477K006#C°C	E	470	6.3	85	4	125	14.1	8	200	908	817	363	3
TMJU687K006#C°C	U	680	6.3	85	4	125	20.4	12	250	812	731	325	3
10 Volt @ 85°C													
TMJA475K010#CQXC	A	4.7	10	85	7	125	0.24	6	2000	194	174	77	3
TMJA685K010#CQYA	A	6.8	10	85	7	125	0.1	6	2000	194	174	77	3
TMJA685K010#C°C	A	6.8	10	85	7	125	0.34	6	2000	194	174	77	3
TMJA106K010#CQYA	A	10	10	85	7	125	0.10	6	2000	194	174	77	3
TMJA106K010#C°C	A	10	10	85	7	125	0.5	6	2000	194	174	77	3
TMJB156K010#C°C	B	15	10	85	7	125	0.75	6	700	348	314	139	3
TMJB226K010#C°C	B	22	10	85	7	125	1.1	6	700	348	314	139	3
TMJC336K010#C°C	C	33	10	85	7	125	1.65	6	300	606	545	242	3
TMJC476K010#C°C	C	47	10	85	7	125	2.35	6	300	606	545	242	3
TMJC686K010#C°C	C	68	10	85	7	125	3.4	6	300	606	545	242	3
TMJD107K010#C°C	D	100	10	85	7	125	5.00	6	150	1000	900	400	3
TMJD157K010#C°C	D	150	10	85	7	125	7.50	8	150	1000	900	400	3
TMJE227K010#C°C	E	220	10	85	7	125	11	8	150	1049	944	420	3
TMJE337K010#CQYA	E	330	10	85	7	125	3.3	8	150	1049	944	420	3
TMJE337K010#C°C	E	330	10	85	7	125	16.5	8	150	1049	944	420	3
TMJU477K010#C°C	U	470	10	85	7	125	23.5	12	200	908	817	363	3
16 Volt @ 85°C													
TMJA225K016#CQXC	A	2.2	16	85	10	125	0.18	6	3500	146	132	59	3
TMJA335K016#CQXC	A	3.3	16	85	10	125	0.26	6	3500	146	132	59	3
TMJA475K016#C°C	A	4.7	16	85	10	125	0.38	6	3500	146	132	59	3
TMJB685K016#C°C	B	6.8	16	85	10	125	0.54	6	1200	266	240	106	3
TMJB106K016#C°C	B	10	16	85	10	125	0.80	6	1200	266	240	106	3
TMJB156K016#C°C	B	15	16	85	10	125	1.20	6	1200	266	240	106	3
TMJC226K016#C°C	C	22	16	85	10	125	1.76	6	350	561	505	224	3
TMJC336K016#C°C	C	33	16	85	10	125	2.64	6	350	561	505	224	3
TMJD476K016#C°C	D	47	16	85	10	125	3.76	6	200	866	779	346	3
TMJD686K016#C°C	D	68	16	85	10	125	5.44	6	200	866	779	346	3
TMJE107K016#C°C	E	100	16	85	10	125	8.00	6	150	1049	944	420	3
TMJE157K016#C°C	E	150	16	85	10	125	12	6	150	1049	944	420	3
TMJU227K016#C°C	U	220	16	85	10	125	17.6	1	200	908	817	363	3
20 Volt @ 85°C													
TMJA155K020#CQXC	A	1.5	20	85	13	125	0.15	6	3000	158	142	63	3
TMJA225K020#CQXC	A	2.2	20	85	13	125	0.22	6	3000	158	142	63	3
TMJA335K020#C°C	A	3.3	20	85	13	125	0.33	6	3000	158	142	63	3
TMJB475K020#C°C	B	4.7	20	85	13	125	0.47	6	1000	292	262	117	3
TMJB685K020#C°C	B	6.8	20	85	13	125	0.68	6	1000	292	262	117	3
TMJC106K020#C°C	C	10	20	85	13	125	1	6	500	469	422	188	3
TMJC156K020#C°C	C	15	20	85	13	125	1.5	6	500	469	422	188	3
TMJC226K020#C°C	C	22	20	85	13	125	2.2	6	500	469	422	188	3
TMJD336K020#C°C	D	33	20	85	13	125	3.3	6	250	775	697	310	3
TMJD476K020#C°C	D	47	20	85	13	125	4.70	6	250	775	697	310	3
TMJE686K020#C°C	E	68	20	85	13	125	6.8	6	200	908	817	363	3
TMJE107K020#C°C	E	100	20	85	13	125	10	6	200	908	817	363	3
TMJU157K020#CQXC	U	150	20	85	13	125	15	12	250	812	731	325	3
25 Volt @ 85°C													
TMJA105K025#CQXC	A	1	25	85	17	125	0.13	4	3000	158	142	63	3
TMJA155K025#CQXC	A	1.5	25	85	17	125	0.19	6	3000	158	142	63	3
TMJB225K025#C°C	B	2.2	25	85	17	125	0.28	6	2000	206	186	82	3
TMJB335K025#C°C	B	3.3	25	85	17	125	0.41	6	2000	206	186	82	3

RATINGS & PART NUMBER REFERENCE

AVX Part No.	Case Size	Capacitance (µF)	Rated Voltage (V)	Rated Temperature (°C)	Category Voltage (V)	Category Temperature (°C)	DCL Max. (µA)	DF Max. (%)	ESR Max. @ 100kHz (mΩ)	100kHz RMS Current (mA)			MSL
										25°C	85°C	125°C	
TMJB475K025#C* ^C	B	4.7	25	85	17	125	0.59	6	2000	206	186	82	3
TMJC685K025#C* ^C	C	6.8	25	85	17	125	0.85	6	600	428	385	171	3
TMJC106K025#C* ^C	C	10	25	85	17	125	1.25	6	600	428	385	171	3
TMJC156K025#C* ^C	C	15	25	85	17	125	1.88	6	600	428	385	171	3
TMJD226K025#CQYA	D	22	25	85	17	125	0.55	6	400	612	551	245	3
TMJD226K025#C* ^C	D	22	25	85	17	125	2.75	6	400	612	551	245	3
TMJD336K025#CQYA	D	33	25	85	17	125	0.82	6	400	612	551	245	3
TMJD336K025#C* ^C	D	33	25	85	17	125	4.13	6	400	612	551	245	3
TMJD476K025#C* ^C	D	47	25	85	17	125	5.88	6	400	612	551	245	3
TMJU686K025#CQXC	U	68	25	85	17	125	8.5	12	450	606	545	242	3
TMJU107K025#CQXC	U	100	25	85	17	125	12.5	12	450	606	545	242	3
35 Volt @ 85°C													
TMJA334K035#CQXC	A	0.33	35	85	23	125	0.1	4	6000	112	101	45	3
TMJA474K035#CQXC	A	0.47	35	85	23	125	0.1	4	6000	112	101	45	3
TMJA684K035#CQXC	A	0.68	35	85	23	125	0.12	4	6000	112	101	45	3
TMJB105K035#CQXC	B	1	35	85	23	125	0.18	4	2500	184	166	74	3
TMJB155K035#C* ^C	B	1.5	35	85	23	125	0.26	6	2500	184	166	74	3
TMJB225K035#C* ^C	B	2.2	35	85	23	125	0.39	6	2500	184	166	74	3
TMJB335K035#C* ^C	B	3.3	35	85	23	125	0.58	6	2500	184	166	74	3
TMJC475K035#CQYA	C	4.7	35	85	23	125	0.16	6	600	428	385	171	3
TMJC475K035#C* ^C	C	4.7	35	85	23	125	0.82	6	600	428	385	171	3
TMJC685K035#C* ^C	C	6.8	35	85	23	125	1.19	6	600	428	385	171	3
TMJC106K035#C* ^C	C	10	35	85	23	125	1.75	6	600	428	385	171	3
TMJD156K035#CQYA	D	15	35	85	23	125	0.52	6	400	612	551	245	3
TMJD156K035#C* ^C	D	15	35	85	23	125	2.63	6	400	612	551	245	3
TMJD226K035#CQYA	D	22	35	85	23	125	0.77	6	400	612	551	245	3
TMJD226K035#C* ^C	D	22	35	85	23	125	3.85	6	400	612	551	245	3
TMJE336K035#CQYA	E	33	35	85	23	125	1.15	6	250	812	731	325	3
TMJE336K035#C* ^C	E	33	35	85	23	125	5.78	6	250	812	731	325	3
TMJU476K035#CQXC	U	47	35	85	23	125	8.23	12	300	742	667	297	3
TMJU476K035#CQYA	U	47	35	85	23	125	1.64	12	300	742	667	297	3
50 Volt @ 85°C													
TMJA224K050#CQXC	A	0.22	50	85	33	125	0.1	4	7000	104	93	41	3
TMJA334K050#CQXC	A	0.33	50	85	33	125	0.1	4	7000	104	93	41	3
TMJB474K050#CQXC	B	0.47	50	85	33	125	0.12	4	2000	206	186	82	3
TMJB684K050#CQXC	B	0.68	50	85	33	125	0.17	4	2000	206	186	82	3
TMJC105K050#C* ^C	C	1	50	85	33	125	0.25	4	1500	271	244	108	3
TMJC155K050#C* ^C	C	1.5	50	85	33	125	0.38	6	1500	271	244	108	3
TMJC225K050#CQYA	C	2.2	50	85	33	125	0.11	6	1500	271	244	108	3
TMJC225K050#C* ^C	C	2.2	50	85	33	125	0.55	6	1500	271	244	108	3
TMJC335K050#CQYA	C	3.3	50	85	33	125	0.17	6	1500	271	244	108	3
TMJC335K050#C* ^C	C	3.3	50	85	33	125	0.83	6	1500	271	244	108	3
TMJD475K050#C* ^C	D	4.7	50	85	33	125	1.18	4.5	600	500	450	200	3
TMJD685K050#C* ^C	D	6.8	50	85	33	125	1.7	4.5	600	500	450	200	3
TMJE106K050#CQYA	E	10	50	85	33	125	0.5	4.5	400	642	578	257	3
TMJE106K050#C* ^C	E	10	50	85	33	125	2.5	4.5	400	642	578	257	3
TMJU156K050#CQXC	U	15	50	85	33	125	3.75	12	450	606	545	242	3
TMJU226K050#CQXC	U	22	50	85	33	125	5.5	12	450	606	545	242	3

Moisture Sensitivity Level (MSL) is defined according to J-STD-020.

All technical data relates to an ambient temperature of +25°C. Capacitance and DF are measured at 120Hz, 0.5V RMS with a maximum DC bias of 2.2 volts.

DCL is measured at rated voltage after 5 minutes.

The EIA & CECC standards for low ESR Solid Tantalum Capacitors allow an ESR movement to 1.25 times catalogue limit post mounting.

NOTE: AVX reserves the right to supply higher voltage ratings or tighter tolerance part in the same case size, to the same reliability standards.

QUALIFICATION TABLE

TEST	TMJ S1gma™ series (Temperature range -55°C to +125°C)										
	Condition			Characteristics							
Endurance	Apply rated voltage (Ur) at 85°C and / or category voltage (Uc) at 125°C for 2000 hours through a circuit impedance of $\leq 0.1\Omega/V$. Stabilize at room temperature for 1-2 hours before measuring.			Visual examination	no visible damage						
				DCL	2 x initial limit						
				$\Delta C/C$	within $\pm 10\%$ of initial value						
				DF	initial limit						
				ESR	1.25 x initial limit						
Storage Life	Store at 125°C, no voltage applied, for 2000 hours. Stabilize at room temperature for 1-2 hours before measuring.			Visual examination	no visible damage						
				DCL	2 x initial limit						
				$\Delta C/C$	within $\pm 10\%$ of initial value						
				DF	initial limit						
				ESR	1.25 x initial limit						
Humidity	Store at 65°C and 90 - 95% relative humidity for 500 hours, with no applied voltage. Stabilize at room temperature and humidity for 1-2 hours before measuring.			Visual examination	no visible damage						
				DCL	3 x initial limit						
				$\Delta C/C$	within $\pm 10\%$ of initial value						
				DF	1.2 x initial limit						
				ESR	1.25 x initial limit						
Biased Humidity	Apply rated voltage (Ur) at 85°C, 85% relative humidity for 1000 hours. Stabilize at room temperature and humidity for 1-2 hours before measuring.			Visual examination	no visible damage						
				DCL	3 x initial limit						
				$\Delta C/C$	within $\pm 10\%$ of initial value						
				DF	1.2 x initial limit						
				ESR	1.25 x initial limit						
Temperature Stability	Step	Temperature°C	Duration(min)		+20°C	-55°C	+20°C	+85°C	+125°C	+20°C	
	1	+20	15								
	2	-55	15	DCL	IL*	n/a	IL*	10 x IL*	15 x IL*	1.5 x IL*	
	3	+20	15	$\Delta C/C$	n/a	+0/-10%	$\pm 5\%$	+10/-0%	+15/-0%	$\pm 5\%$	
	4	+85	15	DF	IL*	1.5 x IL*	IL*	1.5 x IL*	2 x IL*	IL*	
	5	+125	15								
	6	+20	15	ESR	1.25xIL*	2.5xIL*	1.25xIL*	1.25xIL*	1.25xIL*	1.25xIL*	
Surge Voltage	Apply 1.3x category voltage (Uc) at 125°C for 1000 cycles of duration 6 min (30 sec charge, 5 min 30 sec discharge) through a charge / discharge resistance of 1000 Ω			Visual examination	no visible damage						
				DCL	2 x initial limit						
				$\Delta C/C$	within $\pm 5\%$ of initial value						
				DF	initial limit						
				ESR	1.25 x initial limit						
Mechanical Shock	MIL-STD-202, Method 213, Condition C			Visual examination	no visible damage						
				DCL	initial limit						
				$\Delta C/C$	within $\pm 5\%$ of initial value						
				DF	initial limit						
				ESR	initial limit						
Vibration	MIL-STD-202, Method 204, Condition D			Visual examination	no visible damage						
				DCL	initial limit						
				$\Delta C/C$	within $\pm 5\%$ of initial value						
				DF	initial limit						
				ESR	initial limit						

*Initial Limit

AVX SOLID ELECTROLYTIC CAPACITOR ROADMAP

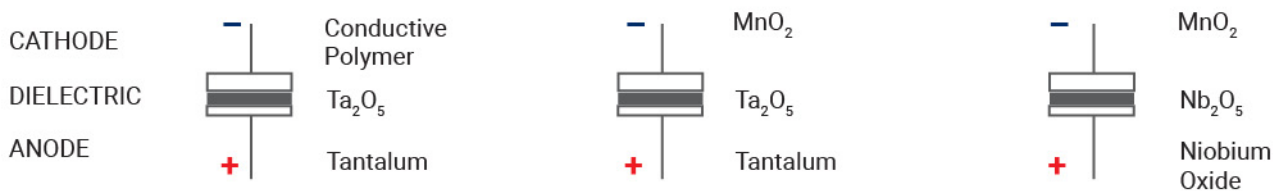
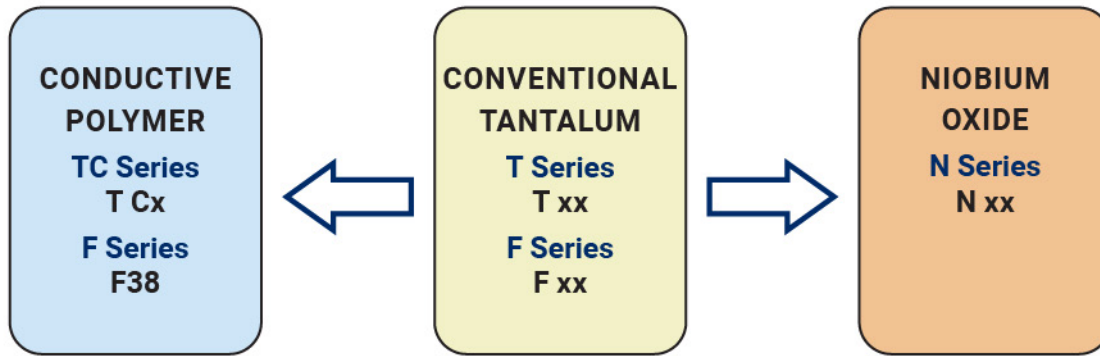

FIVE CAPACITOR CONSTRUCTION STYLES

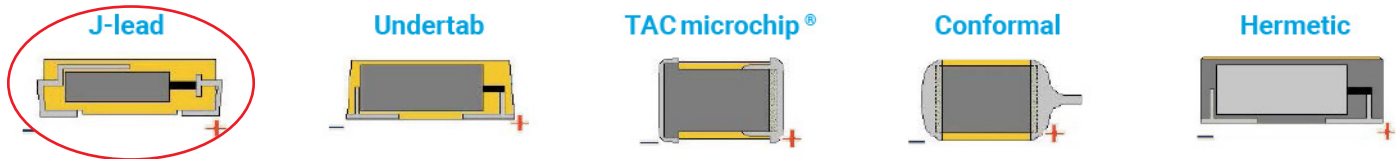

SERIES LINE UP : CONVENTIONAL SMD MnO₂

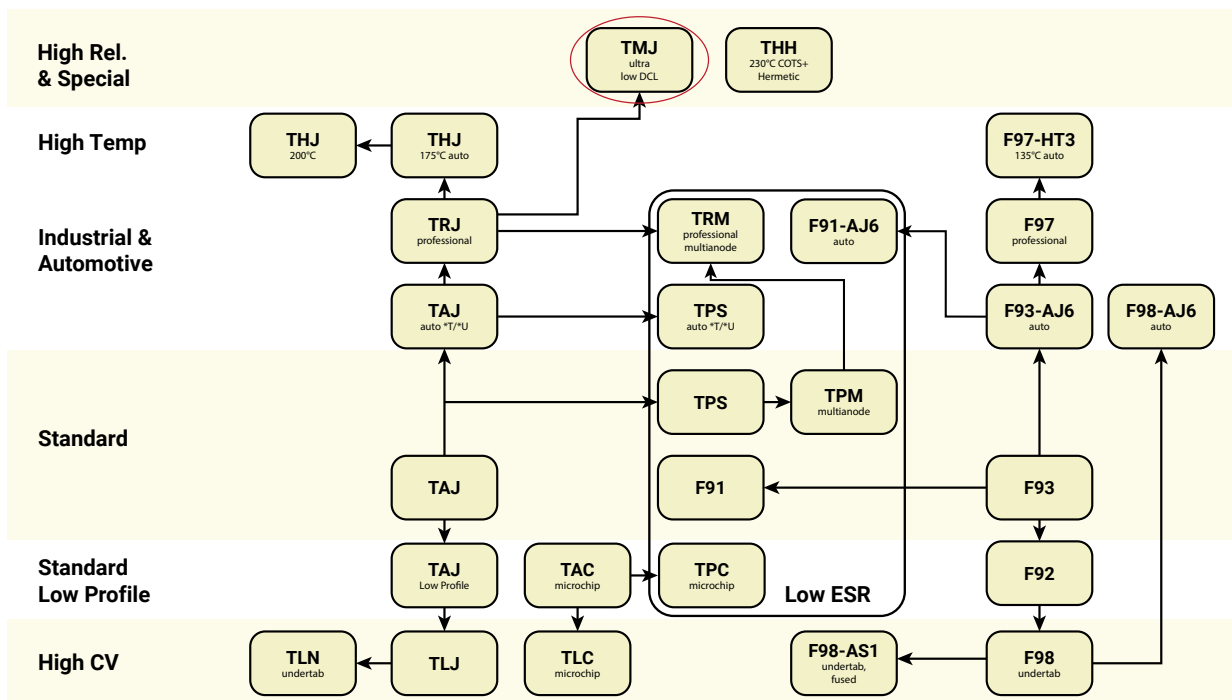

THJ Series

High Temperature Tantalum Chip Capacitor

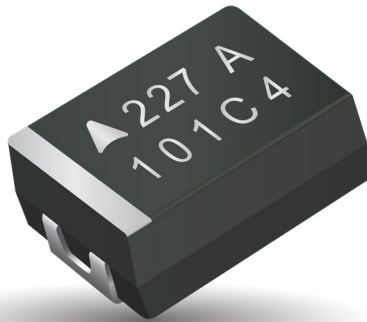

FEATURES

- Improved Reliability – 2x Standard
- 175°C @ 0.5V_R Continuous Operation
- 100% Surge Current Tested
- CV Range: 0.10-220µF / 6.3-50V
- 5 Case Sizes Available
- Low ESR options on approval
- High Temperature Automotive and Industry Applications



SnPb termination option is not RoHS compliant.

APPLICATIONS

- Automotive ECU and ABS Control Electronics
- Geothermal Instrumentation

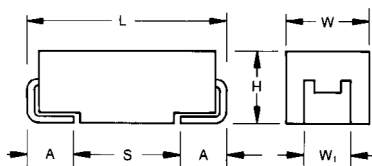

CASE DIMENSIONS:

millimeters (inches)

Code	EIA Code	EIA Metric	L±0.20 (0.008)	W+0.20 (0.008) -0.10 (0.004)	H+0.20 (0.008) -0.10 (0.004)	W ₁ ±0.20 (0.008)	A+0.30 (0.012) -0.20 (0.008)	S Min.
A	1206	3216-18	3.20 (0.126)	1.60 (0.063)	1.60 (0.063)	1.20 (0.047)	0.80 (0.031)	1.10 (0.043)
B	1210	3528-21	3.50 (0.138)	2.80 (0.110)	1.90 (0.075)	2.20 (0.087)	0.80 (0.031)	1.40 (0.055)
C	2312	6032-28	6.00 (0.236)	3.20 (0.126)	2.60 (0.102)	2.20 (0.087)	1.30 (0.051)	2.90 (0.114)
D	2917	7343-31	7.30 (0.287)	4.30 (0.169)	2.90 (0.114)	2.40 (0.094)	1.30 (0.051)	4.40 (0.173)
E	2917	7343-43	7.30 (0.287)	4.30 (0.169)	4.10 (0.162)	2.40 (0.094)	1.30 (0.051)	4.40 (0.173)

W₁ dimension applies to the termination width for A dimensional area only.

MARKING A, B, C, D, E CASE

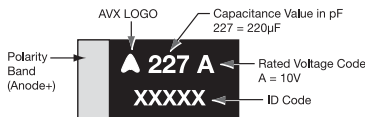

HOW TO ORDER

THJ	B	105	*	035	R	JN	-
Type	Case Size See table above	Capacitance Code pF code: 1st two digits represent significant figures 3rd digit represents multiplier (number of zeros to follow)	Tolerance K = ±10% M = ±20%	Rated DC Voltage 006=6.3Vdc 010=10Vdc 016=16Vdc 020=20Vdc 025=25Vdc 035=35Vdc 050=50Vdc	Packaging R = Pure Tin 7" Reel S = Pure Tin 13" Reel A = Gold Plating 7" Reel (Contact Manufacturer) B = Gold Plating 13" Reel (Contact Manufacturer) H = Tin Lead 7" Reel (Contact Manufacturer) K = Tin Lead 13" Reel (Contact Manufacturer) H, K = Non RoHS	Standard Suffix OR 0100 Low ESR in mΩ	Additional characters may be added for special requirements V = Dry pack Option

TECHNICAL SPECIFICATIONS

Technical Data:	All technical data relate to an ambient temperature of +25°C								
Capacitance Range:	0.10 µF to 220 µF								
Capacitance Tolerance:	±10%; ±20%								
Rated Voltage (V _R)	≤ +85°C:	6.3	10	16	20	25	35	50	
Category Voltage (V _C)	≤ +125°C:	4	7	10	13	17	23	33	
Category Voltage (V _C)	≤ +175°C:	3	5	8	10	12	17	25	
Surge Voltage (V _S)	≤ +85°C:	8	13	20	26	32	46	65	
Surge Voltage (V _S)	≤ +125°C:	5	8	13	16	20	28	40	
Surge Voltage (V _S)	≤ +175°C:	4	6	10	12	15	21	30	
Temperature Range:	-55°C to 175°C voltage derating.								
Reliability:	0.5% per 1000 hours at 85°C, V _R with 0.1Ω/V series impedance, 60% confidence level, 3.5 Fits at 40°C, 0.5V _R								
Termination Finish:	Sn Plating (standard), Gold and SnPb Plating upon request Meets requirements of AEC-Q200								



The Important Information/Disclaimer is incorporated in the catalog where these specifications came from or available online at www.avx.com/disclaimer/ by reference and should be reviewed in full before placing any order.

THJ Series

High Temperature Tantalum Chip Capacitor



CAPACITANCE AND RATED VOLTAGE RANGE (LETTER DENOTES CASE SIZE)

Capacitance		Rated voltage (V _R) to 85°C (Voltage Code)						
μF	Code	6.3V (J)	10V (A)	16V (C)	20V (D)	25V (E)	35V (V)	50V (T)
0.10	104						A	
0.15	154						A	
0.22	224						A	
0.33	334						A	
0.47	474					A	B	
0.68	684					A	B	
1.0	105					A	A/B	
1.5	155				A		C	
2.2	225			A/A(1500)		B/B(1500)	C	
3.3	335		A	A	B		C	D
4.7	475	A	A	A/B			C	D
6.8	685	A	A	A/B		C	D	D
10	106	A	A/B	B		C	D	D/E
15	156	B	B	B	C		D	
22	226	B	B	C/C(500)		D	D/D(300)	
33	336	B	C	C	D	D	E/E(150)	
47	476	C	C	C/D				
68	686	C	D	D				
100	107	D	D	E				
150	157	D						
220	227		E					

Released ratings, (ESR ratings in mOhms in parentheses)

Note: Voltage ratings are minimum values. AVX reserves the right to supply higher voltage ratings in the same case size, to the same reliability standards.

THJ 175°C Voltage vs Temperature Rating

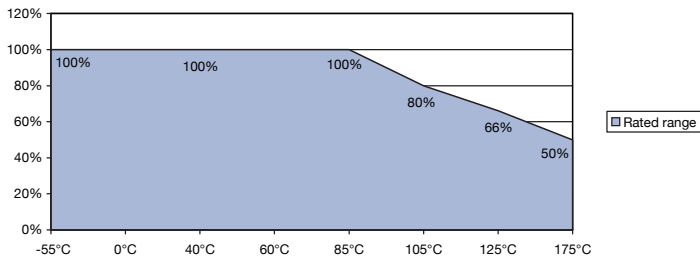

THJ Series

High Temperature Tantalum Chip Capacitor



RATINGS & PART NUMBER REFERENCE

AVX Part No.	Case Size	Capacitance (µF)	Rated Voltage (V)	Rated Temperature (°C)	Category Voltage (V)	Category Temperature (°C)	DCL Max. (µA)	DF Max. (%)	ESR Max. @ 100kHz (Ω)	100kHz RMS Current (mA)				MSL
										25°C	85°C	125°C	175°C	
6.3 Volt @ 85°C														
THJA475*006#JN	A	4.7	6.3	85	3	175	0.5	6	6	112	101	45	22	1
THJA685*006#JN	A	6.8	6.3	85	3	175	0.5	4.5	2.6	170	153	68	34	1
THJA106*006#JN	A	10	6.3	85	3	175	0.6	4.5	2.2	185	166	74	37	1
THJB156*006#JN	B	15	6.3	85	3	175	0.9	6	2.5	184	166	74	37	1
THJB226*006#JN	B	22	6.3	85	3	175	1.4	6	2.5	184	166	74	37	1
THJB336*006#JN	B	33	6.3	85	3	175	2.1	6	2.2	197	177	79	39	1
THJC476*006#JN	C	47	6.3	85	3	175	3.0	6	1.6	262	236	105	52	1
THJC686*006#JN	C	68	6.3	85	3	175	4.3	6	1.5	271	244	108	54	1
THJD107*006#JN	D	100	6.3	85	3	175	6	4.5	0.4	612	551	245	122	1 ¹⁾
THJD157*006#JN	D	150	6.3	85	3	175	9.5	6	0.9	408	367	163	82	1 ¹⁾
10 Volt @ 85°C														
THJA335*010#JN	A	3.3	10	85	5	175	0.5	6	5.5	117	105	47	23	1
THJA475*010#JN	A	4.7	10	85	5	175	0.5	4.5	2.9	161	145	64	32	1
THJA685*010#JN	A	6.8	10	85	5	175	0.7	4.5	2.6	170	153	68	34	1
THJA106*010#JN	A	10	10	85	5	175	1	6	2.7	167	150	67	33	1
THJB106*010#JN	B	10	10	85	5	175	1	4.5	1.8	217	196	87	43	1
THJB156*010#JN	B	15	10	85	5	175	1.5	4.5	1.5	238	214	95	48	1
THJB226*010#JN	B	22	10	85	5	175	2.2	6	2.4	188	169	75	38	1
THJC336*010#JN	C	33	10	85	5	175	3.3	6	1.6	262	236	105	52	1
THJC476*010#JN	C	47	10	85	5	175	4.7	4.5	0.5	469	422	188	94	1
THJD686*010#JN	D	68	10	85	5	175	6.8	4.5	0.4	612	551	245	122	1 ¹⁾
THJD107*010#JN	D	100	10	85	5	175	10	6	0.9	408	367	163	82	1 ¹⁾
THJE227*010#JN	E	220	10	85	5	175	22	10	0.5	574	517	230	115	1 ¹⁾
16 Volt @ 85°C														
THJA225*016#JN	A	2.2	16	85	8	175	0.5	4.5	3	158	142	63	32	1
THJA225*016#1500	A	2.2	16	85	8	175	0.5	4.5	1.5	224	201	89	45	1
THJA335*016#JN	A	3.3	16	85	8	175	0.5	6	5	122	110	49	24	1
THJA475*016#JN	A	4.7	16	85	8	175	0.8	4.5	2.9	161	145	64	32	1
THJB475*016#JN	B	4.7	16	85	8	175	0.8	6	3.5	156	140	62	31	1
THJA685*016#JN	A	6.8	16	85	8	175	1.1	6	3.5	146	132	59	29	1
THJB685*016#JN	B	6.8	16	85	8	175	1.1	6	2.5	184	166	74	37	1
THJB106*016#JN	B	10	16	85	8	175	1.6	4.5	2.8	174	157	70	35	1
THJB156*016#JN	B	15	16	85	8	175	2.4	6	2	206	186	82	41	1
THJC226*016#JN	C	22	16	85	8	175	3.5	6	1.6	262	236	105	52	1
THJC226*016#0500	C	22	16	85	8	175	3.5	4.5	0.5	469	422	188	94	1
THJC336*016#JN	C	33	16	85	8	175	5.3	6	1.5	271	244	108	54	1
THJC476*016#JN	C	47	16	85	8	175	7.5	6	0.8	371	334	148	74	1
THJD476*016#JN	D	47	16	85	8	175	7.5	6	0.9	408	367	163	82	1 ¹⁾
THJD686*016#JN	D	68	16	85	8	175	10.9	4.5	0.9	408	367	163	82	1 ¹⁾
THJE107*016#JN	E	100	16	85	8	175	16	8	0.4	642	578	257	128	1 ¹⁾
20 Volt @ 85°C														
THJA155*020#JN	A	1.5	20	85	10	175	0.5	6	6.5	107	97	43	21	1
THJB335*020#JN	B	3.3	20	85	10	175	0.7	6	3	168	151	67	34	1
THJC156*020#JN	C	15	20	85	10	175	3.0	6	1.7	254	229	102	51	1
THJD336*020#JN	D	33	20	85	10	175	6.6	6	0.9	408	367	163	82	1 ¹⁾
25 Volt @ 85°C														
THJA474*025#JN	A	0.47	25	85	12	175	0.5	4	14	73	66	29	15	1
THJA684*025#JN	A	0.68	25	85	12	175	0.5	4	10	87	78	35	17	1
THJA105*025#JN	A	1.0	25	85	12	175	0.5	3	5.2	120	108	48	24	1
THJB225*025#JN	B	2.2	25	85	12	175	0.6	6	4.5	137	124	55	27	1
THJB225*025#1500	B	2.2	25	85	12	175	0.6	6	1.5	238	214	95	48	1
THJC685*025#JN	C	6.8	25	85	12	175	1.7	6	2	235	211	94	47	1
THJC106*025#JN	C	10	25	85	12	175	2.5	6	1.8	247	222	99	49	1
THJD226*025#JN	D	22	25	85	12	175	5.5	6	0.9	408	367	163	82	1 ¹⁾
THJD336*025#JN	D	33	25	85	12	175	8.3	6	0.9	408	367	163	82	1 ¹⁾
35 Volt @ 85°C														
THJA104*035#JN	A	0.1	35	85	17	175	0.5	4	24	56	50	22	11	1
THJA154*035#JN	A	0.15	35	85	17	175	0.5	4	21	60	54	24	12	1
THJA224*035#JN	A	0.22	35	85	17	175	0.5	4	18	65	58	26	13	1
THJA334*035#JN	A	0.33	35	85	17	175	0.5	4	15	71	64	28	14	1
THJB474*035#JN	B	0.47	35	85	17	175	0.5	4	10	92	83	37	18	1
THJB684*035#JN	B	0.68	35	85	17	175	0.5	4	8	103	93	41	21	1
THJA105*035#JN	A	1.0	35	85	17	175	0.5	4	7.5	100	90	40	20	1
THJB105*035#JN	B	1.0	35	85	17	175	0.5	4	6.5	114	103	46	23	1
THJC155*035#JN	C	1.5	35	85	17	175	0.5	6	4.5	156	141	63	31	1
THJC225*035#JN	C	2.2	35	85	17	175	0.8	6	3.5	177	160	71	35	1
THJC335*035#JN	C	3.3	35	85	17	175	1.2	6	2.5	210	189	84	42	1
THJC475*035#JN	C	4.7	35	85	17	175	1.6	6	2.2	224	201	89	45	1
THJD685*035#JN	D	6.8	35	85	17	175	2.4	6	1.3	340	306	136	68	1 ¹⁾

THJ Series

High Temperature Tantalum Chip Capacitor



RATINGS & PART NUMBER REFERENCE

AVX Part No.	Case Size	Capacitance (μF)	Rated Voltage (V)	Rated Temperature (°C)	Category Voltage (V)	Category Temperature (°C)	DCL Max. (μA)	DF Max. (%)	ESR Max. @ 100kHz (Ω)	100kHz RMS Current (mA)				MSL
										25°C	85°C	125°C	175°C	
THJD106*035#JN	D	10	35	85	17	175	3.5	6	1	387	349	155	77	1 ¹⁾
THJD156*035#JN	D	15	35	85	17	175	5.3	6	0.9	408	367	163	82	1 ¹⁾
THJD226*035#JN	D	22	35	85	17	175	7.7	6	0.6	500	450	200	100	1 ¹⁾
THJD226*035#0300	D	22	35	85	17	175	7.7	6	0.3	707	636	283	141	1 ¹⁾
THJE336*035#JN	E	33	35	85	17	175	11.6	6	0.5	574	517	230	115	1 ¹⁾
THJE336*035#0150	E	33	35	85	17	175	11.6	6	0.15	1049	944	420	210	1 ¹⁾
50 Volt @ 85°C														
THJD335*050#JN	D	3.3	50	85	25	175	1.7	6	1.1	369	332	148	74	1 ¹⁾
THJD475*050#JN	D	4.7	50	85	25	175	2.4	6	0.9	463	417	185	93	1 ¹⁾
THJD685*050#JN	D	6.8	50	85	25	175	3.4	6	0.7	408	367	163	82	1 ¹⁾
THJD106*050#JN	D	10	50	85	25	175	5	6	0.7	463	417	185	93	1 ¹⁾
THJE106*050#JN	E	10	50	85	25	175	5	6	0.7	486	437	194	97	1 ¹⁾

Moisture Sensitivity Level (MSL) is defined according to J-STD-020.

All PNs also available with Dry pack option - MSL 3 (see How to order).

¹⁾ - Dry pack option (see How to order) is recommended for reduction of stress during soldering.

All technical data relates to an ambient temperature of +25°C. Capacitance and DF are measured at 120Hz, 0.5V RMS with a maximum DC bias of 2.2 volts.

DCL is measured at rated voltage after 5 minutes.

The EIA & CECC standards for low ESR Solid Tantalum Capacitors allow an ESR movement to 1.25 times catalogue limit post mounting.

For typical weight and composition see page 274.

NOTE: AVX reserves the right to supply higher voltage ratings or tighter tolerance part in the same case size, to the same reliability standards.

THJ Series

High Temperature Tantalum Chip Capacitor

QUALIFICATION TABLE

TEST	THJ series (Temperature range -55°C to +175°C)									
	Condition			Characteristics						
Endurance	Apply rated voltage (Ur) at 85°C and / or category voltage (Uc) at 175°C for 2000 hours through a circuit impedance of $\leq 0.1\Omega/V$. Stabilize at room temperature for 1-2 hours before measuring.			Visual examination	no visible damage					
				DCL	1.25 x initial limit					
				$\Delta C/C$	within $\pm 10\%$ of initial value					
				DF	initial limit					
				ESR	1.25 x initial limit					
Storage Life	Store at 175°C, no voltage applied, for 2000 hours. Stabilize at room temperature for 1-2 hours before measuring.			Visual examination	no visible damage					
				DCL	1.25 x initial limit					
				$\Delta C/C$	within $\pm 10\%$ of initial value					
				DF	initial limit					
				ESR	1.25 x initial limit					
Biased Humidity	Apply rated voltage (Ur) at 85°C, 85% relative humidity for 1000 hours. Stabilize at room temperature and humidity for 1-2 hours before measuring.			Visual examination	no visible damage					
				DCL	2 x initial limit					
				$\Delta C/C$	within $\pm 10\%$ of initial value					
				DF	1.2 x initial limit					
				ESR	1.25 x initial limit					
Temperature Stability	Step	Temperature°C	Duration(min)		+20°C	-55°C	+20°C	+125°C	+175°C	+20°C
	1	+20	15	DCL	IL*	n/a	IL*	10 x IL*	12.5 x IL*	IL*
	2	-55	15		$\Delta C/C$	n/a	+0/-10%	$\pm 5\%$	+10/-0%	+18/-0%
	3	+20	15	DF	IL*	1.5 x IL*	IL*	1.5 x IL*	2 x IL*	IL*
	4	+125	15	ESR	1.25xIL*	2.5xIL*	1.25xIL*	1.25xIL*	1.25xIL*	1.25xIL*
	5	+175	15							
	6	+20	15							
Surge Voltage	Apply 1.3x category voltage (Uc) at 175°C for 1000 cycles of duration 6 min (30 sec charge, 5 min 30 sec discharge) through a charge / discharge resistance of 1000 Ω			Visual examination	no visible damage					
				DCL	initial limit					
				$\Delta C/C$	within $\pm 5\%$ of initial value					
				DF	initial limit					
				ESR	1.25 x initial limit					
Mechanical Shock	MIL-STD-202, Method 213, Condition F			Visual examination	no visible damage					
				DCL	initial limit					
				$\Delta C/C$	within $\pm 5\%$ of initial value					
				DF	initial limit					
				ESR	1.25 x initial limit					
Vibration	MIL-STD-202, Method 204, Condition D			Visual examination	no visible damage					
				DCL	initial limit					
				$\Delta C/C$	within $\pm 5\%$ of initial value					
				DF	initial limit					
				ESR	1.25 x initial limit					

*Initial Limit

THJ Series

High Temperature Tantalum Chip Capacitor



AVX SOLID ELECTROLYTIC CAPACITOR ROADMAP

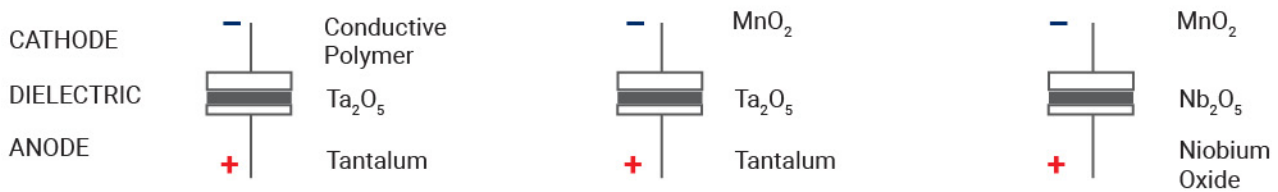
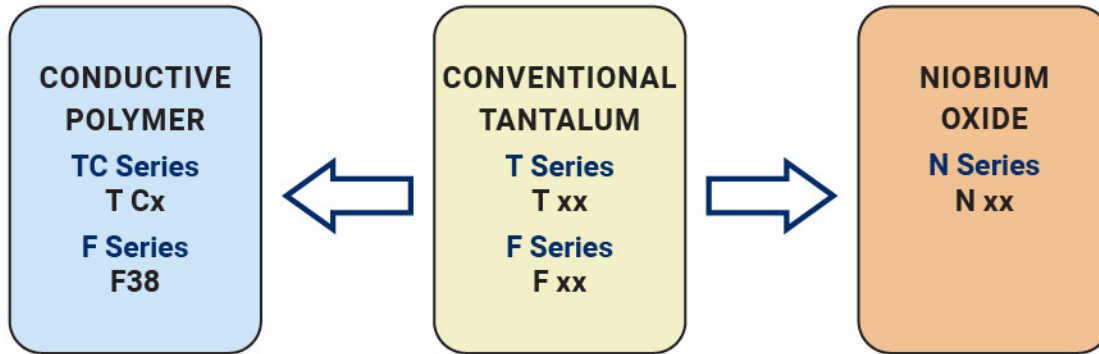

FIVE CAPACITOR CONSTRUCTION STYLES

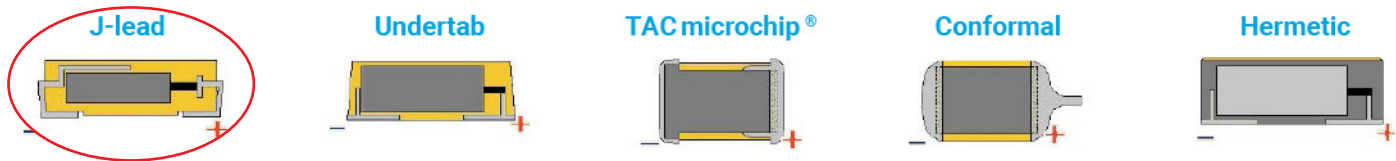

SERIES LINE UP : CONVENTIONAL SMD MnO₂

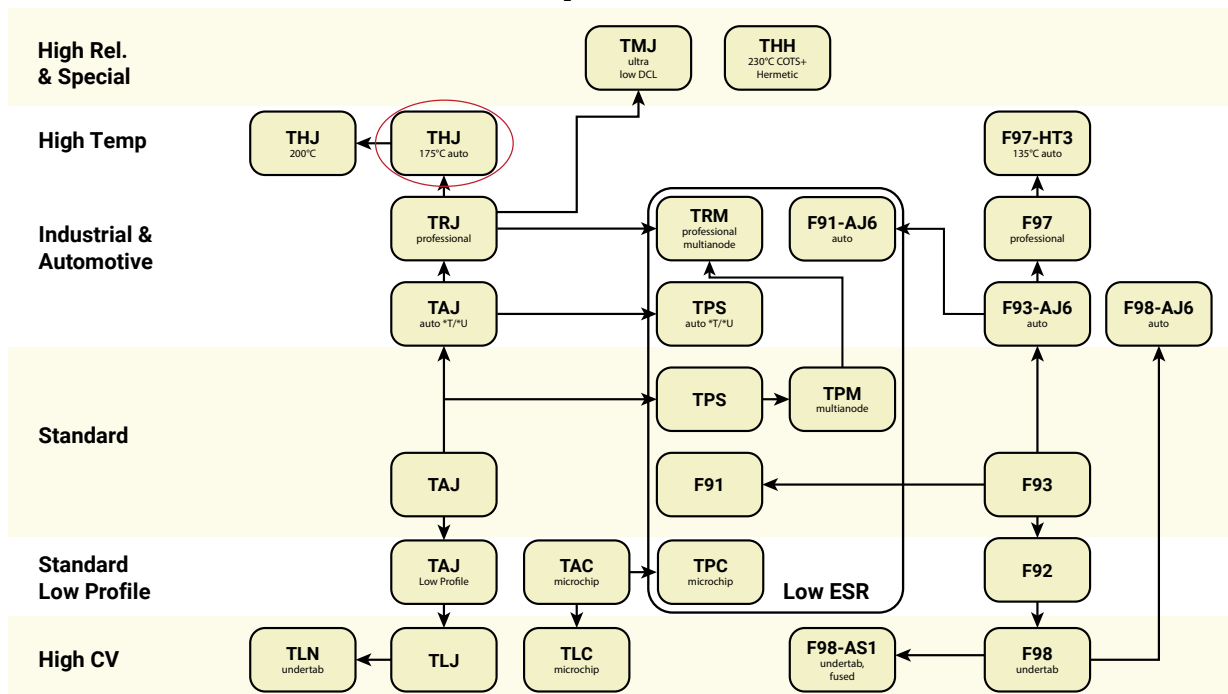

THJ Extended Series

High Temperature (200°C max.) - J-Lead

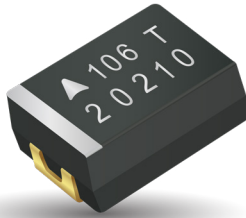

FEATURES

- SMD 200°C Tantalum Capacitor
- 200°C @ 0.33V_R 1000hrs Continuous Operation
- Leakage Current After 200°C 1000hrs Less than 1mA
- 3x Reflow 260°C
- 100% Surge Current Tested
- Gold Plated Termination for Hybrid Assembly
- Oil Drilling, Aerospace, Automotive Applications
- CV Range: 10-220µF / 10-16V
- 2 Case Sizes Available



LEAD-FREE
LEAD-FREE COMPATIBLE
COMPONENT



RoHS
COMPLIANT

APPLICATIONS

- Downhole Drilling

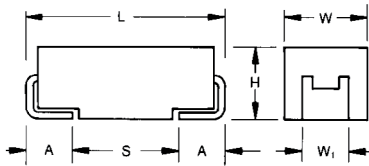

CASE DIMENSIONS:

millimeters (inches)

Code	EIA Code	EIA Metric	L±0.20 (0.008)	W+0.20 (0.008) -0.10 (0.004)	H+0.20 (0.008) -0.10 (0.004)	W ₁ ±0.20 (0.008)	A+0.30 (0.012) -0.20 (0.008)	S Min.
B	1210	3528-21	3.50 (0.138)	2.80 (0.110)	1.90 (0.075)	2.20 (0.087)	0.80 (0.031)	1.40 (0.055)
E	2917	7343-43	7.30 (0.287)	4.30 (0.169)	4.10 (0.162)	2.40 (0.094)	1.30 (0.051)	4.40 (0.173)

W₁ dimension applies to the termination width for A dimensional area only.

MARKING

B, E CASE

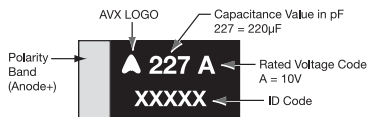

HOW TO ORDER

THJ	E	107	*	016	#	JH	-
Type	Case Size See table above	Capacitance Code pF code: 1st two digits represent significant figures 3rd digit represents multiplier (number of zeros to follow)	Tolerance K = ±10% M = ±20%	Rated DC Voltage 010 = 10Vdc 016 = 16Vdc	Packaging A = Gold Plating 7" Reel B = Gold Plating 13" Reel	Standard Suffix	Additional characters may be added for special requirements V = Dry pack Option

TECHNICAL SPECIFICATIONS

Technical Data:	All technical data relate to an ambient temperature of +25°C		
Capacitance Range:	10 µF to 220 µF		
Capacitance Tolerance:	±10%; ±20%		
Leakage Current DCL @ V _R 25°C	0.01CV		
Leakage Current DCL @ V _C 200°C, 1000 hrs	1mA		
Rated Voltage (V _R)	≤ +85°C:	10	16
Category Voltage (V _C)	≤ +200°C:	3.3	5.3
Surge Voltage (V _S)	≤ +85°C:	13	20
Surge Voltage (V _S)	≤ +200°C:	4.3	6.5
Temperature Range:	-55°C up 200°C with voltage derating		
Reliability:	0.5% per 1000 hours at 85°C, V _R with 0.1Ω/V series impedance, 1000 hrs at 200°C, 0.33V _R		
Termination Finished:	Gold Plating		

THJ Extended Series

High Temperature (200°C max.) - J-Lead



CAPACITANCE AND RATED VOLTAGE RANGE (LETTER DENOTES CASE SIZE)

Capacitance		Rated voltage (V _R) to 85°C (Voltage Code)	
µF	Code	10V (A)	16V (C)
10	106		B
15	156		
100	107		E
150	157		
220	227	E	

Released ratings

Note: Voltage ratings are minimum values. AVX reserves the right to supply higher voltage ratings in the same case size, to the same reliability standards.

RATINGS & PART NUMBER REFERENCE

AVX Part No.	Case Size	Capacitance (µF)	Rated Voltage (V)	Rated Temperature (°C)	Category Voltage (V)	Category Temperature (°C)	DCL Max. @ V _R 25°C (µA)	DCL Max. @ VC 200°C 1000 hrs (mA)	DF Max. (%)	ESR Max. @ 100kHz (Ω)	100kHz RMS Current (mA)				MSL
											25°C	85°C	175°C	200°C	
10 Volt @ 85°C															
THJE227*010#JH	E	220	10	85	3.3	200	22	1.0	10	0.25	812	731	162	81	1 ¹⁾
16 Volt @ 85°C															
THJB106*016#JH	B	10	16	85	5.3	200	1.6	1.0	6	2.8	174	157	35	17	1
THJE107*016#JH	E	100	16	85	5.3	200	16	1.0	8	0.25	812	731	162	81	1 ¹⁾

Moisture Sensitivity Level (MSL) is defined according to J-STD-020.

All PNs also available with Dry pack option - MSL 3 (see How to order).

¹⁾ - Dry pack option (see How to order) recommended for reduction of stress during soldering.

Base terminations material is copper for E case size and Ni1042 for B case size.

All technical data relates to an ambient temperature of +25°C. Capacitance and DF are measured at 120Hz, 0.5V RMS with a maximum DC bias of 2.2 volts.

DCL is measured at rated voltage after 5 minutes.

For typical weight and composition see page 274.

NOTE: AVX reserves the right to supply higher voltage ratings or tighter tolerance part in the same case size, to the same reliability standards.

THJ Extended Series

High Temperature (200°C max.) - J-Lead

QUALIFICATION TABLE

TEST	THJ 200°C series (Temperature range -55°C to +200°C)									
	Condition			Characteristics						
Endurance	Apply rated voltage (Ur) at 85°C and / or category voltage (Uc) at 200°C for 2000 hours through a circuit impedance of $\leq 0.1\Omega/V$. Stabilize at room temperature for 1-2 hours before measuring.			Visual examination	no visible damage					
				DCL	1.25 x initial limit					
				$\Delta C/C$	within $\pm 10\%$ of initial value					
				DF	initial limit					
				ESR	1.25 x initial limit					
Storage Life	Store at 200°C, no voltage applied, for 2000 hours. Stabilize at room temperature for 1-2 hours before measuring.			Visual examination	no visible damage					
				DCL	1.25 x initial limit					
				$\Delta C/C$	within $\pm 10\%$ of initial value					
				DF	initial limit					
				ESR	1.25 x initial limit					
Biased Humidity	Apply rated voltage (Ur) at 85°C, 85% relative humidity for 1000 hours. Stabilize at room temperature and humidity for 1-2 hours before measuring.			Visual examination	no visible damage					
				DCL	2 x initial limit					
				$\Delta C/C$	within $\pm 10\%$ of initial value					
				DF	1.2 x initial limit					
				ESR	1.25 x initial limit					
Temperature Stability	Step	Temperature°C	Duration(min)		+20°C	-55°C	+20°C	+125°C	+200°C	+20°C
	1	+20	15	DCL	IL*	n/a	IL*	10 x IL*	12.5 x IL*	IL*
	2	-55	15		$\Delta C/C$	n/a	+0/-10%	$\pm 5\%$	+10/-0%	+18/-0%
	3	+20	15	DF	IL*	1.5 x IL*	IL*	1.5 x IL*	2 x IL*	IL*
	4	+85	15		ESR	1.25xIL*	2.5xIL*	1.25xIL*	1.25xIL*	1.25xIL*
	5	+125	15							
6	+20	15								
Surge Voltage	Apply 1.3x category voltage (Uc) at 200°C for 1000 cycles of duration 6 min (30 sec charge, 5 min 30 sec discharge) through a charge / discharge resistance of 1000 Ω			Visual examination	no visible damage					
				DCL	initial limit					
				$\Delta C/C$	within $\pm 5\%$ of initial value					
				DF	initial limit					
				ESR	1.25 x initial limit					
Mechanical Shock	MIL-STD-202, Method 213, Condition C			Visual examination	no visible damage					
				DCL	initial limit					
				$\Delta C/C$	within $\pm 5\%$ of initial value					
				DF	initial limit					
				ESR	initial limit					
Vibration	MIL-STD-202, Method 204, Condition D			Visual examination	no visible damage					
				DCL	initial limit					
				$\Delta C/C$	within $\pm 5\%$ of initial value					
				DF	initial limit					
				ESR	initial limit					

*Initial Limit

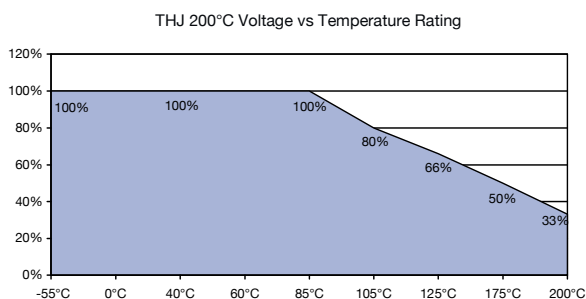

THJ Extended Series

High Temperature (200°C max.) - J-Lead

AVX SOLID ELECTROLYTIC CAPACITOR ROADMAP

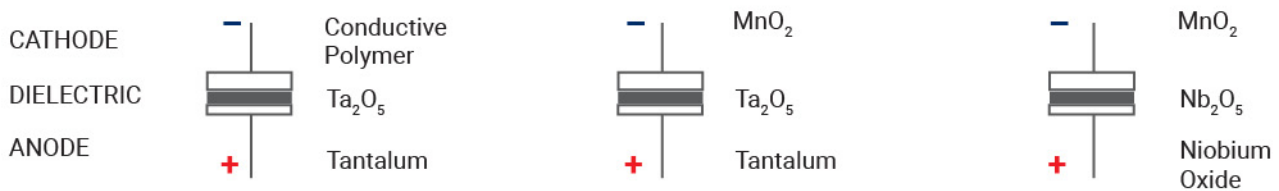
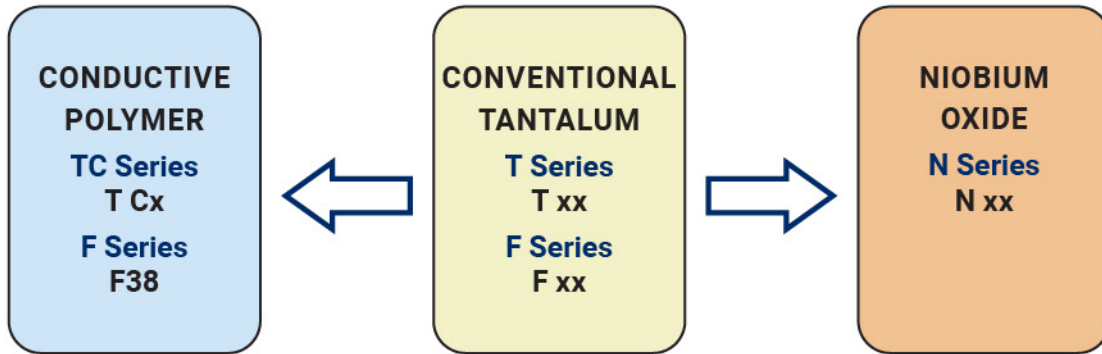

FIVE CAPACITOR CONSTRUCTION STYLES

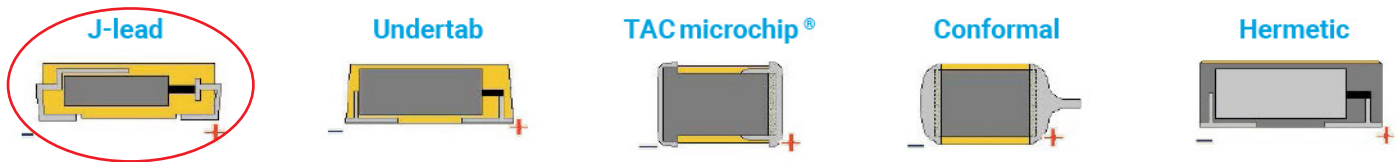

SERIES LINE UP : CONVENTIONAL SMD MnO₂

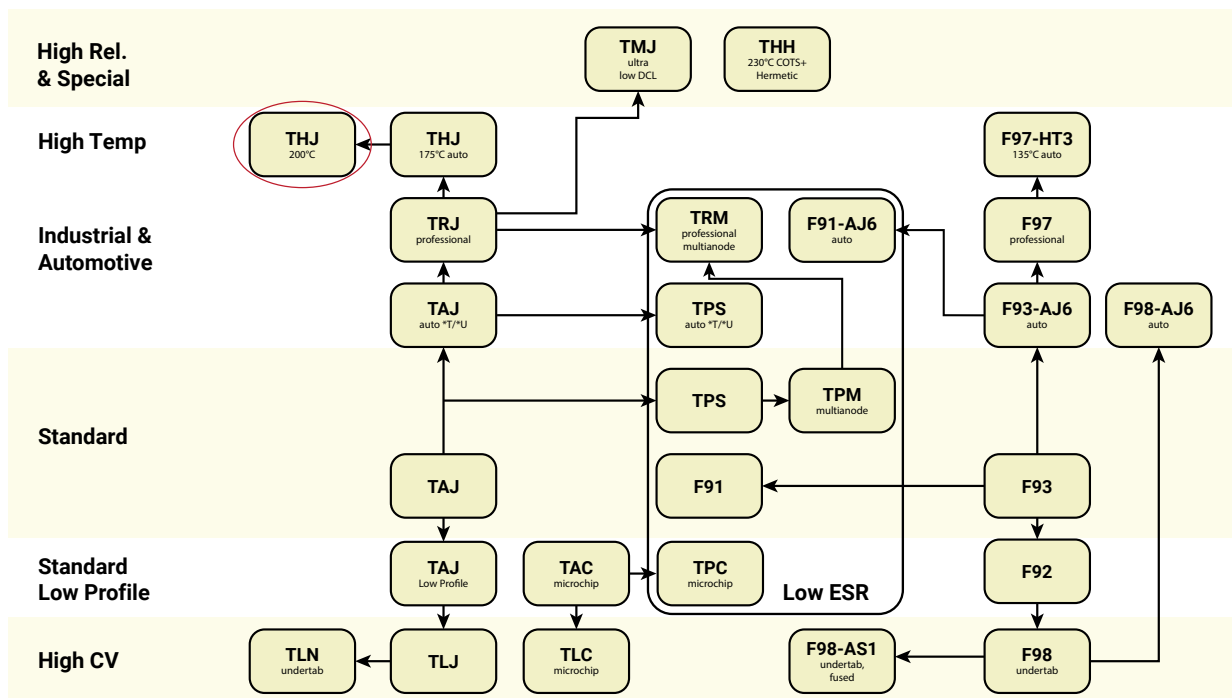

TAC Series

Standard and Low Profile Tantalum Microchip Capacitors

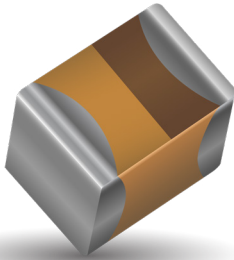

FEATURES

- The World's Smallest Surface Mount Tantalum Capacitor
- 100% Surge Current Tested
- CV Range: 0.10-150µF / 2-25V
- 11 Case Sizes Available, Standard and Low Profile



LEAD-FREE
LEAD-FREE COMPATIBLE
COMPONENT

APPLICATIONS

- Hearing Aids, Non-Life Support Medical, Long Life Miniature Designs
- Industrial and Hand-held and Wearable Applications

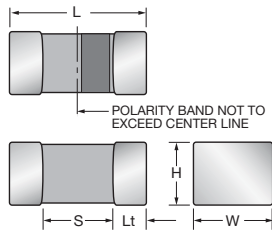

MARKING

A, B, H, I, J, K, L, R, T, U, V CASE

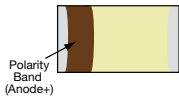

STANDARD CASE DIMENSIONS:

millimeters (inches)

Code	EIA Code	EIA Metric	L+0.20 (0.008) -0.00 (0.000)	W+0.15 (0.006) -0.00 (0.000)	H+0.15 (0.006) -0.00 (0.000)	Termination Spacing(S)	Minimum Termination Length (Lt)
A	1206	3216-18	3.20 ± 0.20 (0.126 ± 0.008)	1.60 ± 0.20 (0.063 ± 0.008)	1.60 ± 0.20 (0.063 ± 0.008)	1.80 (0.071) min	0.15 (0.006)
B	1210	3528-15	3.50 ± 0.20 (0.138 ± 0.008)	2.80 ^{+0.20} _{-0.10} (0.110 ^{+0.008} _{-0.004})	1.50 (0.059) max	2.00 (0.079) min	0.15 (0.006)
K	0402	1005-07	1.00 (0.039)	0.50 ^{+0.20} _{-0.10} (0.020 ^{+0.008} _{-0.004})	0.50 ^{+0.20} _{-0.10} (0.020 ^{+0.008} _{-0.004})	0.40 (0.016) min	0.10 (0.004)
L	0603	1608-10	1.60 (0.063)	0.85 (0.033)	0.85 (0.033)	0.55 (0.022) min	0.15 (0.006)
R	0805	2012-15	2.00 (0.079)	1.35 (0.053)	1.35 (0.053)	0.70 (0.028) min	0.15 (0.006)

LOW PROFILE CASE DIMENSIONS:

millimeters (inches)

Code	EIA Code	EIA Metric	L+0.20 (0.008) -0.00 (0.000)	W+0.15 (0.006) -0.00 (0.000)	H max	Termination Spacing(S)	Minimum Termination Length (Lt)
H	0805	2012-10	2.00 (0.079)	1.35 (0.053)	1.00 (0.039)	0.70 (0.028) min	0.15 (0.006)
I	1206	3216-05	3.20 ± 0.20 (0.126 ± 0.008)	1.60 ± 0.20 (0.063 ± 0.008)	0.50 (0.020)	1.80 (0.071) min.	0.15 (0.006)
J	0603	1608-08	1.60 (0.063)	0.85 (0.033)	0.75 (0.030)	0.55 (0.022) min	0.15 (0.006)
T	1210	3528-12	3.50 ± 0.20 (0.138 ± 0.008)	2.80 ^{+0.20} _{-0.10} (0.110 ^{+0.008} _{-0.004})	1.20 (0.047)	2.00 (0.079) min	0.15 (0.006)
U	0805	2012-06	2.00 (0.079)	1.35 (0.053)	0.60 (0.024)	0.70 (0.028) min	0.15 (0.006)
V	1206	3216-08	3.20 ± 0.20 (0.126 ± 0.008)	1.60 ± 0.20 (0.063 ± 0.008)	0.75 (0.030)	1.80 (0.071) min	0.15 (0.006)

HOW TO ORDER

TAC	L	226	*	004	R	TA
Type TACmicrochip®	Case Size See table above	Capacitance Code pF code: 1st two digits represent significant figures, 3rd digit represents multiplier (number of zeros to follow)	Tolerance K = ±10% M = ±20%	Rated DC Voltage 002=2Vdc 003=3Vdc 004=4Vdc 006=6.3Vdc 010=10Vdc 016=16Vdc 020=20Vdc 025=25Vdc	Packaging R, P = 7" Standard Tin Termination Plastic Tape X, Q = 41/4" Standard Tin Termination Plastic Tape A, M = 7" Gold Termination Plastic Tape F, N = 4 1/4" Gold Termination Plastic Tape	Alternative characters may be used for special requirements

TECHNICAL SPECIFICATIONS

Technical Data:		All technical data relate to an ambient temperature of +25°C								
Capacitance Range:		0.10 µF to 150 µF								
Capacitance Tolerance:		±10%; ±20%								
Leakage Current DCL:		0.01CV or 0.5µA whichever is the greater								
Rated Voltage (V _R)	≤ +85°C:	2	3	4	6.3	10	16	20	25	
Category Voltage (V _C)	≤ +125°C:	1.3	2	2.7	4	7	10	13	17	
Surge Voltage (V _S)	≤ +85°C:	2.7	3.9	5.2	8	13	20	26	32	
Surge Voltage (V _S)	≤ +125°C:	1.7	2.6	3.2	5	8	12	16	20	
Temperature Range:		-55°C to +125°C								
Reliability:		1% per 1000 hours at 85°C, V _R with 0.1Ω/V series impedance, 60% confidence level								
Termination Finish:		Tin Plating over Nickel (standard), Gold Plating over Nickel option available upon request								

TAC Series

Standard and Low Profile Tantalum Microchip Capacitors



STANDARD MICROCHIP CAPACITANCE AND RATED VOLTAGE RANGE (LETTER DENOTES CASE SIZE)

Capacitance		Voltage Rating DC (V _r) at 85°C							
μF	Code	2.0V	3.0V	4.0V	6.3V	10V	16V	20V	25V
0.10	104						K		
0.15	154					K	K		
0.22	224					K	K	K	
0.33	334					K	K		
0.47	474					K/L	L		
0.68	684					K/L	L		
1.0	105				K/L	K/L/R	L		R
1.5	155			L	L	L			
2.2	225		K/L		K/L	L	L		
3.3	335	K/L	K/L	L	L	L/R		R	
4.7	475	K/L	K/L	L	L	L/R		R	
6.8	685	K/L	L	L	L/R	L/R			
10	106	K/L	L	L/R	L/R	L/R	R		
15	156		R	L/R	L/R	R			
22	226	R	L/R	L/R	R	R			
33	336	R	R	R	R	A/R			
47	476	R	R	R	A/R	B			
68	686	R	A/R	A					
100	107		A/R	A/R	A				
150	157	A							
220	227								

LOW PROFILE MICROCHIP CAPACITANCE AND RATED VOLTAGE RANGE (LETTER DENOTES CASE SIZE)

Capacitance		Voltage Rating DC (V _r) at 85°C					
μF	Code	2.0V	3.0V	4.0V	6.3V	10V	16V
1.0	105						U
1.5	155						
2.2	225					U	
3.3	335				U		
4.7	475			U			
6.8	685						
10	106	U		J	J ^(M)	H/V	
15	156				H	V	
22	226				H		
33	336			H			
47	476		H			T	
68	686				T		
100	107				T		

Released ratings (M tolerance only)

Note: Voltage ratings are minimum values. AVX reserves the right to supply higher voltage ratings in the same case size, to the same reliability standards.

TAC Series

Standard and Low Profile Tantalum Microchip Capacitors



RATINGS & PART NUMBER REFERENCE

AVX Part No.	Case Size	Capacitance (µF)	Rated Voltage (V)	Rated Temperature (°C)	Category Voltage (V)	Category Temperature (°C)	DCL Max. (µA)	DF Max. (%)	ESR Max. @ 100kHz (Ω)	100kHz RMS Current (mA)			Product Category	MSL
										25°C	85°C	125°C		
2 Volt @ 85°C														
TACK335*002#TA	K	3.3	2	85	1.3	125	0.5	8	15	32	28	13	3	1
TACL335*002#TA	L	3.3	2	85	1.3	125	0.5	6	7.5	58	52	23	2	1
TACK475*002#TA	K	4.7	2	85	1.3	125	0.5	12	15	32	28	13	3	1
TACL475*002#TA	L	4.7	2	85	1.3	125	0.5	6	7.5	58	52	23	1	1
TACK685*002#TA	K	6.8	2	85	1.3	125	0.5	20	15	32	28	13	3	1
TACL685*002#TA	L	6.8	2	85	1.3	125	0.5	6	7.5	58	52	23	2	1
TACK106*002#TA	K	10	2	85	1.3	125	0.5	15	15	32	28	13	3	1
TACL106*002#TA	L	10	2	85	1.3	125	0.5	10	7.5	58	52	23	3	1
TACU106*002#TA	U	10	2	85	1.3	125	0.5	8	5	84	75	33	1	1
TACR226*002#TA	R	22	2	85	1.3	125	0.5	8	5	95	85	38	1	1
TACR336*002#TA	R	33	2	85	1.3	125	0.7	10	5	95	85	38	2	1
TACR476*002#TA	R	47	2	85	1.3	125	0.9	10	5	95	85	38	2	1
TACR686*002#TA	R	68	2	85	1.3	125	1.4	14	5	95	85	38	2	1
TACA157*002#TA	A	150	2	85	1.3	125	3	20	1	200	180	80	2	1
3 Volt @ 85°C														
TACK225*003#TA	K	2.2	3	85	2	125	0.5	6	15	32	28	13	2	1
TACL225*003#TA	L	2.2	3	85	2	125	0.5	6	7.5	58	52	23	1	1
TACK335*003#TA	K	3.3	3	85	2	125	0.5	8	15	32	28	13	3	1
TACL335*003#TA	L	3.3	3	85	2	125	0.5	6	7.5	58	52	23	2	1
TACK475*003#TA	K	4.7	3	85	2	125	0.5	12	15	32	28	13	3	1
TACL475*003#TA	L	4.7	3	85	2	125	0.5	6	7.5	58	52	23	1	1
TACL685*003#TA	L	6.8	3	85	2	125	0.5	6	7.5	58	52	23	2	1
TACL106*003#TA	L	10	3	85	2	125	0.5	10	7.5	58	52	23	3	1
TACR156*003#TA	R	15	3	85	2	125	0.5	8	5	95	85	38	1	1
TACL226*003#TA	L	22	3	85	2	125	0.7	20	7.5	58	52	23	3	1
TACR226*003#TA	R	22	3	85	2	125	0.7	8	5	95	85	38	1	1
TACR336*003#TA	R	33	3	85	2	125	1	10	5	95	85	38	2	1
TACH476*003#TA	H	47	3	85	2	125	1.4	20	5	89	80	36	3	1
TACR476*003#TA	R	47	3	85	2	125	1.5	10	5	95	85	38	2	1
TACA686*003#TA	A	68	3	85	2	125	2	15	2	141	127	57	1	1
TACR686*003#TA	R	68	3	85	2	125	2	14	5	95	85	38	3	1
TACA107*003#TA	A	100	3	85	2	125	3	15	1	200	180	80	2	1
TACR107*003#TA	R	100	3	85	2	125	3	30	5	95	85	38	3	1
4 Volt @ 85°C														
TACL155*004#TA	L	1.5	4	85	2.7	125	0.5	6	7.5	58	52	23	1	1
TACL225*004#TA	L	2.2	4	85	2.7	125	0.5	6	7.5	58	52	23	1	1
TACL335*004#TA	L	3.3	4	85	2.7	125	0.5	6	7.5	58	52	23	2	1
TACL475*004#TA	L	4.7	4	85	2.7	125	0.5	6	7.5	58	52	23	1	1
TACU475*004#TA	U	4.7	4	85	2.7	125	0.5	8	5	84	75	33	1	1
TACL685*004#TA	L	6.8	4	85	2.7	125	0.5	8	7.5	58	52	23	2	1
TACJ106*004#TA	J	10	4	85	2.7	125	0.5	20	7.5	52	46	21	3	1
TACL106*004#TA	L	10	4	85	2.7	125	0.5	10	7.5	58	52	23	2	1
TACR106*004#TA	R	10	4	85	2.7	125	0.5	8	5	95	85	38	1	1
TACL156*004#TA	L	15	4	85	2.7	125	0.6	20	7.5	58	52	23	3	1
TACR156*004#TA	R	15	4	85	2.7	125	0.6	8	5	95	85	38	1	1
TACL226*004#TA	L	22	4	85	2.7	125	0.9	20	7.5	58	52	23	3	1
TACR226*004#TA	R	22	4	85	2.7	125	0.9	8	5	95	85	38	1	1
TACH336*004#TA	H	33	4	85	2.7	125	1.3	14	5	89	80	36	2	1
TACR336*004#TA	R	33	4	85	2.7	125	1.3	10	5	95	85	38	2	1
TACR476*004#TA	R	47	4	85	2.7	125	1.9	14	5	95	85	38	3	1
TACA686*004#TA	A	68	4	85	2.7	125	2.7	15	1	200	180	80	1	1
TACA107*004#TA	A	100	4	85	2.7	125	4	20	1	200	180	80	2	1
TACR107*004#TA	R	100	4	85	2.7	125	4	30	5	95	85	38	3	1
6.3 Volt @ 85°C														
TACK105*006#TA	K	1	6.3	85	4	125	0.5	6	15	32	28	13	2	1
TACL105*006#TA	L	1	6.3	85	4	125	0.5	6	7.5	58	52	23	1	1
TACL155*006#TA	L	1.5	6.3	85	4	125	0.5	6	7.5	58	52	23	1	1
TACK225*006#TA	K	2.2	6.3	85	4	125	0.5	8	15	32	28	13	3	1
TACL225*006#TA	L	2.2	6.3	85	4	125	0.5	6	7.5	58	52	23	1	1
TACL335*006#TA	L	3.3	6.3	85	4	125	0.5	6	7.5	58	52	23	2	1
TACU335*006#TA	U	3.3	6.3	85	4	125	0.5	8	5	84	75	33	1	1
TACL475*006#TA	L	4.7	6.3	85	4	125	0.5	8	7.5	58	52	23	2	1
TACL685*006#TA	L	6.8	6.3	85	4	125	0.5	10	7.5	58	52	23	2	1
TACR685*006#TA	R	6.8	6.3	85	4	125	0.5	8	5	95	85	38	1	1
TACH106M006#TA	I	10	6.3	85	4	125	0.6	20	5	84	75	33	2	1
TACL106*006#TA	L	10	6.3	85	4	125	0.6	10	6	65	58	26	2	1
TACR106*006#TA	R	10	6.3	85	4	125	0.6	8	5	95	85	38	1	1
TACH156*006#TA	H	15	6.3	85	4	125	0.9	8	5	89	80	36	3	1
TACL156*006#TA	L	15	6.3	85	4	125	0.9	20	7.5	58	52	23	3	1
TACR156*006#TA	R	15	6.3	85	4	125	0.9	8	5	95	85	38	1	1

TAC Series

Standard and Low Profile Tantalum Microchip Capacitors



RATINGS & PART NUMBER REFERENCE

AVX Part No.	Case Size	Capacitance (µF)	Rated Voltage (V)	Rated Temperature (°C)	Category Voltage (V)	Category Temperature (°C)	DCL Max. (µA)	DF Max. (%)	ESR Max. @ 100kHz (Ω)	100kHz RMS Current (mA)			Product Category	MSL
										25°C	85°C	125°C		
TACH226*006#TA	H	22	6.3	85	4	125	1.4	10	5	89	80	36	2	1
TACR226*006#TA	R	22	6.3	85	4	125	1.4	10	5	95	85	38	1	1
TACR336*006#TA	R	33	6.3	85	4	125	2.1	12	5	95	85	38	2	1
TACA476*006#TA	A	47	6.3	85	4	125	3	15	1	200	180	80	1	1
TACR476*006#TA	R	47	6.3	85	4	125	3	20	5	95	85	38	3	1
TACT686*006#TA	T	68	6.3	85	4	125	4.3	15	1	200	180	80	2	1
TACA107*006#TA	A	100	6.3	85	4	125	6.3	20	1	200	180	80	2	1
TACT107*006#TA	T	100	6.3	85	4	125	6.3	12	1	200	180	80	2	1
10 Volt @ 85°C														
TACK154*010#TA	K	0.15	10	85	7	125	0.5	6	40	19	17	8	1	1
TACK224*010#TA	K	0.22	10	85	7	125	0.5	6	30	22	20	9	1	1
TACK334*010#TA	K	0.33	10	85	7	125	0.5	6	20	27	25	11	1	1
TACK474*010#TA	K	0.47	10	85	7	125	0.5	6	15	32	28	13	1	1
TACL474*010#TA	L	0.47	10	85	7	125	0.5	6	7.5	58	52	23	1	1
TACK684*010#TA	K	0.68	10	85	7	125	0.5	8	15	32	28	13	2	1
TACL684*010#TA	L	0.68	10	85	7	125	0.5	6	7.5	58	52	23	1	1
TACK105*010#TA	K	1	10	85	7	125	0.5	6	15	32	28	13	2	1
TACL105*010#TA	L	1	10	85	7	125	0.5	6	7.5	58	52	23	1	1
TACR105*010#TA	R	1	10	85	7	125	0.5	6	7	80	72	32	1	1
TACL155*010#TA	L	1.5	10	85	7	125	0.5	6	7.5	58	52	23	1	1
TACL225*010#TA	L	2.2	10	85	7	125	0.5	6	7.5	58	52	23	1	1
TACU225*010#TA	U	2.2	10	85	7	125	0.5	8	5	84	75	33	1	1
TACL335*010#TA	L	3.3	10	85	7	125	0.5	8	7.5	58	52	23	2	1
TACR335*010#TA	R	3.3	10	85	7	125	0.5	8	5	95	85	38	1	1
TACL475*010#TA	L	4.7	10	85	7	125	0.5	10	6	65	58	26	2	1
TACR475*010#TA	R	4.7	10	85	7	125	0.5	8	6	87	78	35	1	1
TACL685*010#TA	L	6.8	10	85	7	125	0.7	20	7.5	58	52	23	3	1
TACR685*010#TA	R	6.8	10	85	7	125	0.7	8	5	95	85	38	1	1
TACH106*010#TA	H	10	10	85	7	125	1.0	8	5	89	80	36	2	1
TACL106*010#TA	L	10	10	85	7	125	1	20	7.5	58	52	23	3	1
TACR106*010#TA	R	10	10	85	7	125	1	8	5	95	85	38	1	1
TACV106*010#TA	V	10	10	85	7	125	1.0	10	2	132	119	53	2	1
TACR156*010#TA	R	15	10	85	7	125	1.5	10	5	95	85	38	1	1
TACV156*010#TA	V	15	10	85	7	125	1.5	10	2	132	119	53	2	1
TACR226*010#TA	R	22	10	85	7	125	2.2	14	5	95	85	38	2	1
TACA336*010#TA	A	33	10	85	7	125	3.3	12	1	200	180	80	1	1
TACR336*010#TA	R	33	10	85	7	125	3.3	20	5	95	85	38	3	1
TACB476*010#TA	B	47	10	85	7	125	4.7	15	1	200	180	80	1	1
TACT476*010#TA	T	47	10	85	7	125	4.7	12	1	200	180	80	1	1
16 Volt @ 85°C														
TACK104*016#TA	K	0.1	16	85	10	125	0.5	6	40	19	17	8	1	1
TACK154*016#TA	K	0.15	16	85	10	125	0.5	6	30	22	20	9	1	1
TACK224*016#TA	K	0.22	16	85	10	125	0.5	6	20	27	25	11	1	1
TACK334*016#TA	K	0.33	16	85	10	125	0.5	6	20	27	25	11	1	1
TACL474*016#TA	L	0.47	16	85	10	125	0.5	6	7.5	58	52	23	1	1
TACL684*016#TA	L	0.68	16	85	10	125	0.5	6	7.5	58	52	23	1	1
TACL105*016#TA	L	1	16	85	10	125	0.5	6	7.5	58	52	23	1	1
TACU105*016#TA	U	1	16	85	10	125	0.5	8	5	84	75	33	1	1
TACL225*016#TA	L	2.2	16	85	10	125	0.5	10	7.5	58	52	23	1	1
TACR106*016#TA	R	10	16	85	10	125	1.6	10	5	95	85	38	2	1
20 Volt @ 85°C														
TACK224*020#TA	K	0.22	20	85	13	125	0.5	6	20	27	25	11	1	1
TACR335*020#TA	R	3.3	20	85	13	125	0.7	8	5	95	85	38	1	1
TACR475*020#TA	R	4.7	20	85	13	125	0.9	8	5	95	85	38	1	1
25 Volt @ 85°C														
TACR105*025#TA	R	1	25	85	17	125	0.5	8	5	95	85	38	1	1

Moisture Sensitivity Level (MSL) is defined according to J-STD-020.

All technical data relates to an ambient temperature of +25°C. Capacitance and DF are measured at 120Hz, 0.5V RMS with a maximum DC bias of 2.2 volts.

DCL is measured at rated voltage after 5 minutes.

For typical weight and composition see page 274.

NOTE: AVX reserves the right to supply higher voltage ratings or tighter tolerance part in the same case size, to the same reliability standards.

QUALIFICATION TABLE – CATEGORY 1

TEST	TAC series (Temperature range -55°C to +125°C)									
	Condition			Characteristics						
Endurance	Apply rated voltage (Ur) at 85°C and / or category voltage (Uc) at 125°C for 2000 hours through a circuit impedance of $\leq 0.1\Omega/V$. Stabilize at room temperature for 1-2 hours before measuring.			Visual examination	no visible damage					
				DCL	1.25 x initial limit					
				$\Delta C/C$	within $\pm 10\%$ of initial value					
				DF	1.5 x initial limit					
				ESR	1.5 x initial limit					
Humidity	Store at 40°C and 90-95% relative humidity for 1344 hours, with no applied voltage. Stabilize at room temperature and humidity for 1-2 hours before measuring.			Visual examination	no visible damage					
				DCL	initial limit					
				$\Delta C/C$	within $\pm 5\%$ of initial value					
				DF	1.2 x initial limit					
				ESR	1.2 x initial limit					
Temperature Stability	Step	Temperature°C	Duration(min)		+20°C	-55°C	+20°C	+85°C	+125°C	+20°C
	1	+20	15							
	2	-55	15	DCL	IL*	n/a	IL*	10 x IL*	12.5 x IL*	IL*
	3	+20	15	$\Delta C/C$	n/a	+0/-10%	$\pm 5\%$	+10/-0%	+15/-0%	$\pm 5\%$
	4	+85	15	DF	IL*	1.5 x IL*	IL*	1.5 x IL*	2 x IL*	IL*
	5	+125	15							
	6	+20	15	ESR	IL*	1.25 x IL*	IL*	1.25 x IL*	2 x IL*	IL*
Surge Voltage	Apply 1.3x rated voltage (Ur) at 85°C for 1000 cycles of duration 6 min (30 sec charge, 5 min 30 sec discharge) through a charge / discharge resistance of 1000 Ω			Visual examination	no visible damage					
				DCL	initial limit					
				$\Delta C/C$	within $\pm 10\%$ of initial value					
				DF	initial limit					
				ESR	initial limit					

*Initial Limit

QUALIFICATION TABLE – CATEGORY 2

TEST	TAC series (Temperature range -55°C to +125°C)									
	Condition			Characteristics						
Endurance	Apply rated voltage (Ur) at 85°C and / or category voltage (Uc) at 125°C for 2000 hours through a circuit impedance of $\leq 0.1\Omega/V$. Stabilize at room temperature for 1-2 hours before measuring.			Visual examination	no visible damage					
				DCL	1.25 x initial limit					
				$\Delta C/C$	within $\pm 15\%$ of initial value					
				DF	1.5 x initial limit					
				ESR	1.5 x initial limit					
Humidity	Store at 40°C and 90-95% relative humidity for 1344 hours, with no applied voltage. Stabilize at room temperature and humidity for 1-2 hours before measuring.			Visual examination	no visible damage					
				DCL	initial limit					
				$\Delta C/C$	within $\pm 10\%$ of initial value					
				DF	1.2 x initial limit					
				ESR	1.2 x initial limit					
Temperature Stability	Step	Temperature°C	Duration(min)		+20°C	-55°C	+20°C	+85°C	+125°C	+20°C
	1	+20	15							
	2	-55	15	DCL	IL*	n/a	IL*	10 x IL*	12.5 x IL*	IL*
	3	+20	15	$\Delta C/C$	n/a	+0/-15%	$\pm 5\%$	+15/-0%	+20/-0%	$\pm 5\%$
	4	+85	15	DF	IL*	1.5 x IL*	IL*	1.5 x IL*	2 x IL*	IL*
	5	+125	15							
	6	+20	15	ESR	IL*	1.25 x IL*	IL*	1.25 x IL*	2 x IL*	IL*
Surge Voltage	Apply 1.3x rated voltage (Ur) at 85°C for 1000 cycles of duration 6 min (30 sec charge, 5 min 30 sec discharge) through a charge / discharge resistance of 1000 Ω			Visual examination	no visible damage					
				DCL	1.5 x initial limit					
				$\Delta C/C$	within $\pm 15\%$ of initial value					
				DF	1.5 x initial limit					
				ESR	1.5 x initial limit					

*Initial Limit

QUALIFICATION TABLE – CATEGORY 3

TEST	TAC series (Temperature range -55°C to +125°C)										
	Condition			Characteristics							
Endurance	Apply rated voltage (Ur) at 85°C and / or category voltage (Uc) at 125°C for 2000 hours through a circuit impedance of $\leq 0.1\Omega/V$. Stabilize at room temperature for 1-2 hours before measuring.			Visual examination	no visible damage						
				DCL	1.25 x initial limit						
				$\Delta C/C$	within $\pm 30\%$ of initial value						
				DF	1.5 x initial limit						
				ESR	1.5 x initial limit						
Humidity	Store at 40°C and 90-95% relative humidity for 1344 hours, with no applied voltage. Stabilize at room temperature and humidity for 1-2 hours before measuring.			Visual examination	no visible damage						
				DCL	2 x initial limit						
				$\Delta C/C$	within $\pm 30\%$ of initial value						
				DF	1.5 x initial limit						
				ESR	1.25 x initial limit						
Temperature Stability	Step	Temperature°C	Duration(min)		+20°C	-55°C	+20°C	+85°C	+125°C	+20°C	
	1	+20	15								
	2	-55	15	DCL	IL*	n/a	IL*	10 x IL*	12.5 x IL*	IL*	
	3	+20	15	$\Delta C/C$	n/a	+0/-25%	$\pm 5\%$	+20/-0%	+25/-0%	$\pm 20\%$	
	4	+85	15	DF	IL*	1.5 x IL*	IL*	1.5 x IL*	2 x IL*	1.5 x IL*	
	5	+125	15								
	6	+20	15	ESR	IL*	1.25 x IL*	IL*	1.25 x IL*	2 x IL*	1.5 x IL*	
Surge Voltage	Apply 1.3x rated voltage (Ur) at 85°C for 1000 cycles of duration 6 min (30 sec charge, 5 min 30 sec discharge) through a charge / discharge resistance of 1000 Ω			Visual examination	no visible damage						
				DCL	2 x initial limit						
				$\Delta C/C$	within $\pm 30\%$ of initial value						
				DF	2 x initial limit						
				ESR	2 x initial limit						

*Initial Limit

TAC Series

Standard and Low Profile Tantalum Microchip Capacitors

SOLID ELECTROLYTIC CAPACITOR ROADMAP

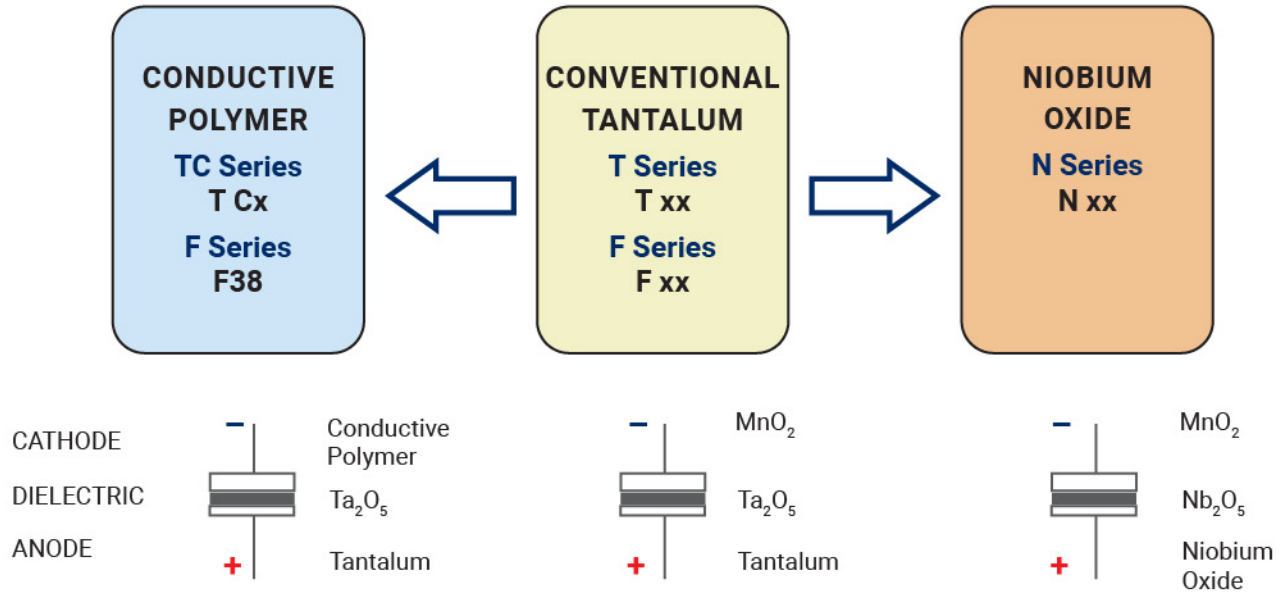

FIVE CAPACITOR CONSTRUCTION STYLES

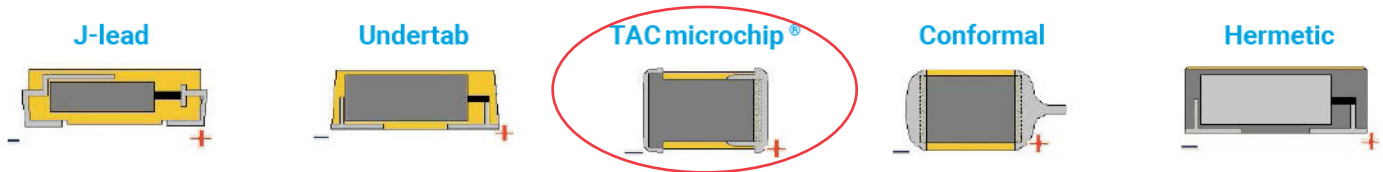

SERIES LINE UP : Conventional SMD MnO₂

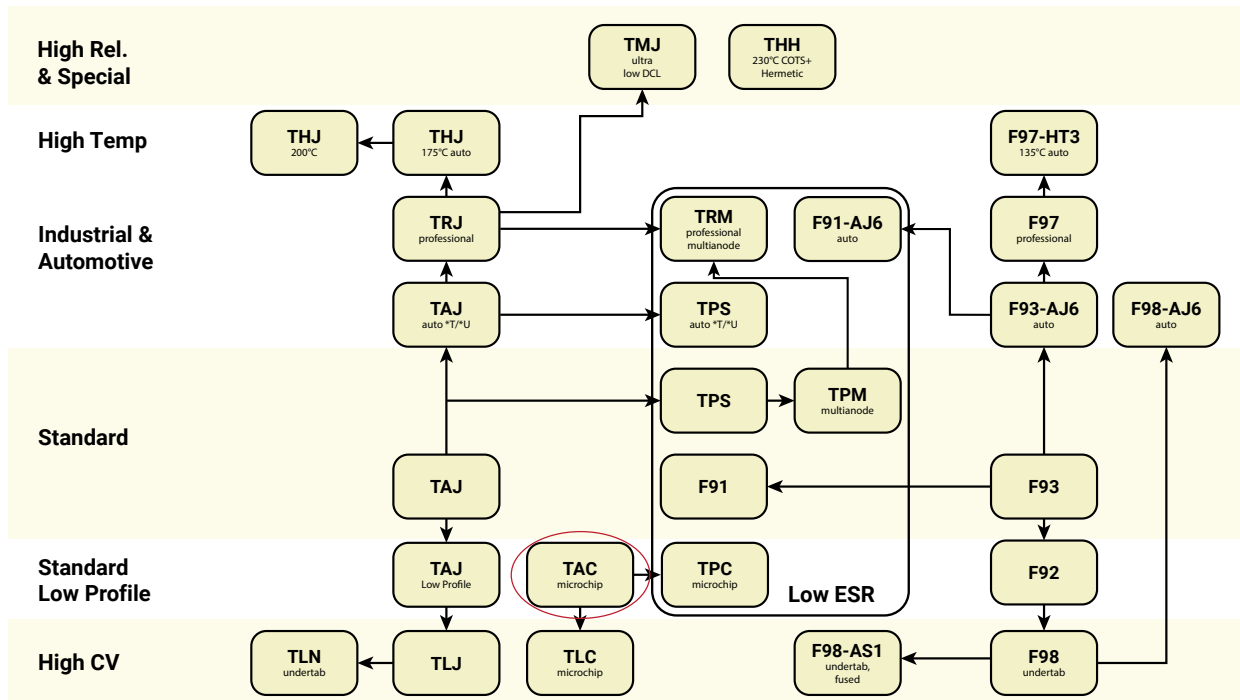

TLC Series

Tantalum Solid Electrolytic Chip Capacitors Consumer Series

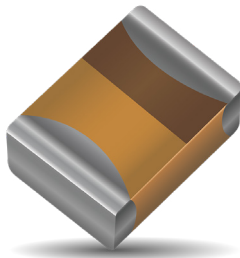

FEATURES

- High Capacitance vs. Voltage Ratio
- Super High Volumetric Efficiency
- 100% Surge Current Tested
- CV Range: 0.47-220µF / 2-35V
- 12 Case Sizes Available
- Consumer Applications (Portable Hand-held Electronics, Cellular Phones, Digital Equipment etc.)



LEAD-FREE

LEAD-FREE COMPATIBLE COMPONENT



APPLICATIONS

- Consumer Portable Applications with Space Limitations

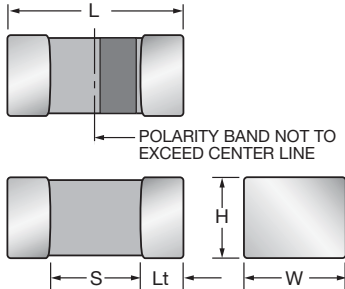

CASE DIMENSIONS:

millimeters (inches)

Code	EIA Code	EIA Metric	L+0.20 (0.008) -0.00 (0.000)	W+0.15 (0.006) -0.00 (0.000)	H+0.15 (0.006) -0.00 (0.000)	Termination Spacing (S)	Minimum Termination Length (Lt)
D	1206	3216-06	3.20 ± 0.20 (0.126 ± 0.008)	1.60 ± 0.20 (0.063 ± 0.008)	0.60 (0.024) max	1.80 (0.071) min	0.15 (0.006)
E*	0201	0603-03	0.60 ± 0.12 (0.024 ± 0.005)	0.33 ± 0.02 (0.013 ± 0.001)	0.33 ± 0.02 (0.013 ± 0.001)	0.20 (0.008) min	0.10 (0.004)
H	0805	2012-10	2.00 (0.079)	1.35 (0.053)	1.00 (0.039) max	0.70 (0.028) min	0.15 (0.006)
J	0603	1608-08	1.60 (0.063)	0.85 (0.033)	0.75 (0.030) max	0.55 (0.022) min	0.15 (0.006)
K	0402	1005-07	1.00 (0.039)	0.50 ^{+0.20} _{-0.10} (0.020 ^{+0.008} _{-0.004})	0.50 ^{+0.20} _{-0.10} (0.020 ^{+0.008} _{-0.004})	0.40 (0.016) min	0.10 (0.004)
L	0603	1608-10	1.60 (0.063)	0.85 (0.033)	0.85 (0.033)	0.55 (0.022) min	0.15 (0.006)
M	0803	2008-10	2.00 (0.079)	0.85 (0.033)	0.85 (0.033)	0.70 (0.028) min	0.15 (0.006)
R	0805	2012-15	2.00 (0.079)	1.35 (0.053)	1.35 (0.053)	0.70 (0.028) min	0.15 (0.006)
T	1210	3528-12	3.50 ± 0.20 (0.138 ± 0.008)	2.80 ^{+0.20} _{-0.10} (0.110 ^{+0.008} _{-0.004})	1.20 (0.047) max	2.00 (0.079) min	0.15 (0.006)
U	0805	2012-06	2.00 (0.079)	1.35 (0.053)	0.60 (0.024) max	0.70 (0.028) min	0.15 (0.006)
V	1206	3216-08	3.20 ± 0.20 (0.126 ± 0.008)	1.60 ± 0.20 (0.063 ± 0.008)	0.75 (0.030) max	1.80 (0.071) min	0.15 (0.006)
Z	0602	1605-07	1.60 (0.063)	0.50 ^{+0.20} _{-0.10} (0.020 ^{+0.008} _{-0.004})	0.50 ^{+0.20} _{-0.10} (0.020 ^{+0.008} _{-0.004})	0.55 (0.022) min	0.15 (0.006)

*Please contact AVX, availability upon request

MARKING

D, H, J, K, L, M, R, T, U, V, Z CASE

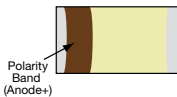

E CASE

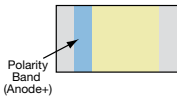

HOW TO ORDER

TLC	L	226	M	006	R	TA	4000
Type	Case Size See table above	Capacitance Code pF code: 1st two digits represent significant figures, 3rd digit represents multiplier (number of zeros to follow)	Tolerance M = ±20%	Rated DC Voltage 002=2Vdc 003=3Vdc 004=4Vdc 006=6.3Vdc 008=8Vdc 010=10Vdc 016=16Vdc 020=20Vdc 025=25Vdc 035=35Vdc	Packaging R, P = 7" Standard Tin Termination Plastic Tape X, Q = 4 1/4" Standard Tin Termination Plastic Tape A, M = 7" Gold Termination Plastic Tape F, N = 4 1/4" Gold Termination Plastic Tape H = Chip Tray (waffle) Only case E	Standard Suffix OR	ESR in mΩ

TLC Series

Tantalum Solid Electrolytic Chip Capacitors Consumer Series



TECHNICAL SPECIFICATIONS

Technical Data:	All technical data relate to an ambient temperature of +25°C										
Capacitance Range:	0.47 μ F to 220 μ F										
Capacitance Tolerance:	$\pm 20\%$										
Rated Voltage (V_R)	-55°C \leq +40°C:	2	3	4	6.3	8	10	16	20	25	35
Category Voltage (V_C)	at 85°C:	1	1.5	2	3.2	4	5	8	10	12.5	17.5
Category Voltage (V_C)	at 125°C:	0.4	0.6	0.8	1.3	1.6	2	3.2	4	5	7
Temperature Range:	-55°C to +125°C with category voltage										
Reliability:	0.2% per 1000 hours at 85°C, 0.5x V_R with 0.1 Ω /V series impedance with 60% confidence level										

CAPACITANCE AND RATED VOLTAGE RANGE (LETTER DENOTES CASE SIZE)

Capacitance		Voltage Rating DC (V_R) to 40°C									
μ F	Code	2.0V	3.0V	4.0V	6.3V	8V	10V	16V	20V	25V	35V
0.47	474				E*			K			
1.0	105				E*			K		L	R
2.2	225						K		H		
3.3	335							L			
4.7	475			K	K/U		J				
6.8	685		K	K			U				
10	106		K	J/K/Z	J/K/Z		U	V	R		
15	156	K		K			H/L				
22	226	J	J	U	L/U		L/M				
33	336			L/U	H/L L(4000)/U/V	L	H				
47	476	L	L/R	H/L	H/L/R/V	D	H/R				
68	686			R	R						
100	107			R	R/T		T				
150	157										
220	227			T							

Released ratings, (ESR ratings in mOhms in parentheses)

*Please contact AVX, availability upon request

Note: Voltage ratings are minimum values. AVX reserves the right to supply higher voltage ratings in the same case size, to the same reliability standards.

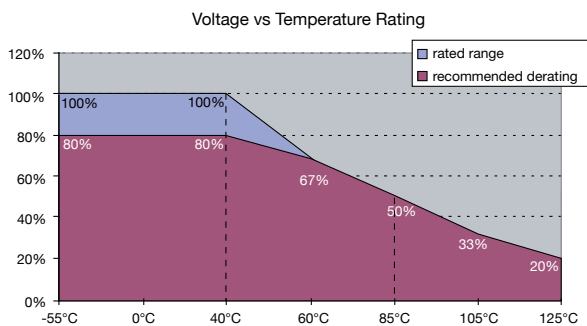

TLC Series

Tantalum Solid Electrolytic Chip Capacitors Consumer Series



RATINGS & PART NUMBER REFERENCE

AVX Part No.	Case Size	Capacitance (µF)	Rated Voltage (V)	Rated Temperature (°C)	Category Voltage (V)	Category Temperature (°C)	DCL Max. (µA)	ESR Max. @100kHz (Ω)	100kHz R MS Current (mA)			MSL
									25°C	85°C	125°C	
2 Volt @ 40°C												
TLCK156M002#TA	K	15	2	40	0.4	125	0.5	15	32	28	13	3
TLCJ226M002#TA	J	22	2	40	0.4	125	0.5	7.5	52	46	21	3
TLCL476M002#TA	L	47	2	40	0.4	125	0.9	7.5	58	52	23	3
3 Volt @ 40°C												
TLCK685M003#TA	K	6.8	3	40	0.6	125	0.5	15	32	28	13	3
TLCK106M003#TA	K	10	3	40	0.6	125	0.5	15	32	28	13	3
TLCJ226M003#TA	J	22	3	40	0.6	125	0.7	7.5	52	46	21	3
TLCL476M003#TA	L	47	3	40	0.6	125	1.4	7.5	58	52	23	3
TLCR476M003#TA	R	47	3	40	0.6	125	3.0	7.5	77	70	31	3
4 Volt @ 40°C												
TLCK475M004#TA	K	4.7	4	40	0.8	125	0.5	15	32	28	13	3
TLCK685M004#TA	K	6.8	4	40	0.8	125	0.5	15	32	28	13	3
TLCJ106M004#TA	J	10	4	40	0.8	125	0.5	7.5	52	46	21	3
TLCK106M004#TA	K	10	4	40	0.8	125	0.5	15	32	28	13	3
TL CZ106M004#TA	Z	10	4	40	0.8	125	0.5	15	37	33	15	3
TLCK156M004#TA	K	15	4	40	0.8	125	3.0	15	32	28	13	3
TL CU226M004#TA	U	22	4	40	0.8	125	0.9	12	54	49	22	3
TLCL336M004#TA	L	33	4	40	0.8	125	1.3	7.5	58	52	23	3
TL CU336M004#TA	U	33	4	40	0.8	125	2.6	9	62	56	25	3
TLCH476M004#TA	H	47	4	40	0.8	125	1.9	5	89	80	36	3
TLCL476M004#TA	L	47	4	40	0.8	125	1.9	7.5	58	52	23	3
TL CR686M004#TA	R	68	4	40	0.8	125	2.7	5	95	85	38	3
TL CR107M004#TA	R	100	4	40	0.8	125	4.0	5	95	85	38	3
TLCT227M004#TA	T	220	4	40	0.8	125	8.8	1	200	180	80	3
6.3 Volt @ 40°C												
TLCE474M006HTA*	E	0.47	6.3	40	1.3	125	1.0	60	13	12	5	3
TLCE105M006HTA*	E	1	6.3	40	1.3	125	1.0	60	13	12	5	3
TLCK475M006#TA	K	4.7	6.3	40	1.3	125	0.5	15	32	28	13	3
TL CU475M006#TA	U	4.7	6.3	40	1.3	125	0.5	5	84	75	33	3
TLCJ106M006#TA	J	10	6.3	40	1.3	125	0.6	7.5	52	46	21	3
TLCK106M006#TA	K	10	6.3	40	1.3	125	3.1	15	32	28	13	3
TL CZ106M006#TA	Z	10	6.3	40	1.3	125	0.6	15	37	33	15	3
TLCL226M006#TA	L	22	6.3	40	1.3	125	1.4	7.5	58	52	23	3
TL CU226M006#TA	U	22	6.3	40	1.3	125	2.8	12	54	49	22	3
TLCH336M006#TA	H	33	6.3	40	1.3	125	2.0	5	89	80	36	3
TLCL336M006#TA	L	33	6.3	40	1.3	125	2.1	7.5	58	52	23	3
TLCL336M006#4000	L	33	6.3	40	1.3	125	2.1	4	79	71	32	3
TL CU336M006#TA	U	33	6.3	40	1.3	125	10.4	7.5	68	61	27	3
TL CV336M006#TA	V	33	6.3	40	1.3	125	4.2	5	84	75	33	3
TLCH476M006#TA	H	47	6.3	40	1.3	125	3.0	5	89	80	36	3
TLCL476M006#TA	L	47	6.3	40	1.3	125	29.6	10	50	45	20	3
TL CR476M006#TA	R	47	6.3	40	1.3	125	6.0	5	95	85	38	3
TL CV476M006#TA	V	47	6.3	40	1.3	125	6.0	15	48	43	19	3
TL CR686M006#TA	R	68	6.3	40	1.3	125	4.3	5	95	85	38	3
TL CR107M006#TA	R	100	6.3	40	1.3	125	6.0	5	95	85	38	3
TLCT107M006#TA	T	100	6.3	40	1.3	125	31.5	15	52	46	21	3
8 Volt @ 40°C												
TLCL336M008#TA	L	33	8	40	1.6	125	26.4	10	50	45	20	3
TL CD476M008#TA	D	47	8	40	1.6	125	18.8	7	71	64	28	3
10 Volt @ 40°C												
TLCK225M010#TA	K	2.2	10	40	2	125	0.5	15	32	28	13	3
TL CJ475M010#TA	J	4.7	10	40	2	125	0.5	10	45	40	18	3
TL CU685M010#TA	U	6.8	10	40	2	125	0.7	5	84	75	33	3
TL CU106M010#TA	U	10	10	40	2	125	1.0	5	84	75	33	3
TL CH156M010#TA	H	15	10	40	2	125	1.5	5	58	52	23	3
TL CL156M010#TA	L	15	10	40	2	125	1.5	7.5	89	80	36	3
TL CL226M010#TA	L	22	10	40	2	125	11	10	50	45	20	3
TL CM226M010#TA	M	22	10	40	2	125	2.2	7.5	63	57	25	3
TL CH336M010#TA	H	33	10	40	2	125	3.3	5	89	80	36	3
TL CH476M010#TA	H	47	10	40	2	125	23.5	7.5	73	66	29	3
TL CR476M010#TA	R	47	10	40	2	125	4.7	5	95	85	38	3
TLCT107M010#TA	T	100	10	40	2	125	10	1	200	180	80	3
16 Volt @ 40°C												
TLCK474M016#TA	K	0.47	16	40	3.2	125	0.5	15	32	28	13	3
TLCK105M016#TA	K	1	16	40	3.2	125	0.8	15	32	28	13	3
TLCL335M016#TA	L	3.3	16	40	3.2	125	0.5	7.5	58	52	23	3
TL CV106M016#TA	V	10	16	40	3.2	125	1.6	2	132	119	53	3

TLC Series

Tantalum Solid Electrolytic Chip Capacitors Consumer Series



RATINGS & PART NUMBER REFERENCE

AVX Part No.	Case Size	Capacitance (µF)	Rated Voltage (V)	Rated Temperature (°C)	Category Voltage (V)	Category Temperature (°C)	DCL Max. (µA)	ESR Max. @100kHz (Ω)	100kHz RMS Current (mA)			MSL
									25°C	85°C	125°C	
20 Volt @ 40°C												
TLCH225M020#TA	H	2.2	20	40	4	125	0.5	7.5	89	80	36	3
TLCR106M020#TA	R	10	20	40	4	125	0.6	5	95	85	38	3
25 Volt @ 40°C												
TLCL105M025#TA	L	1.0	25	40	5	125	0.5	7.5	58	85	23	3
35 Volt @ 40°C												
TLCR105M035#TA	R	1.0	35	40	7	125	0.5	5	95	85	38	3

*Please contact AVX, availability upon request

Moisture Sensitivity Level (MSL) is defined according to J-STD-020.

All technical data relates to an ambient temperature of +25°C. Capacitance and DF are measured at 120Hz, 0.5V RMS with a maximum DC bias of 2.2 volts.

DCL is measured at rated voltage after 5 minutes.

DCL allowed to move up to 2.00 times the limit post mounting.

For typical weight and composition see page 274.

NOTE: AVX reserves the right to supply higher voltage ratings or tighter tolerance part in the same case size, to the same reliability standards.

QUALIFICATION TABLE

TEST	TLC series (Temperature range -55°C to +125°C)												
	Condition				Characteristics								
Endurance	Apply rated voltage (Ur) at 40°C and / or category voltage (Uc) at 85°C for 2000 hours through a circuit impedance of ≤0.1Ω/V. Stabilize at room temperature for 1-2 hours before measuring.				Visual examination	no visible damage							
					DCL	1.25 x initial limit							
					ΔC/C	within ±30% of initial value							
					ESR	1.5 x initial limit							
Humidity	Store at 40°C and 90-95% relative humidity for 56 days, with no applied voltage. Stabilize at room temperature and humidity for 1-2 hours before measuring.				Visual examination	no visible damage							
					DCL	2 x initial limit							
					ΔC/C	±30% of initial value							
					ESR	1.25 x initial limit							
Temperature Stability	Step	Temperature°C	Duration (min)	Voltage Applied									
	1	+20	15	N/A									
	2	-55	15	N/A									
	3	+20	15	N/A	DCL	IL*	n/a	IL*	1.25 x IL*	1.25 x IL*	1.25 x IL*	1.25 x IL*	IL*
	4	+40	15	V _R	ΔC/C	n/a	+0/-25%	±5%	+10/-0%	+10/-0%	+20/-0%	+25/-0%	+20/-10%
	5	+60	15	0.66 x V _R	ESR	IL*	n/a	1.25 x IL*	1.25 x IL*	1.25 x IL*	1.25 x IL*	1.25 x IL*	1.25 x IL*
	6	+85	15	0.50 x V _R									
	7	+125	15	0.20 x V _R									
8	+20	15	15	N/A									
Surge Voltage	Apply 1.3x rated voltage (Ur) at 40°C for 1000 cycles of duration 6 min (30 sec charge, 5 min 30 sec discharge) through a charge / discharge resistance of 1000Ω				Visual examination	no visible damage							
					DCL	2 x initial limit							
					ΔC/C	within ±30% of initial value							
					ESR	1.25 x initial limit							

*Initial Limit

TLC Series

Tantalum Solid Electrolytic Chip Capacitors Consumer Series

AVX SOLID ELECTROLYTIC CAPACITOR ROADMAP

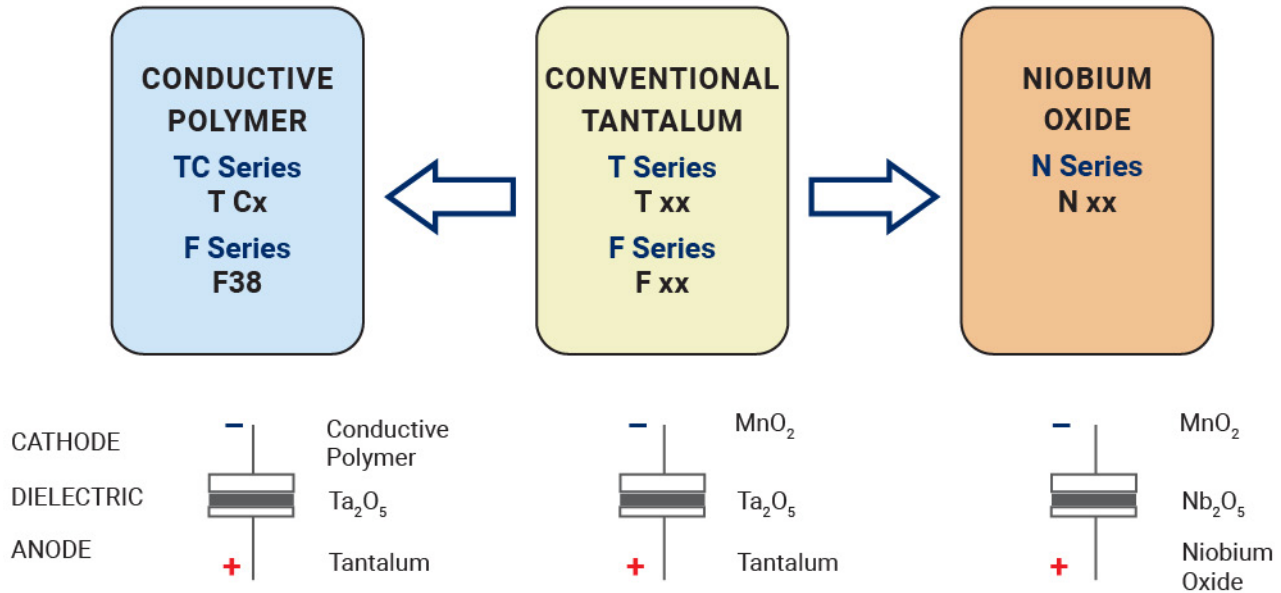

FIVE CAPACITOR CONSTRUCTION STYLES

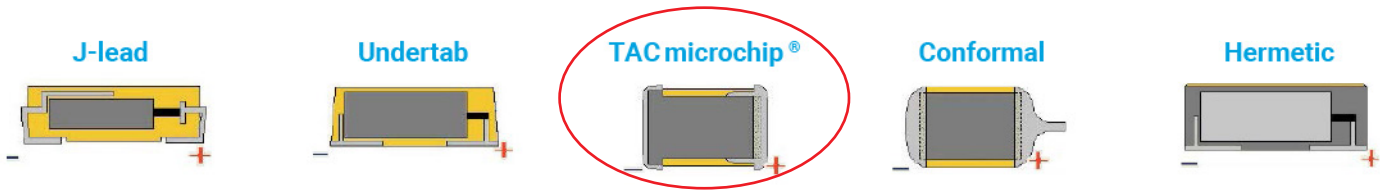

SERIES LINE UP : CONVENTIONAL SMD MnO₂

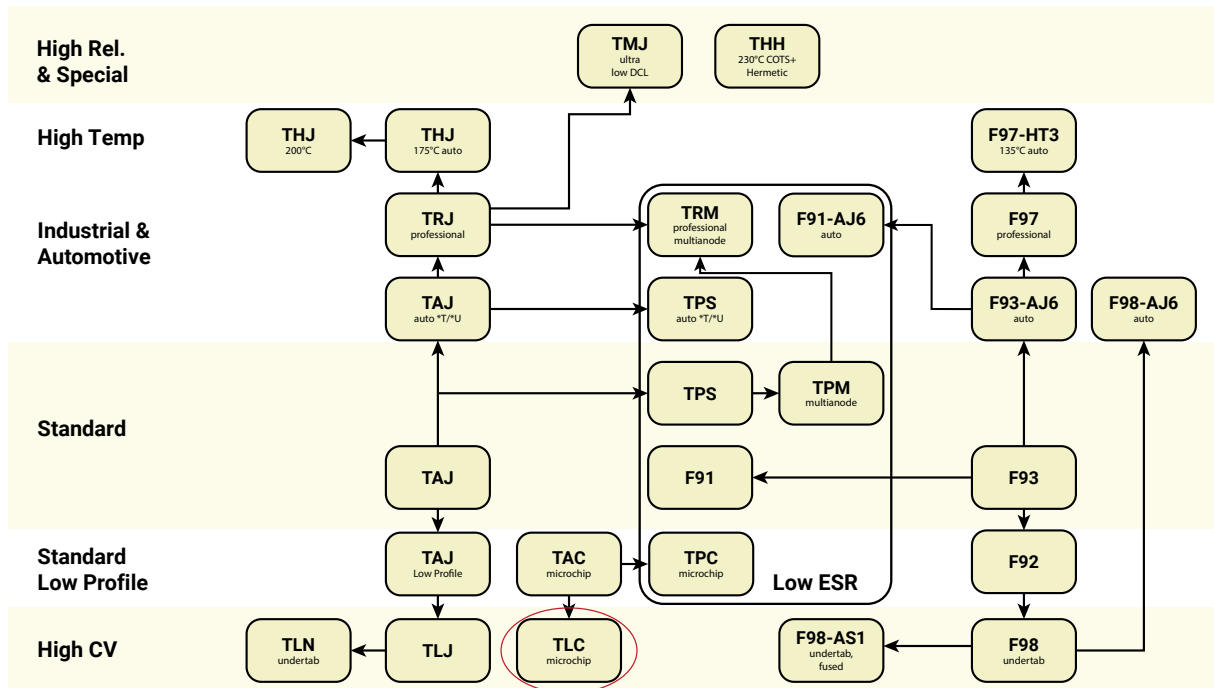

TPC Series

Low ESR TACmicrochip®

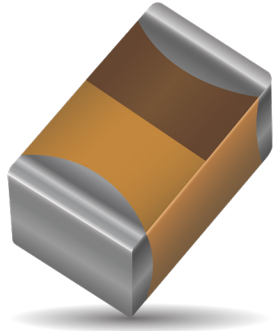

FEATURES

- Low ESR TACmicrochip® Capacitor
- Smallest and Low Profile Tantalum
- 100% Surge Current Tested
- CV Range: 1.0-100µF / 3-25V
- 4 Case Sizes Available
- Power Supply Applications



LEAD-FREE

LEAD-FREE COMPATIBLE COMPONENT



APPLICATIONS

- Portable Controller with Elevated Power Requirements

CASE DIMENSIONS:

millimeters (inches)

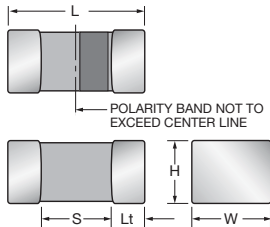

Code	EIA Code	EIA Metric	L+0.20 (0.008) -0.00 (0.000)	W+0.15 (0.006) -0.00 (0.000)	H+0.15 (0.006) -0.00 (0.000)	Termination Spacing (S)	Minimum Termination Length (Lt)
H	0805	2012-10	2.00 (0.079)	1.35 (0.053)	1.00 (0.039) max	0.70 (0.028) min	0.15 (0.006)
K	0402	1005-07	1.00 (0.039)	0.50 ^{+0.20} _{-0.10} (0.020 ^{+0.008} _{-0.004})	0.50 ^{+0.20} _{-0.10} (0.020 ^{+0.008} _{-0.004})	0.40 (0.016) min	0.10 (0.004)
L	0603	1608-10	1.60 (0.063)	0.85 (0.033)	0.85 (0.033)	0.55 (0.022) min	0.15 (0.006)
R	0805	2012-15	2.00 (0.079)	1.35 (0.053)	1.35 (0.053)	0.70 (0.028) min	0.15 (0.006)

MARKING

H, K, L, R CASE

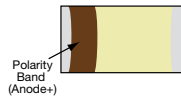

HOW TO ORDER

TPC	R	106	*	010	R	1800
Type TACmicrochip®	Case Size See table above	Capacitance Code pF code: 1st two digits represent significant figures, 3rd digit represents multiplier (number of zeros to follow)	Tolerance K=±10% M=±20%	Rated DC Voltage 003=3Vdc 004=4Vdc 006=6.3Vdc 010=10Vdc 016=16Vdc 020=20Vdc 025=25Vdc	Packaging R, P = 7" Standard Tin Termination Plastic Tape X, Q = 4¼" Standard Tin Termination Plastic Tape A, M = 7" Gold Termination Plastic Tape F, N = 4¼" Gold Termination Plastic Tape	ESR in mΩ

TECHNICAL SPECIFICATIONS

Technical Data:	All technical data relate to an ambient temperature of +25°C							
Capacitance Range:	1.0 µF to 100 µF							
Capacitance Tolerance:	±10%; ±20%							
Leakage Current DCL:	0.01CV or 0.5µA whichever is the greater							
Rated Voltage (V _R)	≤ +85°C:	3	4	6.3	10	16	20	25
Category Voltage (V _C)	≤ +125°C:	2	2.7	4	7	10	13	17
Surge Voltage (V _S)	≤ +85°C:	3.9	5.2	8	13	20	26	32
Surge Voltage (V _S)	≤ +125°C:	2.6	3.2	5	8	12	16	20
Temperature Range:	-55°C to +125°C							
Reliability:	1% per 1000 hours at 85°C, V _R with 0.1Ω/V series impedance, 60% confidence level							
Termination Finish:	Tin Plating over Nickel (standard), Gold Plating over Nickel option available upon request							

CAPACITANCE AND RATED VOLTAGE RANGE (LETTER DENOTES CASE SIZE)

Capacitance		Voltage Rating DC (V _R) at 85°C						
µF	Code	3.0V	4.0V	6.3V	10V	16V	20V	25V
1.0	105				L(5000)			R(3000)
1.5	155							
2.2	225			K(8000)/L(5000)	L(5000)	L(5000)		
3.3	335				L(5000)			
4.7	475	K(8000)			L(5000)		R(2000)	
6.8	685							
10	106			L(4000)	H(2500) L(4000),R(1800)	R(1800)		
15	156			R(1800)	R(1500)			
22	226		L(5000)/R(1800)	R(1500)	R(1500)			
33	336	R(1800)	H(1500)/R(1500)		R(1500)			
47	476	R(1500)		R(1800)				
68	686							
100	107		R(1000)					

Codes shown are examples of ESR values offered on certain CV and case size. Other codes and ESR values available upon request.

Released ratings, (ESR ratings in mOhms in parentheses)

Note: Voltage ratings are minimum values. AVX reserves the right to supply higher voltage ratings in the same case size, to the same reliability standards.

RATINGS & PART NUMBER REFERENCE

AVX Part No.	Case Size	Capacitance (µF)	Rated Voltage (V)	Rated Temperature (°C)	Category Voltage (V)	Category Temperature (°C)	DCL Max. (µA)	DF Max. (%)	ESR Max. @ 100kHz (mΩ)	100kHz RMS Current (A)			Product Category	MSL
										25°C	85°C	125°C		
3 Volt @ 85°C														
TPCK475*003#8000	K	4.7	3	85	2	125	0.5	12	8000	0.043	0.039	0.017	3	1
TPCR336*003#1800	R	33	3	85	2	125	1.0	10	1800	0.158	0.142	0.063	2	1
TPCR476*003#1500	R	47	3	85	2	125	1.5	10	1500	0.173	0.156	0.069	3	1
4 Volt @ 85°C														
TPCL226*004#5000	L	22	4	85	2.7	125	0.9	6	5000	0.071	0.064	0.028	3	1
TPCR226*004#1800	R	22	4	85	2.7	125	0.9	8	1800	0.158	0.142	0.063	1	1
TPCH336*004#1500	H	33	4	85	2.7	125	1.3	14	1500	0.163	0.147	0.065	3	1
TPCR336*004#1500	R	33	4	85	2.7	125	1.3	10	1500	0.173	0.156	0.069	2	1
TPCR107*004#1000	R	100	4	85	2.7	125	4.0	30	1000	0.212	0.191	0.085	3	1
6.3 Volt @ 85°C														
TPCK225*006#8000	K	2.2	6.3	85	4	125	0.5	8	8000	0.043	0.039	0.017	3	1
TPCL225*006#5000	L	2.2	6.3	85	4	125	0.5	6	5000	0.071	0.064	0.028	1	1
TPCL106*006#4000	L	10	6.3	85	4	125	0.6	10	4000	0.079	0.071	0.032	3	1
TPCR156*006#1800	R	15	6.3	85	4	125	0.9	8	1800	0.158	0.142	0.063	1	1
TPCR226*006#1500	R	22	6.3	85	4	125	1.4	10	1500	0.173	0.156	0.069	1	1
TPCR476*006#1800	R	47	6.3	85	4	125	3.0	20	1800	0.158	0.142	0.063	3	1
10 Volt @ 85°C														
TPCL105*010#5000	L	1.0	10	85	7	125	0.5	6	5000	0.071	0.064	0.028	1	1
TPCL225*010#5000	L	2.2	10	85	7	125	0.5	6	5000	0.071	0.064	0.028	1	1
TPCL335*010#5000	L	3.3	10	85	7	125	0.5	8	5000	0.071	0.064	0.028	2	1
TPCL475*010#5000	L	4.7	10	85	7	125	0.5	10	5000	0.071	0.064	0.028	2	1
TPCH106*010#2500	H	10	10	85	7	125	1.0	8	2500	0.126	0.113	0.050	2	1
TPCL106*010#4000	L	10	10	85	7	125	1.0	20	4000	0.079	0.071	0.032	3	1
TPCR106*010#1800	R	10	10	85	7	125	1.0	8	1800	0.158	0.142	0.063	1	1
TPCR156*010#1500	R	15	10	85	7	125	1.5	10	1500	0.173	0.156	0.069	1	1
TPCR226*010#1500	R	22	10	85	7	125	2.2	14	1500	0.173	0.156	0.069	2	1
TPCR336*010#1500	R	33	10	85	7	125	3.3	20	1500	0.173	0.156	0.069	3	1
16 Volt @ 85°C														
TPCL225*016#5000	L	2.2	16	85	10	125	0.5	10	5000	0.071	0.064	0.028	1	1
TPCR106*016#1800	R	10	16	85	10	125	1.6	10	1800	0.158	0.142	0.063	2	1
20 Volt @ 85°C														
TPCR475*020#2000	R	4.7	20	85	13	125	0.9	8	2000	0.150	0.135	0.060	1	1
25 Volt @ 85°C														
TPCR105*025#3000	R	1.0	25	85	17	125	0.5	8	3000	0.122	0.110	0.049	1	1

Moisture Sensitivity Level (MSL) is defined according to J-STD-020.

All technical data relates to an ambient temperature of +25°C. Capacitance and DF are measured at 120Hz, 0.5V RMS with a maximum DC bias of 2.2 volts.

DCL is measured at rated voltage after 5 minutes.

For typical weight and composition see page 274.

NOTE: AVX reserves the right to supply higher voltage ratings or tighter tolerance part in the same case size, to the same reliability standards.

QUALIFICATION TABLE – CATEGORY 1

TEST	TPC series (Temperature range -55°C to +125°C)									
	Condition			Characteristics						
Endurance	Apply rated voltage (Ur) at 85°C and / or category voltage (Uc) at 125°C for 2000 hours through a circuit impedance of $\leq 0.1\Omega/V$. Stabilize at room temperature for 1-2 hours before measuring.			Visual examination	no visible damage					
				DCL	1.25 x initial limit					
				$\Delta C/C$	within $\pm 10\%$ of initial value					
				DF	1.5 x initial limit					
				ESR	1.5 x initial limit					
Humidity	Store at 40°C and 90-95% relative humidity for 1344 hours, with no applied voltage. Stabilize at room temperature and humidity for 1-2 hours before measuring.			Visual examination	no visible damage					
				DCL	initial limit					
				$\Delta C/C$	within $\pm 5\%$ of initial value					
				DF	1.2 x initial limit					
				ESR	1.2 x initial limit					
Temperature Stability	Step	Temperature°C	Duration(min)		+20°C	-55°C	+20°C	+85°C	+125°C	+20°C
	1	+20	15	DCL	IL*	n/a	IL*	10 x IL*	12.5 x IL*	IL*
	2	-55	15		$\Delta C/C$	n/a	+0/-10%	$\pm 5\%$	+10/-0%	+15/-0%
	3	+20	15	DF	IL*	1.5 x IL*	IL*	1.5 x IL*	2 x IL*	IL*
	4	+85	15	ESR	IL*	1.25 x IL*	IL*	1.25 x IL*	2 x IL*	IL*
	5	+125	15							
6	+20	15								
Surge Voltage	Apply 1.3x rated voltage (Ur) at 85°C for 1000 cycles of duration 6 min (30 sec charge, 5 min 30 sec discharge) through a charge / discharge resistance of 1000 Ω			Visual examination	no visible damage					
				DCL	initial limit					
				$\Delta C/C$	within $\pm 10\%$ of initial value					
				DF	initial limit					
				ESR	initial limit					

*Initial Limit

QUALIFICATION TABLE – CATEGORY 2

TEST	TPC series (Temperature range -55°C to +125°C)									
	Condition			Characteristics						
Endurance	Apply rated voltage (Ur) at 85°C and / or category voltage (Uc) at 125°C for 2000 hours through a circuit impedance of $\leq 0.1\Omega/V$. Stabilize at room temperature for 1-2 hours before measuring.			Visual examination	no visible damage					
				DCL	1.25 x initial limit					
				$\Delta C/C$	within $\pm 15\%$ of initial value					
				DF	1.5 x initial limit					
				ESR	1.5 x initial limit					
Humidity	Store at 40°C and 90-95% relative humidity for 1344 hours, with no applied voltage. Stabilize at room temperature and humidity for 1-2 hours before measuring.			Visual examination	no visible damage					
				DCL	initial limit					
				$\Delta C/C$	within $\pm 10\%$ of initial value					
				DF	1.2 x initial limit					
				ESR	1.2 x initial limit					
Temperature Stability	Step	Temperature°C	Duration(min)		+20°C	-55°C	+20°C	+85°C	+125°C	+20°C
	1	+20	15	DCL	IL*	n/a	IL*	10 x IL*	12.5 x IL*	IL*
	2	-55	15		$\Delta C/C$	n/a	+0/-15%	$\pm 5\%$	+15/-0%	+20/-0%
	3	+20	15	DF	IL*	1.5 x IL*	IL*	1.5 x IL*	2 x IL*	IL*
	4	+85	15	ESR	IL*	1.25 x IL*	IL*	1.25 x IL*	2 x IL*	IL*
	5	+125	15							
6	+20	15								
Surge Voltage	Apply 1.3x rated voltage (Ur) at 85°C for 1000 cycles of duration 6 min (30 sec charge, 5 min 30 sec discharge) through a charge / discharge resistance of 1000 Ω			Visual examination	no visible damage					
				DCL	1.5 x initial limit					
				$\Delta C/C$	within $\pm 15\%$ of initial value					
				DF	1.5 x initial limit					
				ESR	1.5 x initial limit					

*Initial Limit

QUALIFICATION TABLE – CATEGORY 1

TEST	TPC series (Temperature range -55°C to +125°C)									
	Condition			Characteristics						
Endurance	Apply rated voltage (Ur) at 85°C and / or category voltage (Uc) at 125°C for 2000 hours through a circuit impedance of $\leq 0.1\Omega/V$. Stabilize at room temperature for 1-2 hours before measuring.			Visual examination	no visible damage					
				DCL	1.25 x initial limit					
				$\Delta C/C$	within $\pm 30\%$ of initial value					
				DF	1.5 x initial limit					
				ESR	1.5 x initial limit					
Humidity	Store at 40°C and 90-95% relative humidity for 1344 hours, with no applied voltage. Stabilize at room temperature and humidity for 1-2 hours before measuring.			Visual examination	no visible damage					
				DCL	2 x initial limit					
				$\Delta C/C$	within $\pm 30\%$ of initial value					
				DF	1.5 x initial limit					
				ESR	1.25 x initial limit					
Temperature Stability	Step	Temperature°C	Duration(min)		+20°C	-55°C	+20°C	+85°C	+125°C	+20°C
	1	+20	15	DCL	IL*	n/a	IL*	10 x IL*	12.5 x IL*	IL*
	2	-55	15		$\Delta C/C$	n/a	+0/-25%	$\pm 5\%$	+20/-0%	+25/-0%
	3	+20	15	DF		IL*	1.5 x IL*	IL*	1.5 x IL*	2 x IL*
	4	+85	15	ESR	IL*	1.25 x IL*	IL*	1.25 x IL*	2 x IL*	1.5 x IL*
	5	+125	15							
	6	+20	15							
Surge Voltage	Apply 1.3x rated voltage (Ur) at 85°C for 1000 cycles of duration 6 min (30 sec charge, 5 min 30 sec discharge) through a charge / discharge resistance of 1000 Ω			Visual examination	no visible damage					
				DCL	2 x initial limit					
				$\Delta C/C$	within $\pm 30\%$ of initial value					
				DF	2 x initial limit					
				ESR	2 x initial limit					

*Initial Limit

TPC Series

Low ESR TACmicrochip®

AVX SOLID ELECTROLYTIC CAPACITOR ROADMAP

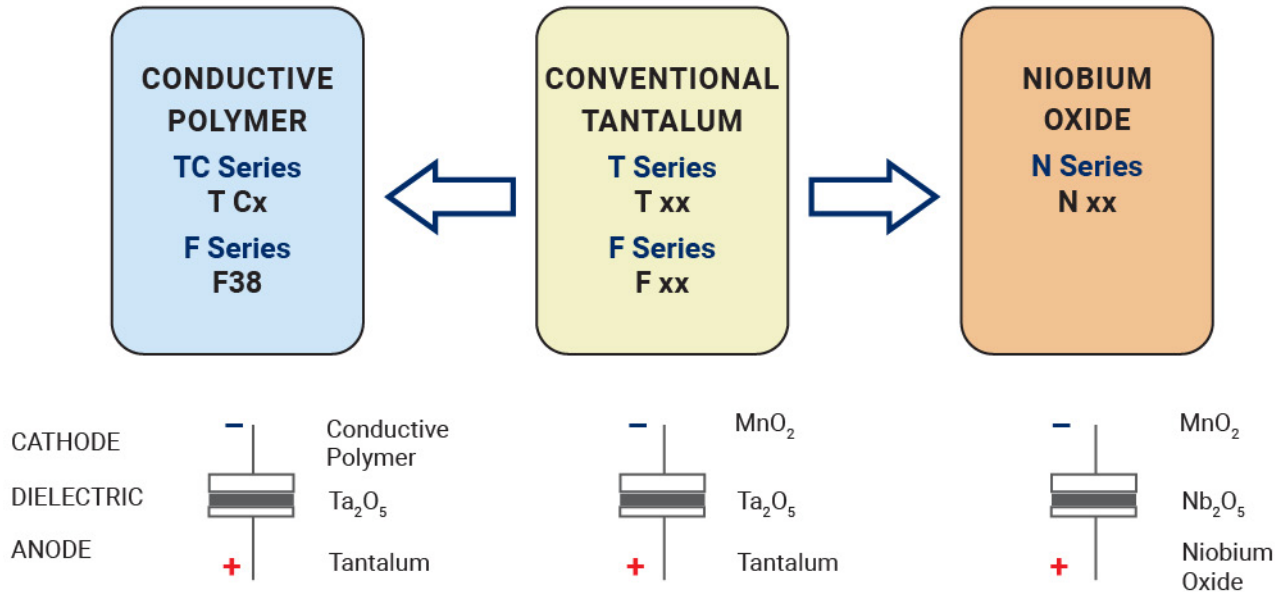

FIVE CAPACITOR CONSTRUCTION STYLES

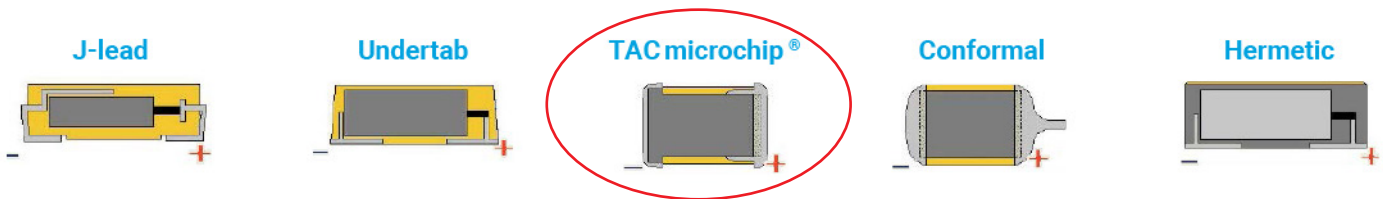

SERIES LINE UP : CONVENTIONAL SMD MnO₂

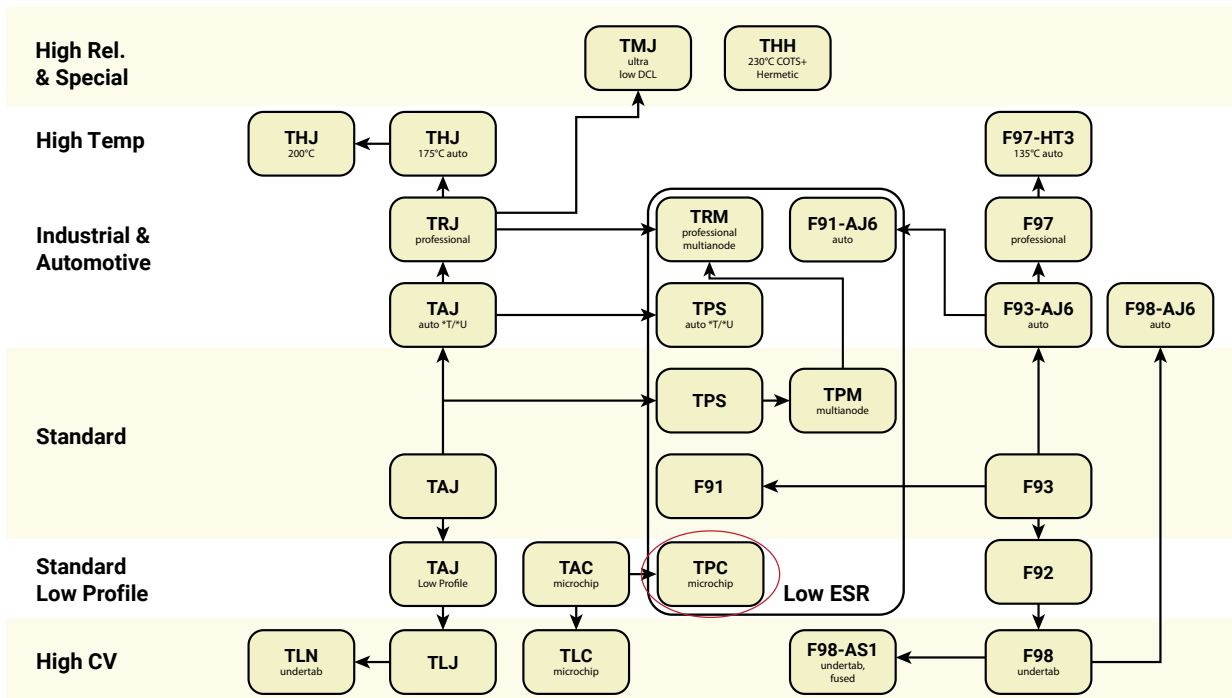

F95 Series

Standard Conformal Coated Chip

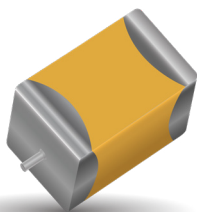

FEATURES

- Compliant to the RoHS3 directive 2015/863/EU
- For High Frequency
- SMD Conformal
- Small and High CV
- 100% Surge Current Tested

APPLICATIONS

- Smartphone
- Tablet PC
- Wireless Module
- E-book



CASE DIMENSIONS:

millimeters (inches)

Code	EIA Code	EIA Metric	L	W	H	A	B	C	D*
A	1207	32 17-16	3.20±0.30 (0.126±0.012)	1.70±0.30 (0.067±0.012)	1.40±0.20 (0.055±0.008)	0.80±0.30 (0.031±0.012)	1.20±0.30 (0.047±0.012)	0.80±0.30 (0.031±0.012)	0.20 (0.008)
B	1411	3528-20	3.50±0.20 (0.138±0.008)	2.80±0.20 (0.110±0.008)	1.80±0.20 (0.071±0.008)	0.80±0.30 (0.031±0.012)	1.20±0.30 (0.047±0.012)	1.10±0.30 (0.043±0.012)	0.20 (0.008)
P	0905	2212-12	2.20±0.30 (0.087±0.012)	1.25±0.30 (0.049±0.012)	1.00±0.20 (0.039±0.008)	0.60±0.30 (0.024±0.012)	0.80±0.30 (0.031±0.012)	0.80±0.30 (0.031±0.012)	0.20 (0.008)
Q	1306	3216-10	3.20±0.20 (0.126±0.008)	1.60±0.20 (0.063±0.008)	0.80±0.20 (0.031±0.008)	0.80±0.20 (0.031±0.008)	1.20±0.20 (0.047±0.008)	0.80±0.20 (0.031±0.008)	0.20 (0.008)
R	0905	2212-065	2.20±0.30 (0.087±0.012)	1.25±0.30 (0.049±0.012)	0.65 max. (0.026 max.)	0.60±0.30 (0.024±0.012)	0.80±0.30 (0.031±0.012)	0.50 min. (0.020 min.)	0.20 (0.008)
S	1306	3216-12	3.20±0.30 (0.126±0.012)	1.60±0.30 (0.063±0.012)	1.00±0.20 (0.039±0.008)	0.80±0.30 (0.031±0.012)	1.20±0.30 (0.047±0.012)	0.80±0.30 (0.031±0.012)	0.20 (0.008)
T	1411	3527-12	3.50±0.20 (0.138±0.008)	2.70±0.20 (0.106±0.008)	1.00±0.20 (0.039±0.008)	0.80±0.20 (0.031±0.008)	1.20±0.20 (0.047±0.008)	1.10±0.20 (0.043±0.012)	0.20 (0.008)

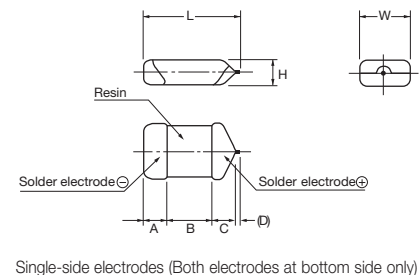

*D dimension only for reference

HOW TO ORDER

F95

Type

0G

Rated Voltage

337

Capacitance Code
pF code: 1st two digits represent significant figures, 3rd digit represents multiplier (number of zeros to follow)

M

Tolerance
K=±10%
M=±20%

A

Case Size
See table above

□

Packaging
See Tape & Reel Packaging Section

□□□

Specification Suffix
LZT = Rated temperature 60°C only

AQ2 or Q2

Single Face Electrode

TECHNICAL SPECIFICATIONS

Category Temperature Range:	-55 to +125°C
Rated Temperature:	+85°C
Capacitance Tolerance:	±20%, ±10% at 120Hz
Dissipation Factor:	Refer to next page
ESR 100kHz:	Refer to next page
Leakage Current:	Refer to next page Provided that: After 1 minute's application of rated voltage, leakage current at 85°C 10 times or less than 20°C specified value. After 1 minute's application of rated voltage, leakage current at 125°C 12.5 times or less than 20°C specified value.
Capacitance Change By Temperature	+15% Max. at +125°C +10% Max. at +85°C -10% Max. at -55°C

F95 Series

Standard Conformal Coated Chip



CAPACITANCE AND RATED VOLTAGE RANGE (LETTER DENOTES CASE SIZE)

Capacitance		Rated Voltage							
µF	Code	4V (0G)	6.3V (0J)	10V (1A)	16V (1C)	20V (1D)	25V (1E)	35V (1V)	50V (1H)
1.0	105						R	P/S	P ^{(M)*}
1.5	155								
2.2	225					P	P/R	A	
3.3	335								
4.7	475				P/R	A/S	A/P/Q/S	B	
6.8	685								
10	106			P/R ^(M)	A/P/Q/S	A/B/S	A/B		
15	156			P	A/S				
22	226		R ^(M)	A/P ^(M) /Q/S	A/B/Q/S/T	B			
33	336		P ^(M)	A/P ^(M) /Q/S	B/T	B			
47	476		P ^(M)	A/B/P ^(M) /S/T	B				
68	686		P ^(M)	B					
100	107	A/P/S	A/B/P ^(M) /Q/S/T	A/B/T					
150	157	B/P ^(M)	B						
220	227	A/B/Q/S/T	B						
330	337	A/B/T	B						
470	477	B	B						
680	687								

Released ratings ^(M tolerance only)

*Rated temperature 60°C only. Please contact AVX when you need detail spec.

Please contact to your local AVX sales office when these series are being designed in your application.

RATINGS & PART NUMBER REFERENCE

AVX Part No.	Case Size	Capacitance (µF)	Rated Voltage (V)	DCL (µA)	DF @ 120Hz (%)	ESR @ 100kHz (Ω)	100kHz RMS Current (mA)				*1 ΔC/C (%)	MSL
							25°C	60°C	85°C	125°C		
4 Volt												
F950G107#AAAQ2	A	100	4	4.0	12	0.5	387	-	349	155	*	3
F950G107#PAAQ2	P	100	4	4.0	30	1.2	158	-	142	63	±15	3
F950G107#SAAQ2	S	100	4	4.0	14	0.8	274	-	246	110	*	3
F950G157#BAAQ2	B	150	4	6.0	14	0.4	461	-	415	184	*	3
F950G157#MPAAQ2	P	150	4	12.0	31	1.1	165	-	149	66	±20	3
F950G227#AAAQ2	A	220	4	8.8	25	0.8	306	-	276	122	±15	3
F950G227#BAAQ2	B	220	4	8.8	16	0.4	461	-	415	184	*	3
F950G227#QAAQ2	Q	220	4	8.8	30	1.5	173	-	156	69	±20	3
F950G227#SAAQ2	S	220	4	8.8	30	0.8	274	-	246	110	±15	3
F950G227#TAAQ2	T	220	4	8.8	25	0.6	365	-	329	146	*	3
F950G337#AAAQ2	A	330	4	13.2	40	0.8	306	-	276	122	±20	3
F950G337#BAAQ2	B	330	4	13.2	30	0.6	376	-	339	151	±15	3
F950G337#TAAQ2	T	330	4	13.2	40	0.8	316	-	285	126	±20	3
F950G477#BAAQ2	B	470	4	18.8	40	0.4	461	-	415	184	±20	3
6.3 Volt												
F950J336#MPAAQ2	P	33	6.3	2.1	14	1.1	165	-	149	66	*	3
F950J226#MRAAQ2	R	22	6.3	1.4	20	2.0	112	-	101	45	±20	3
F950J476#MPAAQ2	P	47	6.3	3.0	20	1.1	165	-	149	66	±15	3
F950J686#MPAAQ2	P	68	6.3	4.3	25	1.2	158	-	142	63	±15	3
F950J107#AAAQ2	A	100	6.3	6.3	14	0.5	387	-	349	155	*	3
F950J107#BAAQ2	B	100	6.3	6.3	14	0.4	461	-	415	184	*	3
F950J107#MPAAQ2	P	100	6.3	12.6	35	1.2	158	-	142	63	±20	3
F950J107#QAAQ2	Q	100	6.3	6.3	30	1.1	202	-	182	81	±20	3
F950J107#SAAQ2	S	100	6.3	6.3	20	0.9	258	-	232	103	±15	3
F950J107#TAAQ2	T	100	6.3	6.3	14	0.6	365	-	329	146	*	3
F950J157#BAAQ2	B	150	6.3	9.5	18	0.4	461	-	415	184	*	3
F950J227#BAAQ2	B	220	6.3	13.9	30	0.4	461	-	415	184	*	3
F950J337#BAAQ2	B	330	6.3	20.8	35	0.6	376	-	339	151	±20	3
F950J477#BAAQ2	B	470	6.3	59.2	40	0.5	412	-	371	165	±20	3
10 Volt												
F951A106#PAAQ2	P	10	10	1.0	8	3.0	100	-	90	40	*	3
F951A106#MRAAQ2	R	10	10	1.0	18	3.0	91	-	82	37	±20	3
F951A156#PAAQ2	P	15	10	1.5	10	3.0	100	-	90	40	*	3
F951A226#AAAQ2	A	22	10	2.2	6	0.9	289	-	260	115	*	3
F951A226#MPAAQ2	P	22	10	2.2	14	3.0	100	-	90	40	*	3
F951A226#QAAQ2	Q	22	10	2.2	10	2.0	150	-	135	60	*	3
F951A226#SAAQ2	S	22	10	2.2	10	1.1	234	-	210	93	*	3
F951A336#AAAQ2	A	33	10	3.3	10	0.8	306	-	276	122	*	3
F951A336#MPAAQ2	P	33	10	3.3	20	3.0	100	-	90	40	±15	3
F951A336#QAAQ2	Q	33	10	3.3	18	3.0	122	-	110	49	±15	3
F951A336#SAAQ2	S	33	10	3.3	10	1.1	234	-	210	93	*	3
F951A476#AAAQ2	A	47	10	4.7	10	0.8	306	-	276	122	*	3



The Important Information/Disclaimer is incorporated in the catalog where these specifications came from or available online at www.avx.com/disclaimer/ by reference and should be reviewed in full before placing any order.

F95 Series

Standard Conformal Coated Chip



RATINGS & PART NUMBER REFERENCE

AVX Part No.	Case Size	Capacitance (µF)	Rated Voltage (V)	DCL (µA)	DF @ 120Hz (%)	ESR @ 100kHz (Ω)	100kHz RMS Current (mA)				*1 ΔC/C (%)	MSL
							25°C	60°C	85°C	125°C		
F951A476#BAAQ2	B	47	10	4.7	8	0.4	461	-	415	184	*	3
F951A476#PAAQ2	P	47	10	4.7	30	3.0	100	-	90	40	±20	3
F951A476#SAAQ2	S	47	10	4.7	14	1.1	234	-	210	93	±15	3
F951A476#TAAQ2	T	47	10	4.7	12	0.8	316	-	285	126	*	3
F951A686#BAAQ2	B	68	10	6.8	12	0.4	461	-	415	184	*	3
F951A107#AAAQ2	A	100	10	10.0	35	1.0	274	-	246	110	±15	3
F951A107#BAAQ2	B	100	10	10.0	14	0.4	461	-	415	184	*	3
F951A107#TAAQ2	T	100	10	10.0	20	0.6	365	-	329	146	±15	3
16 Volt												
F951C475#PAAQ2	P	4.7	16	0.8	10	4.0	87	-	78	35	*	3
F951C475#RAAQ2	R	4.7	16	0.8	12	6.0	65	-	58	26	±20	3
F951C106#AAAQ2	A	10	16	1.6	6	1.4	231	-	208	93	*	3
F951C106#PAAQ2	P	10	16	1.6	10	4.0	87	-	78	35	*	3
F951C106#QAAQ2	Q	10	16	1.6	8	3.0	122	-	110	49	*	3
F951C106#SAAQ2	S	10	16	1.6	8	2.0	173	-	156	69	*	3
F951C156#AAAQ2	A	15	16	2.4	8	1.4	231	-	208	93	*	3
F951C156#SAAQ2	S	15	16	2.4	8	2.0	173	-	156	69	*	3
F951C226#AAAQ2	A	22	16	3.5	8	1.4	231	-	208	93	*	3
F951C226#BAAQ2	B	22	16	3.5	6	0.5	412	-	371	165	*	3
F951C226#QAAQ2	Q	22	16	3.5	12	3.0	122	-	110	49	*	3
F951C226#SAAQ2	S	22	16	3.5	10	2.0	173	-	156	69	±15	3
F951C226#TAAQ2	T	22	16	3.5	8	1.4	239	-	215	96	*	3
F951C336#BAAQ2	B	33	16	5.3	8	0.5	412	-	371	165	*	3
F951C336#TAAQ2	T	33	16	5.3	11	1.5	231	-	208	92	±10	3
F951C476#BAAQ2	B	47	16	7.5	10	0.6	376	-	339	151	*	3
20 Volt												
F951D225#PAAQ2	P	2.2	20	0.5	6	6.0	71	-	64	28	*	3
F951D475#AAAQ2	A	4.7	20	0.9	6	1.5	224	-	201	89	*	3
F951D475#SAAQ2	S	4.7	20	0.9	8	4.0	122	-	110	49	*	3
F951D106#AAAQ2	A	10	20	2.0	8	1.5	224	-	201	89	*	3
F951D106#BAAQ2	B	10	20	2.0	6	0.8	326	-	293	130	*	3
F951D106#SAAQ2	S	10	20	2.0	10	4.0	122	-	110	49	±10	3
F951D226#BAAQ2	B	22	20	4.4	8	0.8	326	-	293	130	*	3
F951D336#BAAQ2	B	33	20	6.6	15	1.0	292	-	262	117	*	3
25 Volt												
F951E105#RAAQ2	R	1	25	0.5	10	10.0	50	-	45	20	±10	3
F951E225#PAAQ2	P	2.2	25	0.6	8	6.0	71	-	64	28	±15	3
F951E225#RAAQ2	R	2.2	25	0.6	15	15.0	41	-	37	16	±20	3
F951E475#AAAQ2	A	4.7	25	1.2	8	2.0	194	-	174	77	*	3
F951E475#PAAQ2	P	4.7	25	1.2	10	8.0	61	-	55	24	±15	3
F951E475#QAAQ2	Q	4.7	25	1.2	10	4.0	106	-	95	42	±15	3
F951E475#SAAQ2	S	4.7	25	1.2	8	4.0	122	-	110	49	*	3
F951E106#AAAQ2	A	10	25	2.5	12	2.0	194	-	174	77	±15	3
F951E106#BAAQ2	B	10	25	2.5	6	0.9	307	-	227	123	*	3
35 Volt												
F951V105#PAAQ2	P	1	35	0.5	8	10.0	55	-	49	22	±10	3
F951V105#SAAQ2	S	1	35	0.5	6	8.0	87	-	78	35	*	3
F951V225#AAAQ2	A	2.2	35	0.8	6	4.4	131	-	118	52	*	3
F951V475#BAAQ2	B	4.7	35	1.7	6	1.6	230	-	207	92	*	3
50 Volt												
F951H105MPALZTQ2	P	1	50	1.0	8	7.0	65	59	-	26	±20	3

1: ΔC/C Marked ""

#: "M" for ±20% tolerance, "K" for ±10% tolerance. When you need K tolerance for the part numbers which have M tolerance only, please contact to your local AVX sales office.

Moisture Sensitivity Level (MSL) is defined according to J-STD-020.

Item	All Case (%)
Damp Heat	±10
Temperature cycles	±5
Resistance soldering heat	±5
Surge	±5
Endurance	±10

F95 Series

Standard Conformal Coated Chip

QUALIFICATION TABLE

TEST	F95 series (Temperature range -55°C to +125°C)	
	Condition	
Damp Heat (Steady State)	At 40°C, 90 to 95% R.H., 500 hours (No voltage applied) Capacitance Change Refer to page 166 (*1) Dissipation Factor Initial specified value or less Leakage Current Initial specified value or less	
Temperature Cycles	At -55°C / +125°C, 30 minutes each, 5 cycles Capacitance Change Refer to page 166 (*1) Dissipation Factor Initial specified value or less Leakage Current Initial specified value or less	
Resistance to Soldering Heat	10 seconds reflow at 260°C, 10 seconds immersion at 260°C. Capacitance Change Refer to page 166 (*1) Dissipation Factor Initial specified value or less Leakage Current Initial specified value or less	
Surge	After application of surge voltage in series with a 33Ω resistor at the rate of 30 seconds ON, 30 seconds OFF, for 1000 successive test cycles at 85°C, capacitors shall meet the characteristic requirements in the table above. Capacitance Change Refer to page 166 (*1) Dissipation Factor Initial specified value or less Leakage Current Initial specified value or less	
Endurance	After 2000 hours' application of rated voltage at 85°C, capacitors shall meet the characteristic requirements in the table above. Capacitance Change Refer to page 166 (*1) Dissipation Factor Initial specified value or less Leakage Current Initial specified value or less	
Shear Test	After applying the pressure load of 5N for 10±1 seconds horizontally to the center of capacitor side body which has no electrode and has been soldered beforehand on a substrate, there shall be found neither exfoliation nor its sign at the terminal electrode.	
Terminal Strength	Keeping a capacitor surface-mounted on a substrate upside down and supporting the substrate at both of the opposite bottom points 45mm apart from the center of capacitor, the pressure strength is applied with a specified jig at the center of substrate so that the substrate may bend by 1mm as illustrated. Then, there shall be found no remarkable abnormality on the capacitor terminals.	

AVX SOLID ELECTROLYTIC CAPACITOR ROADMAP

SERIES LINE UP : CONVENTIONAL SMD MnO₂

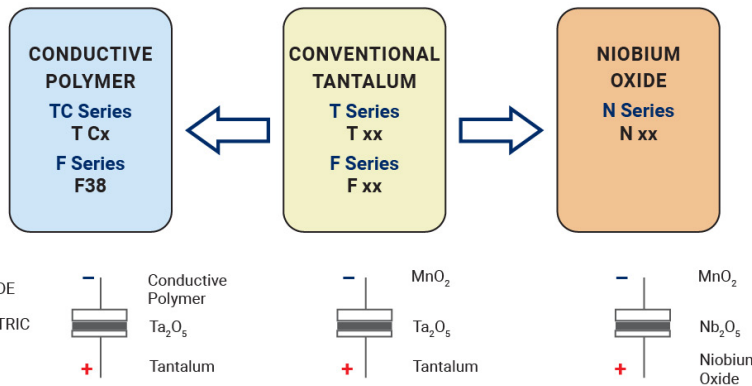

FIVE CAPACITOR CONSTRUCTION STYLES

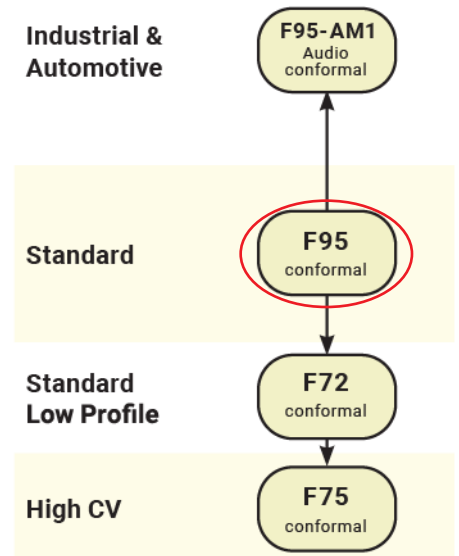
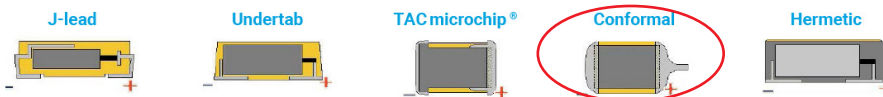

F95 Audio Series

Conformal Coated Chip Optimized for Audio Applications

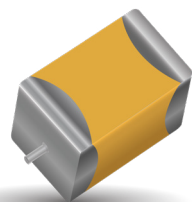

FEATURES

- Compliant to the RoHS3 directive 2015/863/EU
- Rich Sound in the Bass Register and Clear Sound
- Materials are Strictly Selected to Achieve High Level Sound
- F95 Series has No Lead-Frame and No Vibration Factor
- Low ESR, Low ESL
- 100% Surge Current Tested
- Line Up Miniature Size and High Capacitance, Necessary to Mobile Design
- SMD Conformal
- Small and High CV



LEAD-FREE
LEAD-FREE COMPATIBLE
COMPONENT



APPLICATIONS

- Mobile Audio Player
- Smartphone
- Mobile Phone
- Wireless Microphone System

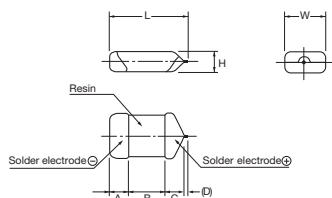

Single-side electrodes
(Both electrodes at bottom side only)

CASE DIMENSIONS:

millimeters (inches)

Code	EIA Code	EIA Metric	L	W	H	A	B	C	D*
B	1411	3528-20	3.50±0.20 (0.138±0.008)	2.80±0.20 (0.110±0.008)	1.80±0.20 (0.071±0.008)	0.80±0.30 (0.031±0.012)	1.20±0.30 (0.047±0.012)	1.10±0.30 (0.043±0.012)	0.20 (0.008)
S	1306	3216-12	3.20±0.30 (0.126±0.012)	1.60±0.30 (0.063±0.012)	1.00±0.20 (0.039±0.008)	0.80±0.30 (0.031±0.012)	1.20±0.30 (0.047±0.012)	0.80±0.30 (0.031±0.012)	0.20 (0.008)
T	1411	3527-12	3.50±0.20 (0.138±0.008)	2.70±0.20 (0.106±0.008)	1.00±0.20 (0.039±0.008)	0.80±0.20 (0.031±0.008)	1.20±0.20 (0.047±0.008)	1.10±0.20 (0.043±0.012)	0.20 (0.008)

*D dimension only for reference

MARKING

S CASE

B, T CASE



Capacitance Code



Capacitance Code

µF	68	100	150	220	330	470	680
code	W7	A8	E8	J8	N8	S8	W8

HOW TO ORDER

F95

Type

0G

Rated Voltage

227

Capacitance Code
pF code: 1st two digits represent significant figures, 3rd digit represents multiplier (number of zeros to follow)

M

Tolerance
K=±10%
M=±20%

S

Case Size
See table above

□

Packaging
See Tape & Reel Packaging Section

AM1

AUDIO Series Code

Q2

Single Face Electrode

TECHNICAL SPECIFICATIONS

Category Temperature Range:	-55 to +125°C
Rated Temperature:	+85°C
Capacitance Tolerance:	±20%, ±10% at 120Hz
Dissipation Factor:	Refer to next page
ESR 100kHz:	Refer to next page
Leakage Current:	Refer to next page Provided that: After 1 minute's application of rated voltage, leakage current at 85°C 10 times or less than 20°C specified value. After 1 minute's application of rated voltage, leakage current at 125°C 12.5 times or less than 20°C specified value.
Capacitance Change By Temperature	+15% Max. at +125°C +10% Max. at +85°C -10% Max. at -55°C

F95 Audio Series

Conformal Coated Chip Optimized for Audio Applications



CAPACITANCE AND RATED VOLTAGE RANGE (LETTER DENOTES CASE SIZE)

Capacitance		Rated Voltage		
μF	Code	4V (0G)	6.3V (0J)	10V (1A)
68	686	S	S	B
100	107	S	S/T	B
150	157	S		
220	227	S/T	B	
330	337	T	B	
470	477	B		
680	687			

Released ratings

Please contact to your local AVX sales office when these series are being designed in your application.

RATINGS & PART NUMBER REFERENCE

AVX Part No.	Case Size	Capacitance (μF)	Rated Voltage (V)	DCL (μA)	DF @ 120Hz (%)	ESR @ 100kHz (Ω)	100kHz RMS Current (mA)			*1 ΔC/C (%)	MSL
							25°C	85°C	125°C		
4 Volt											
F950G686#SAAM1Q2	S	68	4	2.7	10	0.8	274	246	110	*	3
F950G107#SAAM1Q2	S	100	4	4.0	14	0.8	274	246	110	*	3
F950G157#SAAM1Q2	S	150	4	6.0	22	0.8	274	246	110	±15	3
F950G227#SAAM1Q2	S	220	4	8.8	30	0.8	274	246	110	±15	3
F950G227#TAAM1Q2	T	220	4	8.8	25	0.6	365	329	146	*	3
F950G337#TAAM1Q2	T	330	4	13.2	40	0.8	316	285	126	±20	3
F950G477#BAAM1Q2	B	470	4	18.8	40	0.4	461	415	184	±20	3
6.3 Volt											
F950J686#SAAM1Q2	S	68	6.3	4.3	14	0.9	258	232	103	*	3
F950J107#SAAM1Q2	S	100	6.3	6.3	20	0.9	258	232	103	±15	3
F950J107#TAAM1Q2	T	100	6.3	6.3	14	0.6	365	329	146	*	3
F950J227#BAAM1Q2	B	220	6.3	13.9	30	0.4	461	415	184	*	3
F950J337#BAAM1Q2	B	330	6.3	20.8	35	0.6	376	339	151	±20	3
10 Volt											
F951A686#BAAM1Q2	B	68	10	6.8	12	0.4	461	415	184	*	3
F951A107#BAAM1Q2	B	100	10	10.0	14	0.4	461	415	184	*	3

*1: ΔC/C Marked "**"

#: "M" for ±20% tolerance, "K" for ± 10% tolerance.

Moisture Sensitivity Level (MSL) is defined according to J-STD-020.

Item	All Case (%)
Damp Heat	±10
Temperature cycles	±5
Resistance soldering heat	±5
Surge	±5
Endurance	±10

F95 Audio Series

Conformal Coated Chip Optimized for Audio Applications

QUALIFICATION TABLE

TEST	Audio F95 series (Temperature range -55°C to +125°C)	
	Condition	
Damp Heat (Steady State)	At 40°C, 90 to 95% R.H., 500 hours (No voltage applied) Capacitance Change Refer to page 170 (*1) Dissipation Factor Initial specified value or less Leakage Current Initial specified value or less	
Temperature Cycles	At -55°C / +125°C, 30 minutes each, 5 cycles Capacitance Change Refer to page 170 (*1) Dissipation Factor Initial specified value or less Leakage Current Initial specified value or less	
Resistance to Soldering Heat	10 seconds reflow at 260°C, 5 seconds immersion at 260°C. Capacitance Change Refer to page 170 (*1) Dissipation Factor Initial specified value or less Leakage Current Initial specified value or less	
Surge	After application of surge voltage in series with a 33Ω resistor at the rate of 30 seconds ON, 30 seconds OFF, for 1000 successive test cycles at 85°C, capacitors shall meet the characteristic requirements in the table above. Capacitance Change Refer to page 170 (*1) Dissipation Factor Initial specified value or less Leakage Current Initial specified value or less	
Endurance	After 2000 hours' application of rated voltage 85°C, capacitors shall meet the characteristic requirements in the table above. Capacitance Change Refer to page 170 (*1) Dissipation Factor Initial specified value or less Leakage Current Initial specified value or less	
Shear Test	After applying the pressure load of 5N for 10±1 seconds horizontally to the center of capacitor side body which has no electrode and has been soldered beforehand on a substrate, there shall be found neither exfoliation nor its sign at the terminal electrode.	
Terminal Strength	Keeping a capacitor surface-mounted on a substrate upside down and supporting the substrate at both of the opposite bottom points 45mm apart from the center of capacitor, the pressure strength is applied with a specified jig at the center of substrate so that the substrate may bend by 1mm as illustrated. Then, there shall be found no remarkable abnormality on the capacitor terminals.	

AVX SOLID ELECTROLYTIC CAPACITOR ROADMAP

SERIES LINE UP : CONVENTIONAL SMD MnO₂

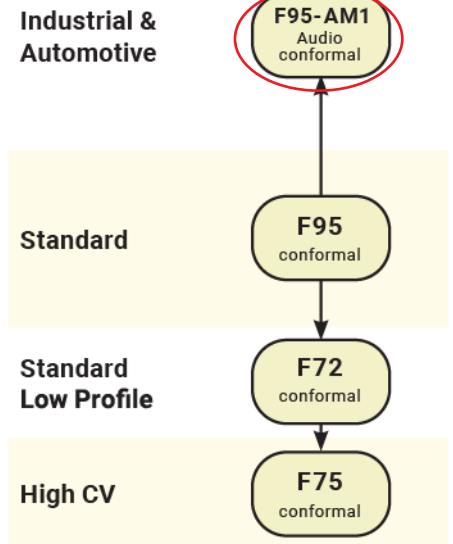
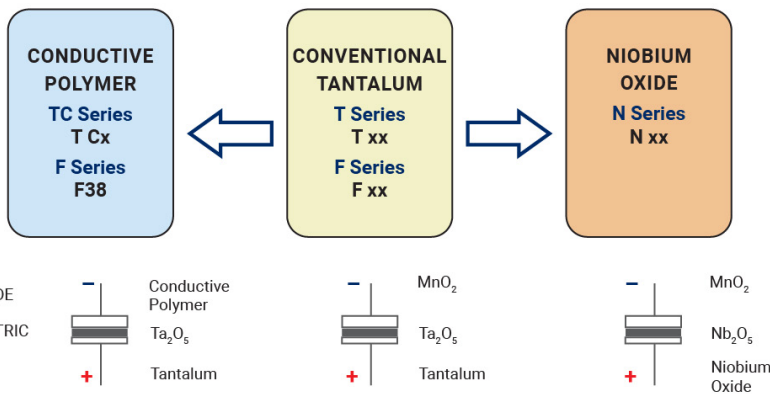

FIVE CAPACITOR CONSTRUCTION STYLES



F72/F75 Series

Low Profile and High CV Conformal Coated Chip

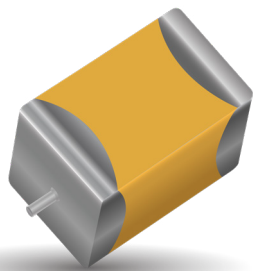

FEATURES

- Compliant to the RoHS3 directive 2015/863/EU
- SMD Conformal
- Small and Low Profile
- 100% Surge Current Tested



LEAD-FREE
LEAD-FREE COMPATIBLE
COMPONENT



RoHS
COMPLIANT

APPLICATIONS

- Smartphone
- Mobile Phone
- Wireless Module
- Hearing Aid

CASE DIMENSIONS:

millimeters (inches)

Code	EIA Code	EIA Metric	L	W	H	A	B	D*
F72 Case Dimensions								
D	2914	7343-20	7.30±0.30 (0.287±0.012)	4.30±0.30 (0.169±0.012)	2.00 Max. (0.079 Max)	1.30±0.40 (0.051±0.016)	3.90±0.60 (0.153±0.024)	6.40 (0.252)
M	2824	7260-20	7.20±0.30 (0.283±0.012)	6.00±0.30 (0.236±0.012)	2.00 Max. (0.079 Max)	1.30±0.40 (0.051±0.016)	3.80±0.60 (0.150±0.024)	6.20 (0.244)
R	2824	7260-15	7.20±0.30 (0.283±0.012)	6.00±0.30 (0.236±0.012)	1.20±0.30 (0.047±0.012)	1.30±0.40 (0.051±0.016)	3.80±0.60 (0.150±0.024)	6.20 (0.244)
F75 Case Dimensions								
C	2813	7132-28	7.10±0.30 (0.280±0.012)	3.20±0.30 (0.126±0.012)	2.50±0.30 (0.098±0.012)	1.30±0.30 (0.051±0.012)	3.60±0.60 (0.142±0.024)	6.00 (0.236)
D	2914	7343-31	7.30±0.30 (0.287±0.012)	4.30±0.30 (0.169±0.012)	2.80±0.30 (0.110±0.012)	1.30±0.40 (0.051±0.016)	3.90±0.60 (0.153±0.024)	6.40 (0.252)
M	2824	7260-28	7.20±0.30 (0.283±0.012)	6.00±0.30 (0.236±0.012)	2.80 Max. (0.110 Max)	1.30±0.40 (0.051±0.016)	3.80±0.60 (0.150±0.024)	6.20 (0.244)
R	2824	7260-38	7.20±0.30 (0.283±0.012)	6.00±0.30 (0.236±0.012)	3.50±0.30 (0.138±0.012)	1.30±0.40 (0.051±0.016)	3.80±0.60 (0.150±0.024)	6.20 (0.244)
U	2813	7132-20	7.10±0.30 (0.280±0.012)	3.20±0.30 (0.126±0.012)	2.00 Max. (0.079 Max)	1.30±0.30 (0.051±0.012)	3.60±0.60 (0.142±0.024)	6.00 (0.236)

Under development
*D dimension only for reference

F72/F75

Double Face Electrode

Single Face Electrode

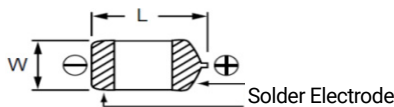
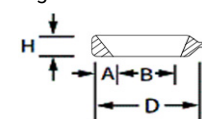
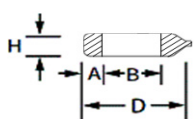

HOW TO ORDER

F72

Type

1A

Rated Voltage

107

Capacitance Code
pF code: 1st two digits represent significant figures, 3rd digit represents multiplier (number of zeros to follow)

M

Tolerance
K=±10%
M=±20%

R

Case Size
See table above

□

Packaging
See Tape & Reel Packaging Section

□□□

Specification Suffix
AH1 = Low ESR

AQ2 or Q2

Single Face Electrode

F75

Type

1C

Rated Voltage

157

Capacitance Code
pF code: 1st two digits represent significant figures, 3rd digit represents multiplier (number of zeros to follow)

M

Tolerance
K=±10%
M=±20%

D

Case Size
See table above

□

Packaging
See Tape & Reel Packaging Section

AQ2

Single Face Electrode

TECHNICAL SPECIFICATIONS

Category Temperature Range:	-55 to +125°C
Rated Temperature:	+85°C
Capacitance Tolerance:	±20%, ±10% at 120Hz
Dissipation Factor:	Refer to next page
ESR 100kHz:	Refer to next page
Leakage Current:	After 1 minute's application of rated voltage, leakage current at 20°C is not more than 0.01CV or 0.5µA, whichever is greater. After 1 minute's application of rated voltage, leakage current at 85°C is not more than 0.1CV or 5µA, whichever is greater. After 1 minute's application of derated voltage, leakage current at 125°C is not more than 0.125CV or 6.3µA, whichever is greater.
Capacitance Change By Temperature	+15% Max. at +125°C +10% Max. at +85°C -10% Max. at -55°C

F72/F75 Series

Low Profile and High CV Conformal Coated Chip



CAPACITANCE AND RATED VOLTAGE RANGE (LETTER DENOTES CASE SIZE)

F72

Capacitance		Rated Voltage			
µF	Code	4V (0G)	6.3V (0J)	10V (1A)	16V (1C)
33	336				R
47	476			R	R
68	686		R	R	R
100	107	R	R	R	D*
150	157	R	R	R	
220	227	R	R	R	M
330	337	R	R		M
470	477			M	
680	687			M	
1000	108		M/M(AH1)	M	
1500	158		M		

F75

Capacitance		Rated Voltage			
µF	Code	4V (0G)	6.3V (0J)	10V (1A)	16V (1C)
68	686				C
100	107				C
150	157			C	D
220	227		C	C/D	R
330	337	C	C/D	D	
470	477	C/D	D/U	R/U	
680	687	D	D/R		
1000	108	D/R	R/U		
1500	158	R			
2200	228	R	M		

Released ratings

*Codes under development - subject to change.

Please contact to your local AVX sales office when these series are being designed in your application.

RATINGS & PART NUMBER REFERENCE

F72

AVX Part No.	Case Size	Capacitance (µF)	Rated Voltage (V)	DCL (µA)	DF @ 120Hz (%)	ESR @ 100kHz (Ω)	100kHz RMS Current (mA)			*1 ΔC/C (%)	MSL
							25°C	85°C	125°C		
4 Volt											
F720G107#RC	R	100	4	4.0	8	0.70	463	417	185	*	3
F720G157#RC	R	150	4	6.0	10	0.70	463	417	185	*	3
F720G227#RC	R	220	4	8.8	12	0.70	463	417	185	*	3
F720G337#RC	R	330	4	13.2	12	0.70	463	417	185	*	3
6.3 Volt											
F720J686#RC	R	68	6.3	4.3	6	0.75	447	402	179	*	3
F720J107#RC	R	100	6.3	6.3	8	0.70	463	417	185	*	3
F720J157#RC	R	150	6.3	9.5	10	0.70	463	417	185	*	3
F720J227#RC	R	220	6.3	13.9	12	0.70	463	417	185	*	3
F720J337#RC	R	330	6.3	20.8	12	0.70	463	417	185	*	3
F720J108#MCAQ2	M	1000	6.3	63.0	30	0.14	1118	1006	447	±15	3
F720J108#MCAH1Q2	M	1000	6.3	63.0	30	0.075	1528	1375	611	±15	3
F720J158#MCAQ2	M	1500	6.3	95.0	45	0.14	1118	1006	447	±20	3
10 Volt											
F721A476#RC	R	47	10	4.7	6	0.80	433	390	173	*	3
F721A686#RC	R	68	10	6.8	6	0.75	447	402	179	*	3
F721A107#RC	R	100	10	10.0	8	0.70	463	417	185	*	3
F721A157#RC	R	150	10	15.0	10	0.70	463	417	185	*	3
F721A227#RC	R	220	10	22.0	12	0.70	463	417	185	*	3
F721A477#MCAQ2	M	470	10	47.0	30	0.14	1118	1006	447	±15	3
F721A687#MCAQ2	M	680	10	68.0	35	0.14	1118	1006	447	±20	3
F721A108#MCAQ2	M	1000	10	200	45	0.14	1118	1006	447	±20	3
16 Volt											
F721C336#RC	R	33	16	5.3	6	0.90	408	367	163	*	3
F721C476#RC	R	47	16	7.5	6	0.80	433	390	173	*	3
F721C686#RC	R	68	16	10.9	6	0.75	447	402	179	*	3
F721C107#DCAQ2	D	100	16	16.0	10	0.20	866	779	346	*	3
F721C227#MCAQ2	M	220	16	35.2	12	0.20	935	842	374	±20	3
F721C337#MCAQ2	M	330	16	52.8	45	0.20	935	842	374	±20	3

F75

AVX Part No.	Case Size	Capacitance (µF)	Rated Voltage (V)	DCL (µA)	DF @ 120Hz (%)	ESR @ 100kHz (Ω)	100kHz RMS Current (mA)			*1 ΔC/C (%)	MSL
							25°C	85°C	125°C		
4 Volt											
F750G337#CC	C	330	4	13.2	10	0.15	856	771	343	*	3
F750G477#CC	C	470	4	18.8	14	0.12	957	862	383	*	3
F750G477#DC	D	470	4	18.8	14	0.12	1118	1006	447	*	3
F750G687#DC	D	680	4	27.2	18	0.12	1118	1006	447	*	3
F750G108#DC	D	1000	4	40.0	24	0.12	1118	1006	447	*	3
F750G108#RC	R	1000	4	40.0	24	0.12	1443	1299	577	*	3
F750G158#RC	R	1500	4	60.0	30	0.12	1443	1299	577	*	3
F750G228#RC	R	2200	4	88.0	45	0.07	1890	1701	756	*	3
6.3 Volt											
F750J227#CC	C	220	6.3	13.9	10	0.20	742	667	297	*	3
F750J337#CC	C	330	6.3	20.8	10	0.15	856	771	343	*	3
F750J337#DC	D	330	6.3	20.8	10	0.15	1000	900	400	*	3
F750J477#DC	D	470	6.3	29.6	14	0.12	1118	1006	447	*	3

F72/F75 Series

Low Profile and High CV Conformal Coated Chip

RATINGS & PART NUMBER REFERENCE

AVX Part No.	Case Size	Capacitance (µF)	Rated Voltage (V)	DCL (µA)	DF @ 120Hz (%)	ESR @ 100kHz (Ω)	100kHz RMS Current (mA)			*1 ΔC/C (%)	MSL
							25°C	85°C	125°C		
F750J477#UC	U	470	6.3	29.6	15	0.10	1049	944	420	*	3
F750J687#DC	D	680	6.3	42.8	18	0.12	1118	1006	447	*	3
F750J687#RC	R	680	6.3	42.8	18	0.12	1443	1299	577	*	3
F750J108#RC	R	1000	6.3	63.0	24	0.12	1443	1299	577	*	3
F750J108#UCAQ2	U	1000	6.3	126	40	0.15	856	771	343	±20	3
F750J228#MCAQ2	M	2200	6.3	139	60	0.08	1581	1423	632	±20	3
10 Volt											
F751A157#CC	C	150	10	15.0	10	0.22	707	636	283	*	3
F751A227#CC	C	220	10	22.0	10	0.20	742	667	297	*	3
F751A227#DC	D	220	10	22.0	10	0.20	866	779	346	*	3
F751A337#DC	D	330	10	33.0	10	0.15	1000	900	400	*	3
F751A477#RC	R	470	10	47.0	14	0.12	1443	1299	577	*	3
F751A477#UCAQ2	U	470	10	94.0	30	0.15	856	771	343	±20	3
16 Volt											
F751C686#CC	C	68	16	10.9	10	0.22	707	636	283	*	3
F751C107#CC	C	100	16	16.0	10	0.22	707	636	283	*	3
F751C157#DC	D	150	16	24.0	10	0.22	826	743	330	*	3
F751C227#RC	R	220	16	35.2	10	0.20	1118	1006	447	*	3

1: ΔC/C Marked “”

#: “M” for ±20% tolerance, “K” for ±10% tolerance.
Moisture Sensitivity Level (MSL) is defined according to J-STD-020.

Item	F72/F75 All Case (%)
Damp Heat	±10
Temperature cycles	±5
Resistance soldering heat	±5
Surge	±5
Endurance	±10

QUALIFICATION TABLE

TEST	F72/F75 series (Temperature range -55°C to +125°C)	
	Condition	
Damp Heat (Steady State)	At 40°C, 90 to 95% R.H., 500 hours (No voltage applied) Capacitance Change Refer to page 174 (*1) Dissipation Factor Initial specified value or less Leakage Current Initial specified value or less	
Temperature Cycles	At -55°C / +125°C, 30 minutes each, 5 cycles Capacitance Change Refer to page 174 (*1) Dissipation Factor Initial specified value or less Leakage Current Initial specified value or less	
Resistance to Soldering Heat	10 seconds reflow at 260°C, 10 seconds immersion at 260°C. Capacitance Change Refer to page 174 (*1) Dissipation Factor Initial specified value or less Leakage Current Initial specified value or less	
Surge	After application of surge voltage in series with a 33Ω resistor at the rate of 30 seconds ON, 30 seconds OFF, for 1000 successive test cycles at 85°C, capacitors shall meet the characteristic requirements in the table above. Capacitance Change Refer to page 174 (*1) Dissipation Factor Initial specified value or less Leakage Current Initial specified value or less	
Endurance	After 2000 hours' application of rated voltage at 85°C, capacitors shall meet the characteristic requirements in the table above. Capacitance Change Refer to page 174 (*1) Dissipation Factor Initial specified value or less Leakage Current Initial specified value or less	
Shear Test	After applying the pressure load of 5N for 10±1 seconds horizontally to the center of capacitor side body which has no electrode and has been soldered beforehand on a substrate, there shall be found neither exfoliation nor its sign at the terminal electrode.	
Terminal Strength	Keeping a capacitor surface-mounted on a substrate upside down and supporting the substrate at both of the opposite bottom points 45mm apart from the center of capacitor, the pressure strength is applied with a specified jig at the center of substrate so that the substrate may bend by 1mm as illustrated. Then, there shall be found no remarkable abnormality on the capacitor terminals.	

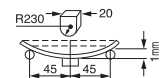
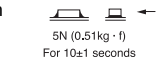

F72/F75 Series

Low Profile and High CV Conformal Coated Chip

AVX SOLID ELECTROLYTIC CAPACITOR ROADMAP

SERIES LINE UP : CONFORMAL Ta MnO₂

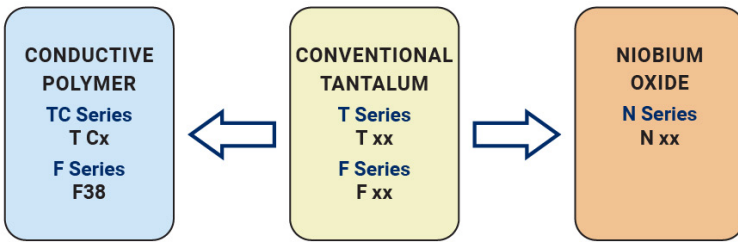

FIVE CAPACITOR CONSTRUCTION STYLES

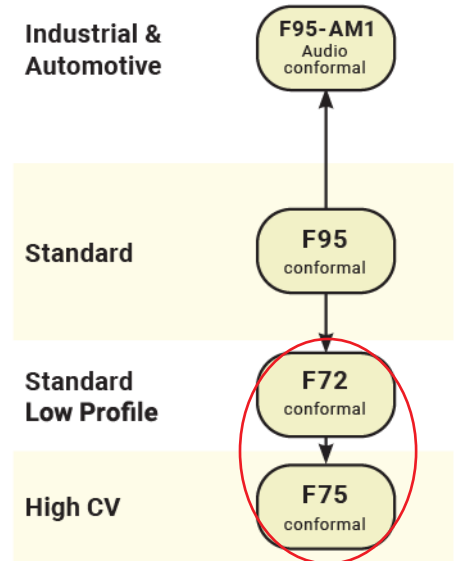
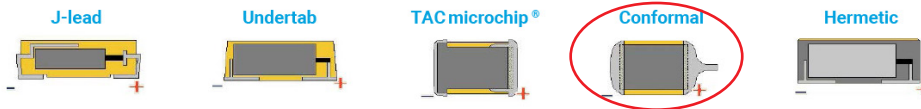

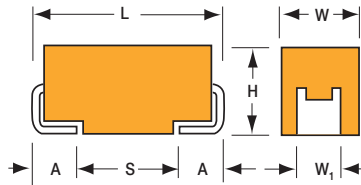
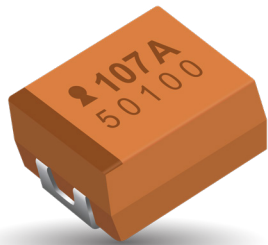

MARKING

A, B, C, D, E, F, S, T, V, W, X, Y CASE

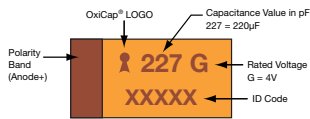

P CASE

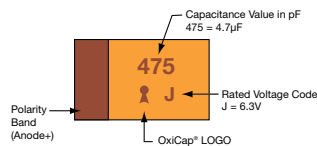

FEATURES

- Non-Burn Safe Technology
- Reliability Level: 0.5%/1000 Hours at 85°C
- 100% Surge Current Tested
- 13 Case Sizes Available, Standard and Low Profile
- Environmentally Friendly, RoHS Compliant
- CV Range: 2.2-1000µF / 1.8-10V
- Elektra Component of the Year Award, 2005



Elektra Award 2005

APPLICATIONS

- Automotive, Avionics, Digital, FPGA, Industrial Low Voltage Control Circuits
- Downsized Industrial and Automotive DC/DC Converters

STANDARD CASE DIMENSIONS:

millimeters (inches)

Code	EIA Code	EIA Metric	L±0.20 (0.008)	W+0.20 (0.008) -0.10 (0.004)	H+0.20 (0.008) -0.10 (0.004)	W ₁ ±0.20 (0.008)	A+0.30 (0.012) -0.20 (0.008)	S Min.
A	1206	3216-18	3.20 (0.126)	1.60 (0.063)	1.60 (0.063)	1.20 (0.047)	0.80 (0.031)	1.10 (0.043)
B	1210	3528-21	3.50 (0.138)	2.80 (0.110)	1.90 (0.075)	2.20 (0.087)	0.80 (0.031)	1.40 (0.055)
C	2312	6032-28	6.00 (0.236)	3.20 (0.126)	2.60 (0.102)	2.20 (0.087)	1.30 (0.051)	2.90 (0.114)
D	2917	7343-31	7.30 (0.287)	4.30 (0.169)	2.90 (0.114)	2.40 (0.094)	1.30 (0.051)	4.40 (0.173)
E	2917	7343-43	7.30 (0.287)	4.30 (0.169)	4.10 (0.162)	2.40 (0.094)	1.30 (0.051)	4.40 (0.173)
V	2924	7361-38	7.30 (0.287)	6.10 (0.240)	3.55 (0.140)	3.10 (0.122)	1.30 (0.051)	4.40 (0.173)

W₁ dimension applies to the termination width for A dimensional area only.

LOW PROFILE CASE DIMENSIONS:

millimeters (inches)

Code	EIA Code	EIA Metric	L±0.20 (0.008)	W+0.20 (0.008) -0.10 (0.004)	H Max	W ₁ ±0.20 (0.008)	A+0.30 (0.012) -0.20 (0.008)	S Min.
F	2312	6032-20	6.00 (0.236)	3.20 (0.126)	2.00 (0.079)	2.20 (0.087)	1.30 (0.051)	2.90 (0.114)
P	0805	2012-15	2.05 (0.081)	1.35 (0.053)	1.50 (0.059)	1.00±0.10 (0.039±0.004)	0.80 (0.031)	1.40 (0.055)
S	1206	3216-12	3.20 (0.126)	1.60 (0.063)	1.20 (0.047)	1.20 (0.047)	0.80 (0.031)	1.10 (0.043)
T	1210	3528-12	3.50 (0.138)	2.80 (0.110)	1.20 (0.047)	2.20 (0.087)	0.80 (0.031)	1.40 (0.055)
W	2312	6032-15	6.00 (0.236)	3.20 (0.126)	1.50 (0.059)	2.20 (0.087)	1.30 (0.051)	2.90 (0.114)
X	2917	7343-15	7.30 (0.287)	4.30 (0.169)	1.50 (0.059)	2.40 (0.094)	1.30 (0.051)	4.40 (0.173)
Y	2917	7343-20	7.30 (0.287)	4.30 (0.169)	2.00 (0.079)	2.40 (0.094)	1.30 (0.051)	4.40 (0.173)

W₁ dimension applies to the termination width for A dimensional area only.

Pad Stand-off is 0.1±0.1.

HOW TO ORDER

NOJ
Type

D
Case Size
See table above

107
Capacitance Code
1st two digits represent significant figures, 3rd digit represents multiplier in pF

M
Tolerance
M = ±20%

006
Rated DC Voltage
001 = 1.8Vdc
002 = 2.5Vdc
004 = 4Vdc
006 = 6.3Vdc
010 = 10Vdc

R
Packaging
R = Pure Tin 7" Reel
S = Pure Tin 13" Reel

WJ
Specification Suffix
WJ = Standard
WB = Low ESR

-
Additional characters may be added for special requirements
V = dry pack option (selected ratings only - dry pack is standard for all D, E, V, X, Y case size ratings)

TECHNICAL SPECIFICATIONS

Technical Data:	All technical data relate to an ambient temperature of +25°C is not stated						
Capacitance Range:	2.2 µF to 1000 µF						
Capacitance Tolerance:	±20%						
Leakage Current DCL:	0.02CV or 1.0µA whichever is the greater						
Rated Voltage (V _R)	≤ +85°C:	1.8	2.5	4	6.3	10	
Category Voltage (V _C)	≤ +105°C:	1.2	1.7	2.7	4	7	
Surge Voltage (V _S)	≤ +85°C:	2.3	3.3	5.2	8	13	
Surge Voltage (V _S)	≤ +105°C:	1.6	2.2	3.4	5	8	
Temperature Range:	-55°C to +105°C						
Reliability:	0.5% per 1000 hours at 85°C, V _R 0.1Ω/V series impedance, 60% confidence level Meets requirements of AEC-Q200						

STANDARD NIOBIUM OXIDE CAPACITANCE AND RATED VOLTAGE RANGE (LETTER DENOTES CASE SIZE)

Capacitance		Rated Voltage DC (V _R) to 85°C				
μF	Code	1.8V (x)	2.5V (e)	4V (G)	6.3V (J)	10V (A)
4.7	475				A	A
6.8	685				A	A
10	106				A	A/B
15	156			A	A/B	A/B
22	226		A	A/B	A/B	B/C/B(700)
33	336		A/B	A/B	B/C/B(700)	C
47	476	A	A/B	A/B/C	B/C	C
68	686	B	B/C	B/C	B/C	C
100	107	B/C	B/C	B/C/B(250)	B/C/D/B(400)	D/D(150)
150	157	C	C	C/D	C/D	
220	227	C	C	C/D	C/D/E	
330	337	C	C/D	D	D/E	
470	477		D/E	D/E	E/V/E(75)	
680	687		E	E/V		
1000	108		V	V		

LOW PROFILE NIOBIUM OXIDE CAPACITANCE AND RATED VOLTAGE RANGE (LETTER DENOTES CASE SIZE)

Capacitance		Rated Voltage DC (V _R) to 85°C				
μF	Code	1.8V (x)	2.5V (e)	4V (G)	6.3V (J)	10V (A)
1.0	105					
1.5	155					
2.2	225					P
3.3	335					P
4.7	475				P/S	T
6.8	685			P/S	P/S/T	T
10	106		P/S	P/S/T	P/T	T
15	156	P/S	P/S/T	P/T		
22	226	P/S/T	P/T	T	T	
33	336	T	T	T	W	
47	476	T	T	W	W	
68	686		W	W	X/Y	
100	107	W	W	W/X	F/Y	
150	157		X	Y	F/Y	
220	227	X	Y	F/Y	Y	
330	337	Y	Y	Y		
470	477	Y				

Released ratings (ESR ratings in mOhms in parentheses)

Note: Voltage ratings are minimum values. AVX reserves the right to supply higher voltage ratings in the same case size, to the same reliability standards

RATINGS & PART NUMBER REFERENCE

AVX Part No.	Case Size	Capacitance (µF)	Rated Voltage (V)	Rated Temperature (°C)	Category Voltage (V)	Category Temperature (°C)	DCL Max. (µA)	DF Max. (%)	ESR Max. @ 100kHz (Ω)	100kHz RMS Current (A)			MSL
										25°C	85°C	105°C	
1.8 Volt @ 85°C													
NOJP156M001#WJ	P	15	1.8	85	1.2	105	1.0	10	4.1	0.133	0.119	0.053	1
NOJS156M001#WJ	S	15	1.8	85	1.2	105	1.0	6	2	0.197	0.178	0.079	1
NOJP226M001#WJ	P	22	1.8	85	1.2	105	1.0	10	3.8	0.138	0.124	0.055	1
NOJS226M001#WJ	S	22	1.8	85	1.2	105	1.0	8	1.9	0.203	0.182	0.081	1
NOJT226M001#WJ	T	22	1.8	85	1.2	105	1.0	6	1.8	0.231	0.208	0.092	1
NOJT336M001#WJ	T	33	1.8	85	1.2	105	1.2	6	1.7	0.238	0.214	0.095	1
NOJA476M001#WJ	A	47	1.8	85	1.2	105	1.7	8	1.6	0.237	0.213	0.095	1
NOJB476M001#WJ	B	47	1.8	85	1.2	105	1.7	6	1.6	0.252	0.227	0.101	1
NOJT476M001#WJ	T	47	1.8	85	1.2	105	1.7	10	1.6	0.245	0.220	0.098	1
NOJB686M001#WJ	B	68	1.8	85	1.2	105	2.5	6	1.5	0.261	0.235	0.104	1
NOJB107M001#WJ	B	100	1.8	85	1.2	105	3.6	6	1.4	0.270	0.243	0.108	1
NOJC107M001#WJ	C	100	1.8	85	1.2	105	3.6	6	0.4	0.574	0.517	0.230	1
NOJW107M001#WJ	W	100	1.8	85	1.2	105	3.6	6	0.4	0.520	0.468	0.208	1
NOJC157M001#WJ	C	150	1.8	85	1.2	105	5.4	8	0.4	0.574	0.517	0.230	1
NOJC227M001#WJ	C	220	1.8	85	1.2	105	8.0	8	0.4	0.574	0.517	0.230	1
NOJX227M001#WJ	X	220	1.8	85	1.2	105	8.0	8	0.4	0.548	0.493	0.219	3
NOJC337M001#WJ	C	330	1.8	85	1.2	105	11.9	8	0.3	0.663	0.597	0.265	1
NOJY337M001#WJ	Y	330	1.8	85	1.2	105	11.9	8	0.3	0.707	0.636	0.283	3
NOJY477M001#WJ	Y	470	1.8	85	1.2	105	17.0	8	0.3	0.707	0.636	0.283	3
2.5 Volt @ 85°C													
NOJP106M002#WJ	P	10	2.5	85	1.7	105	1.0	6	4.5	0.126	0.114	0.051	1
NOJS106M002#WJ	S	10	2.5	85	1.7	105	1.0	6	2.2	0.188	0.169	0.075	1
NOJP156M002#WJ	P	15	2.5	85	1.7	105	1.0	6	4	0.134	0.121	0.054	1
NOJS156M002#WJ	S	15	2.5	85	1.7	105	1.0	8	2	0.197	0.178	0.079	1
NOJT156M002#WJ	T	15	2.5	85	1.7	105	1.0	6	2	0.219	0.197	0.088	1
NOJA226M002#WJ	A	22	2.5	85	1.7	105	1.1	6	1.9	0.218	0.196	0.087	1
NOJP226M002#WJ	P	22	2.5	85	1.7	105	1.1	10	3.8	0.138	0.124	0.055	1
NOJT226M002#WJ	T	22	2.5	85	1.7	105	1.1	6	1.9	0.225	0.202	0.090	1
NOJA336M002#WJ	A	33	2.5	85	1.7	105	1.7	6	1.7	0.230	0.207	0.092	1
NOJB336M002#WJ	B	33	2.5	85	1.7	105	1.7	6	1.7	0.245	0.220	0.098	1
NOJT336M002#WJ	T	33	2.5	85	1.7	105	1.7	6	1.7	0.238	0.214	0.095	1
NOJA476M002#WJ	A	47	2.5	85	1.7	105	2.4	8	1.6	0.237	0.213	0.095	1
NOJB476M002#WJ	B	47	2.5	85	1.7	105	2.4	6	1.6	0.252	0.227	0.101	1
NOJT476M002#WJ	T	47	2.5	85	1.7	105	2.4	10	1.6	0.245	0.220	0.098	1
NOJB686M002#WJ	B	68	2.5	85	1.7	105	3.4	6	1.5	0.261	0.235	0.104	1
NOJC686M002#WJ	C	68	2.5	85	1.7	105	3.4	6	0.5	0.514	0.462	0.206	1
NOJW686M002#WJ	W	68	2.5	85	1.7	105	3.4	6	0.4	0.520	0.468	0.208	1
NOJB107M002#WJ	B	100	2.5	85	1.7	105	5.0	6	1.4	0.270	0.243	0.108	1
NOJC107M002#WJ	C	100	2.5	85	1.7	105	5.0	6	0.4	0.574	0.517	0.230	1
NOJW107M002#WJ	W	100	2.5	85	1.7	105	5.0	6	0.4	0.520	0.468	0.208	1
NOJC157M002#WJ	C	150	2.5	85	1.7	105	7.5	6	0.4	0.574	0.517	0.230	1
NOJX157M002#WJ	X	150	2.5	85	1.7	105	7.5	6	0.4	0.548	0.493	0.219	3
NOJC227M002#WJ	C	220	2.5	85	1.7	105	11.0	8	0.4	0.574	0.517	0.230	1
NOJY227M002#WJ	Y	220	2.5	85	1.7	105	11.0	8	0.4	0.612	0.551	0.245	3
NOJC337M002#WJ	C	330	2.5	85	1.7	105	16.5	10	0.3	0.663	0.597	0.265	1
NOJD337M002#WJ	D	330	2.5	85	1.7	105	16.5	10	0.3	0.775	0.697	0.310	3
NOJY337M002#WJ	Y	330	2.5	85	1.7	105	16.5	10	0.3	0.707	0.636	0.283	3
NOJD477M002#WJ	D	470	2.5	85	1.7	105	23.5	12	0.3	0.775	0.697	0.310	3
NOJE477M002#WJ	E	470	2.5	85	1.7	105	23.5	10	0.3	0.812	0.731	0.325	3
NOJE687M002#WJ	E	680	2.5	85	1.7	105	34.0	14	0.3	0.812	0.731	0.325	3
NOJV108M002#WJ	V	1000	2.5	85	1.7	105	50.0	16	0.3	1.000	0.900	0.400	3
4 Volt @ 85°C													
NOJP685M004#WJ	P	6.8	4	85	2.7	105	1.0	6	5.3	0.117	0.105	0.047	1
NOJS685M004#WJ	S	6.8	4	85	2.7	105	1.0	6	2.6	0.173	0.156	0.069	1
NOJP106M004#WJ	P	10	4	85	2.7	105	1.0	20	4.5	0.126	0.114	0.051	1
NOJS106M004#WJ	S	10	4	85	2.7	105	1.0	8	2.2	0.188	0.169	0.075	1
NOJT106M004#WJ	T	10	4	85	2.7	105	1.0	6	2.2	0.209	0.188	0.084	1
NOJA156M004#WJ	A	15	4	85	2.7	105	1.2	6	2	0.212	0.191	0.085	1
NOJP156M004#WJ	P	15	4	85	2.7	105	1.2	10	4.1	0.133	0.119	0.053	1
NOJT156M004#WJ	T	15	4	85	2.7	105	1.2	6	2	0.219	0.197	0.088	1
NOJA226M004#WJ	A	22	4	85	2.7	105	1.8	6	1.9	0.218	0.196	0.087	1
NOJB226M004#WJ	B	22	4	85	2.7	105	1.8	6	1.9	0.232	0.209	0.093	1
NOJT226M004#WJ	T	22	4	85	2.7	105	1.8	6	1.8	0.231	0.208	0.092	1
NOJA336M004#WJ	A	33	4	85	2.7	105	2.6	10	1.7	0.230	0.207	0.092	1
NOJB336M004#WJ	B	33	4	85	2.7	105	2.6	6	1.7	0.245	0.220	0.098	1
NOJT336M004#WJ	T	33	4	85	2.7	105	2.6	14	2	0.219	0.197	0.088	1
NOJA476M004#WJ	A	47	4	85	2.7	105	3.8	18	2.2	0.202	0.182	0.081	1
NOJB476M004#WJ	B	47	4	85	2.7	105	3.8	6	1.6	0.252	0.227	0.101	1
NOJC476M004#WJ	C	47	4	85	2.7	105	3.8	6	0.5	0.514	0.462	0.206	1
NOJW476M004#WJ	W	47	4	85	2.7	105	3.8	6	0.5	0.465	0.418	0.186	1

RATINGS & PART NUMBER REFERENCE

AVX Part No.	Case Size	Capacitance (µF)	Rated Voltage (V)	Rated Temperature (°C)	Category Voltage (V)	Category Temperature (°C)	DCL Max. (µA)	DF Max. (%)	ESR Max. @ 100kHz (Ω)	100kHz RMS Current (A)			MSL
										25°C	85°C	105°C	
NOJB686M004#WJ	B	68	4	85	2.7	105	5.4	6	1.5	0.261	0.235	0.104	1
NOJC686M004#WJ	C	68	4	85	2.7	105	5.4	6	0.5	0.514	0.462	0.206	1
NOJW686M004#WJ	W	68	4	85	2.7	105	5.4	6	0.4	0.520	0.468	0.208	1
NOJB107M004#WJ	B	100	4	85	2.7	105	8.0	16	1.4	0.270	0.243	0.108	1
NOJB107M004#WB	B	100	4	85	2.7	105	8.0	16	0.25	0.639	0.575	0.255	3
NOJC107M004#WJ	C	100	4	85	2.7	105	8.0	6	0.4	0.574	0.517	0.230	1
NOJW107M004#WJ	W	100	4	85	2.7	105	8.0	8	0.4	0.520	0.468	0.208	1
NOJX107M004#WJ	X	100	4	85	2.7	105	8.0	6	0.4	0.548	0.493	0.219	3
NOJC157M004#WJ	C	150	4	85	2.7	105	12.0	6	0.4	0.574	0.517	0.230	1
NOJD157M004#WJ	D	150	4	85	2.7	105	12.0	6	0.3	0.775	0.697	0.310	3
NOJY157M004#WJ	Y	150	4	85	2.7	105	12.0	6	0.4	0.612	0.551	0.245	3
NOJC227M004#WJ	C	220	4	85	2.7	105	17.6	8	0.4	0.574	0.517	0.230	1
NOJD227M004#WJ	D	220	4	85	2.7	105	17.6	8	0.4	0.671	0.604	0.268	3
NOJF227M004#WJ	F	220	4	85	2.7	105	17.6	10	0.4	0.548	0.493	0.219	1
NOJY227M004#WJ	Y	220	4	85	2.7	105	17.6	10	0.4	0.612	0.551	0.245	3
NOJD337M004#WJ	D	330	4	85	2.7	105	26.4	8	0.3	0.775	0.697	0.310	3
NOJY337M004#WJ	Y	330	4	85	2.7	105	26.4	12	0.3	0.707	0.636	0.283	3
NOJD477M004#WJ	D	470	4	85	2.7	105	37.6	12	0.3	0.775	0.697	0.310	3
NOJE477M004#WJ	E	470	4	85	2.7	105	37.6	12	0.3	0.812	0.731	0.325	3
NOJE687M004#WJ	E	680	4	85	2.7	105	54.4	14	0.3	0.812	0.731	0.325	3
NOJV687M004#WJ	V	680	4	85	2.7	105	54.4	14	0.3	1.000	0.900	0.400	3
NOJV108M004#WJ	V	1000	4	85	2.7	105	80.0	18	0.3	1.000	0.900	0.400	3
6.3 Volt @ 85°C													
NOJA475M006#WJ	A	4.7	6.3	85	4	105	1.1	6	3.2	0.168	0.151	0.067	1
NOJP475M006#WJ	P	4.7	6.3	85	4	105	1.0	6	6.1	0.109	0.098	0.043	1
NOJS475M006#WJ	S	4.7	6.3	85	4	105	1.0	6	3.2	0.156	0.141	0.062	1
NOJA685M006#WJ	A	6.8	6.3	85	4	105	1.1	6	2.6	0.186	0.167	0.074	1
NOJP685M006#WJ	P	6.8	6.3	85	4	105	1.0	10	5.2	0.118	0.106	0.047	1
NOJS685M006#WJ	S	6.8	6.3	85	4	105	1.0	8	2.7	0.170	0.153	0.068	1
NOJT685M006#WJ	T	6.8	6.3	85	4	105	1.0	6	2.6	0.192	0.173	0.077	1
NOJA106M006#WJ	A	10	6.3	85	4	105	1.2	6	2.2	0.202	0.182	0.081	1
NOJP106M006#WJ	P	10	6.3	85	4	105	1.2	10	4.5	0.126	0.114	0.051	1
NOJT106M006#WJ	T	10	6.3	85	4	105	1.2	6	2.2	0.209	0.188	0.084	1
NOJA156M006#WJ	A	15	6.3	85	4	105	1.8	8	2	0.212	0.191	0.085	1
NOJB156M006#WJ	B	15	6.3	85	4	105	1.8	6	2	0.226	0.203	0.090	1
NOJA226M006#WJ	A	22	6.3	85	4	105	2.6	8	1.8	0.224	0.201	0.089	1
NOJB226M006#WJ	B	22	6.3	85	4	105	2.6	6	1.9	0.232	0.209	0.093	1
NOJT226M006#WJ	T	22	6.3	85	4	105	2.6	8	1.8	0.231	0.208	0.092	1
NOJB336M006#WJ	B	33	6.3	85	4	105	4.0	6	1.7	0.245	0.220	0.098	1
NOJB336M006#WB	B	33	6.3	85	4	105	4.0	6	0.7	0.382	0.344	0.153	3
NOJC336M006#WJ	C	33	6.3	85	4	105	4.0	6	0.5	0.514	0.462	0.206	1
NOJW336M006#WJ	W	33	6.3	85	4	105	4.0	6	0.5	0.465	0.418	0.186	1
NOJB476M006#WJ	B	47	6.3	85	4	105	5.6	6	0.8	0.357	0.321	0.143	1
NOJC476M006#WJ	C	47	6.3	85	4	105	5.7	6	0.5	0.514	0.462	0.206	1
NOJW476M006#WJ	W	47	6.3	85	4	105	5.7	6	0.5	0.465	0.418	0.186	1
NOJB686M006#WJ	B	68	6.3	85	4	105	8.2	20	1.5	0.261	0.235	0.104	1
NOJC686M006#WJ	C	68	6.3	85	4	105	8.2	6	0.5	0.514	0.462	0.206	1
NOJX686M006#WJ	X	68	6.3	85	4	105	8.2	6	0.5	0.490	0.441	0.196	3
NOJY686M006#WJ	Y	68	6.3	85	4	105	8.2	6	0.5	0.548	0.493	0.219	3
NOJB107M006#WJ	B	100	6.3	85	4	105	60.0	20	1.7	0.245	0.220	0.098	1
NOJB107M006#WB	B	100	6.3	85	4	105	60.0	20	0.4	0.505	0.454	0.202	3
NOJC107M006#WJ	C	100	6.3	85	4	105	12.0	8	0.4	0.574	0.517	0.230	1
NOJD107M006#WJ	D	100	6.3	85	4	105	12.0	6	0.4	0.671	0.604	0.268	3
NOJF107M006#WJ	F	100	6.3	85	4	105	12	8	0.4	0.548	0.493	0.219	1
NOJY107M006#WJ	Y	100	6.3	85	4	105	12.0	6	0.4	0.612	0.551	0.245	3
NOJC157M006#WJ	C	150	6.3	85	4	105	18.0	6	0.4	0.574	0.517	0.230	1
NOJD157M006#WJ	D	150	6.3	85	4	105	18.0	6	0.4	0.671	0.604	0.268	3
NOJF157M006#WJ	F	150	6.3	85	4	105	18.0	8	0.4	0.548	0.493	0.219	1
NOJY157M006#WJ	Y	150	6.3	85	4	105	18.0	6	0.4	0.612	0.551	0.245	3
NOJC227M006#WJ	C	220	6.3	85	4	105	26.4	14	0.4	0.574	0.517	0.230	1
NOJD227M006#WJ	D	220	6.3	85	4	105	26.4	8	0.4	0.671	0.604	0.268	3
NOJE227M006#WJ	E	220	6.3	85	4	105	26.4	12	0.4	0.704	0.633	0.281	3
NOJY227M006#WJ	Y	220	6.3	85	4	105	26.4	10	0.4	0.612	0.551	0.245	3
NOJD337M006#WJ	D	330	6.3	85	4	105	39.6	10	0.3	0.775	0.697	0.310	3
NOJE337M006#WJ	E	330	6.3	85	4	105	39.6	12	0.3	0.812	0.731	0.325	3
NOJE477M006#WJ	E	470	6.3	85	4	105	56.4	16	0.3	0.812	0.731	0.325	3
NOJE477M006#WB	E	470	6.3	85	4	105	56.4	16	0.075	1.625	1.462	0.650	3
NOJV477M006#WJ	V	470	6.3	85	4	105	56.4	14	0.3	1.000	0.900	0.400	3

OxiCap® NOJ Series

Standard and Low Profile Niobium Oxide Capacitors



RATINGS & PART NUMBER REFERENCE

AVX Part No.	Case Size	Capacitance (µF)	Rated Voltage (V)	Rated Temperature (°C)	Category Voltage (V)	Category Temperature (°C)	DCL Max. (µA)	DF Max. (%)	ESR Max. @ 100kHz (Ω)	100kHz RMS Current (A)			MSL
										25°C	85°C	105°C	
10 Volt @ 85°C													
NOJP225M010#WJ	P	2.2	10	85	7	105	1.0	8	8.3	0.093	0.084	0.037	1
NOJP335M010#WJ	P	3.3	10	85	7	105	1.0	8	7	0.101	0.091	0.041	1
NOJA475M010#WJ	A	4.7	10	85	7	105	1.0	6	3.1	0.170	0.153	0.068	1
NOJT475M010#WJ	T	4.7	10	85	7	105	1.0	6	3.1	0.176	0.158	0.070	1
NOJA685M010#WJ	A	6.8	10	85	7	105	1.4	6	2.6	0.186	0.167	0.074	1
NOJT685M010#WJ	T	6.8	10	85	7	105	1.4	6	2.6	0.192	0.173	0.077	1
NOJA106M010#WJ	A	10	10	85	7	105	2.0	6	2.2	0.202	0.182	0.081	1
NOJB106M010#WJ	B	10	10	85	7	105	2.0	6	1	0.319	0.287	0.128	1
NOJT106M010#WJ	T	10	10	85	7	105	2.0	6	2.2	0.209	0.188	0.084	1
NOJA156M010#WJ	A	15	10	85	7	105	3.0	6	2	0.212	0.191	0.085	1
NOJB156M010#WJ	B	15	10	85	7	105	3.0	6	2	0.226	0.203	0.090	1
NOJB226M010#WJ	B	22	10	85	7	105	4.4	6	1.8	0.238	0.214	0.095	1
NOJB226M010#WB	B	22	10	85	7	105	4.4	6	0.7	0.382	0.344	0.153	3
NOJC226M010#WJ	C	22	10	85	7	105	4.4	6	0.5	0.514	0.462	0.206	1
NOJC336M010#WJ	C	33	10	85	7	105	6.6	6	0.5	0.514	0.462	0.206	1
NOJC476M010#WJ	C	47	10	85	7	105	9.4	6	0.4	0.574	0.517	0.230	1
NOJC686M010#WJ	C	68	10	85	7	105	13.6	12	0.5	0.514	0.462	0.206	1
NOJD107M010#WJ	D	100	10	85	7	105	20.0	12	0.4	0.671	0.604	0.268	3
NOJD107M010#WB	D	100	10	85	7	105	20.0	12	0.15	1.095	0.986	0.438	3

Moisture Sensitivity Level (MSL) is defined according to J-STD-020.

All technical data relates to an ambient temperature of +25°C. Capacitance and DF are measured at 120Hz, 0.5V RMS with a maximum DC bias of 2.2 volts. DCL is measured at rated voltage after 5 minutes.

The EIA & CECC standards for capacitors allow an ESR movement to 1.25 times catalog limit post mounting.

For typical weight and composition see page 274.

NOTE: AVX reserves the right to supply higher voltage ratings in the same case size, to the same reliability standards.

QUALIFICATION TABLE

TEST	NOJ series (Temperature range -55°C to +105°C)									
	Condition			Characteristics						
Endurance	Apply rated voltage (Ur) at 85°C and / or category voltage (Uc) at 105°C for 2000 hours through a circuit impedance of $\leq 0.1\Omega/V$. Stabilize at room temperature for 1-2 hours before measuring.			Visual examination	no visible damage					
				DCL	initial limit					
				$\Delta C/C$	within $\pm 10\%$ of initial value					
				DF	initial limit					
				ESR	1.25 x initial limit					
Storage Life	Store at 105°C, no voltage applied, for 2000 hours. Stabilize at room temperature for 1-2 hours before measuring.			Visual examination	no visible damage					
				DCL	initial limit					
				$\Delta C/C$	within $\pm 10\%$ of initial value					
				DF	initial limit					
				ESR	1.25 x initial limit					
Humidity	Store at 65°C and 95% relative humidity for 500 hours, with no applied voltage. Stabilize at room temperature and humidity for 1-2 hours before measuring.			Visual examination	no visible damage					
				DCL	1.5 x initial limit					
				$\Delta C/C$	within $\pm 10\%$ of initial value					
				DF	1.2 x initial limit					
				ESR	1.25 x initial limit					
Biased Humidity	Apply rated voltage (Ur) at 85°C, 85°C relative humidity for 1000 hours. Stabilize at room temperature and humidity for 1-2 hours before measuring.			Visual examination	no visible damage					
				DCL	2 x initial limit					
				$\Delta C/C$	within $\pm 10\%$ of initial value					
				DF	1.2 x initial limit					
				ESR	1.25 x initial limit					
Temperature Stability	Step	Temperature°C	Duration(min)		+20°C	-55°C	+20°C	+85°C	+105°C	+20°C
	1	+20	15	DCL	IL*	n/a	IL*	10x IL*	12.5x IL*	IL*
	2	-55	15	$\Delta C/C$	n/a	+0/-10%	$\pm 5\%$	+10/-0%	+12/-0%	$\pm 5\%$
	3	+20	15	DF	IL*	1.5x IL*	IL*	1.5x IL*	2x IL*	IL*
	4	+85	15	ESR	1.25x IL*	2.5x IL*	1.25x IL*	1.25x IL*	1.25x IL*	1.25x IL*
	5	+105	15							
	6	+20	15							
Surge Voltage	Apply 1.3x category voltage (Uc) at 105°C for 1000 cycles of duration 6 min (30 sec charge, 5 min 30 sec discharge) through a charge / discharge resistance of 1000 Ω			Visual examination	no visible damage					
				DCL	initial limit					
				$\Delta C/C$	within $\pm 5\%$ of initial value					
				DF	initial limit					
				ESR	1.25 x initial limit					
Mechanical Shock	MIL-STD-202, Method 213, Condition F			Visual examination	no visible damage					
				DCL	initial limit					
				$\Delta C/C$	within $\pm 5\%$ of initial value					
				DF	initial limit					
				ESR	1.25 x initial limit					
Vibration	MIL-STD-202, Method 204, Condition D			Visual examination	no visible damage					
				DCL	initial limit					
				$\Delta C/C$	within $\pm 5\%$ of initial value					
				DF	initial limit					
				ESR	1.25 x initial limit					

*Initial Limit

SOLID ELECTROLYTIC CAPACITOR ROADMAP

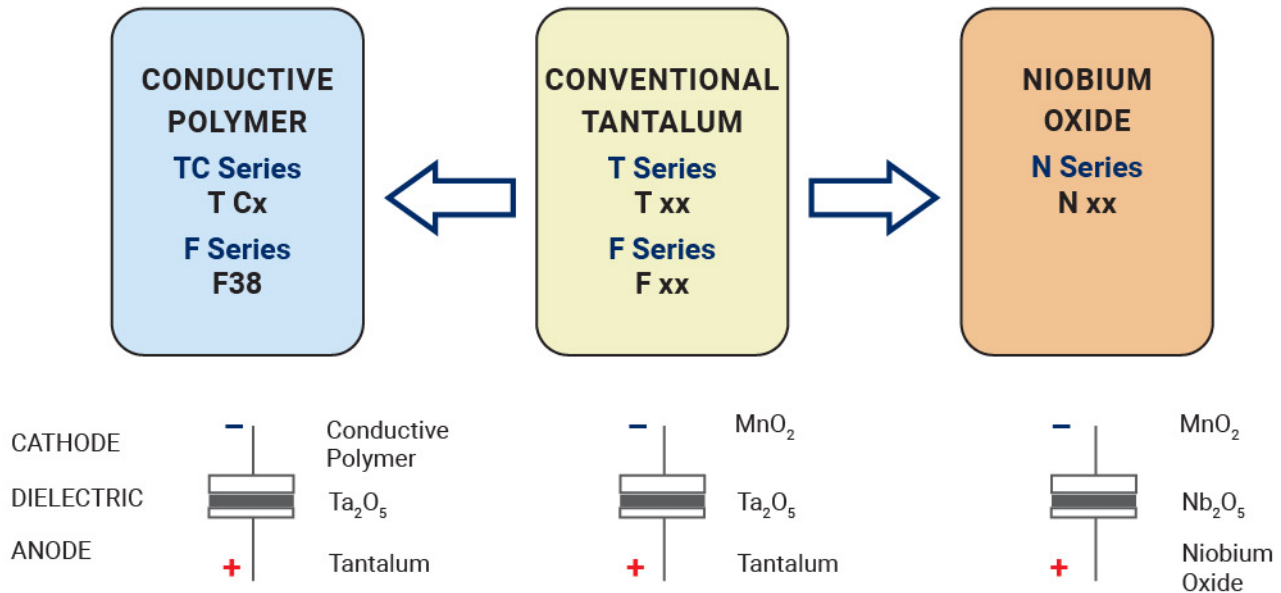

FIVE CAPACITOR CONSTRUCTION STYLES

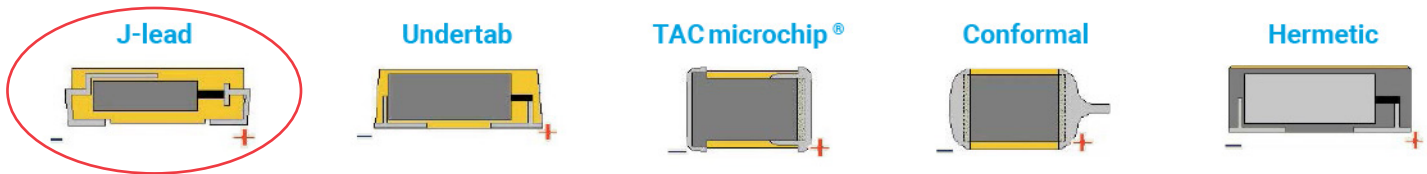

SERIES LINE UP : NIOBIUM OXIDE OxiCap® CAPACITORS

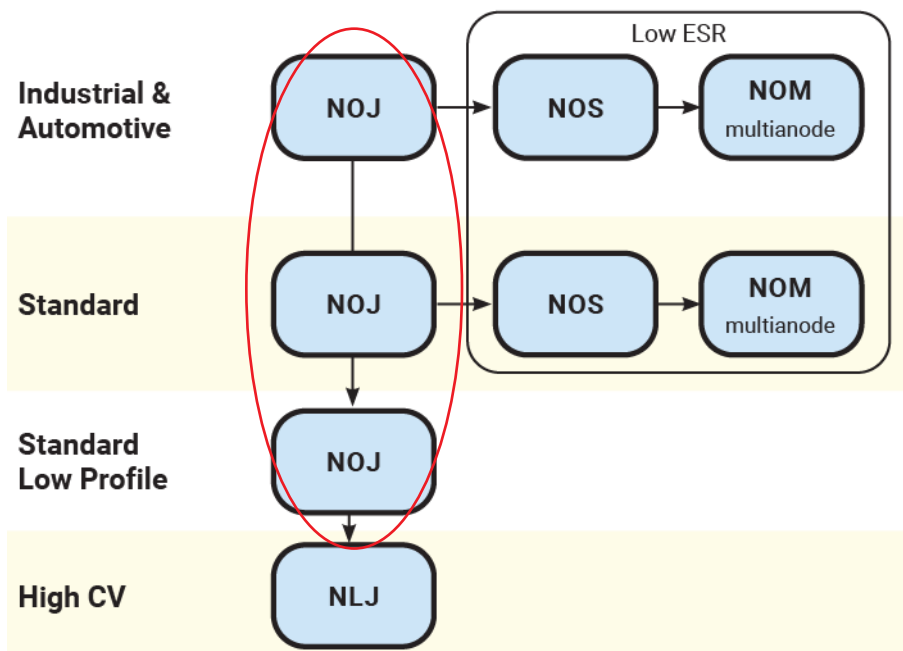

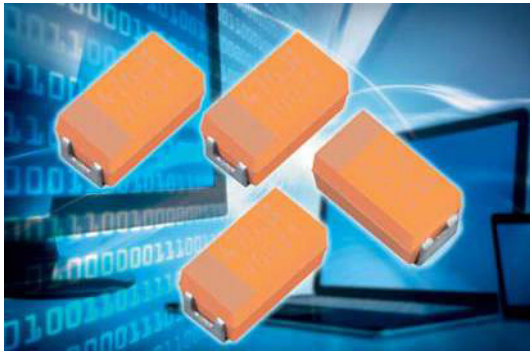

FEATURES

- High Volumetric Efficiency
- Environmentally Friendly
- 3x Reflow 260°C Compatible
- 100% Surge Current Tested
- Consumer Applications
- OxiCap® Non-Burn Technology
- RoHS Compliance
- Lead-Free Solution
- 6 Case Sizes Available
- CV Range: 22-150µF / 4-10V

APPLICATIONS

- Consumer Handhelds and Entertainment



LEAD-FREE

LEAD-FREE COMPATIBLE COMPONENT



ROHS COMPLIANT



NON-BURN
NON-SMOKE



Elektra Award
2005

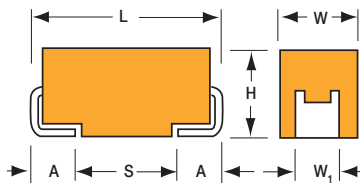

CASE DIMENSIONS:

millimeters (inches)

Code	EIA Code	EIA Metric	L±0.20 (0.008)	W+0.20 (0.008) -0.10 (0.004)	H+0.20 (0.008) -0.10 (0.004)	W ₁ ±0.20 (0.008)	A+0.30 (0.012) -0.20 (0.008)	S Min.
A	1206	3216-18	3.20 (0.126)	1.60 (0.063)	1.60 (0.063)	1.20 (0.047)	0.80 (0.031)	1.10 (0.043)
B	1210	3528-21	3.50 (0.138)	2.80 (0.110)	1.90 (0.075)	2.20 (0.087)	0.80 (0.031)	1.40 (0.055)
G	1206	3216-15	3.20 (0.126)	1.60 (0.063)	1.50 (0.059) max	1.20 (0.047)	0.80 (0.031)	1.10 (0.043)
P	0805	2012-15	2.05 (0.081)	1.35 (0.053)	1.50 (0.059) max	1.00±0.10 (0.039±0.004)	0.50 (0.020)	0.85 (0.033)
S	1206	3216-12	3.20 (0.126)	1.60 (0.063)	1.20 (0.047) max	1.20 (0.047)	0.80 (0.031)	1.10 (0.043)
T	1210	3528-12	3.50 (0.138)	2.80 (0.110)	1.20 (0.047) max	2.20 (0.087)	0.80 (0.031)	1.40 (0.055)

W₁ dimension applies to the termination width for A dimensional area only.

MARKING

A, B, G, S, T CASE

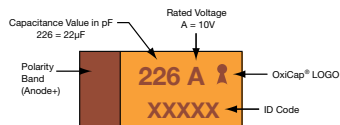

P CASE

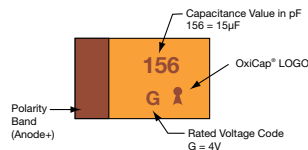

HOW TO ORDER



TECHNICAL SPECIFICATIONS

Technical Data:	All technical data relate to an ambient temperature of +25°C				
Capacitance Range:	22 µF to 150 µF				
Capacitance Tolerance:	±20%				
Leakage Current DCL:	0.1CV				
Rated Voltage (V _R)	-55°C ≤ +40°C:	4	6.3	10	
Category Voltage (V _C)	at 85°C:	2	3.2	5	
Category Voltage (V _C)	at 105°C:	1.3	2	3.3	
Temperature Range:	-55°C to +105°C with category voltage				
Reliability:	0.2% per 1000 hours at 85°C, 0.5xV _R , 0.1Ω/V series impedance with 60% confidence level				

CAPACITANCE AND RATED VOLTAGE RANGE (LETTER DENOTES CASE SIZE)

Capacitance		Rated Voltage DC to 40°C		
µF	Code	4V (G)	6.3V (J)	10V (A)
22	226	P(4000)	S(1800)	A(4000)/G(3000)
33	336		G(2200)	A(1700)
47	476		A(1600)/T(1600)	B(1000)
68	686			
100	107		B(1700)	
150	157	B(1500)		

Released ratings, (ESR ratings in mOhms in parentheses)

Note: Voltage ratings are minimum values. AVX reserves the right to supply higher voltage ratings in the same case size, to the same reliability standards.

RATINGS & PART NUMBER REFERENCE

AVX Part No.	Case Size	Capacitance (µF)	Rated Voltage (V)	Rated Temperature (°C)	Category Voltage (V)	Category Temperature (°C)	Maximum Surge Current (A)	DCL Max. (µA)	ESR Max. @100kHz (mΩ)	100kHz RMS Current (mA)			MSL
										25°C	85°C	105°C	
4 Volt @ 85°C													
NLJP226M004#4000	P	22	4	85	1.3	105	0.4	8.8	4000	134	121	54	3
NLJB157M004#1500	B	150	4	85	1.3	105	1.0	60.0	1500	261	235	104	3
6.3 Volt @ 85°C													
NLJS226M006#1800	S	22	6.3	85	2	105	1.4	13.2	1800	208	187	83	3
NLJG336M006#2200	G	33	6.3	85	2	105	1.2	19.8	2200	195	176	78	3
NLJA476M006#1600	A	47	6.3	85	2	105	1.5	28.2	1600	237	213	98	3
NLJT476M006#1600	T	47	6.3	85	2	105	1.5	28.2	1600	245	220	98	3
NLJB107M006#1700	B	100	6.3	85	2	105	1.5	60.0	1700	245	220	98	3
10 Volt @ 85°C													
NLJA226M010#4000	A	22	10	85	3.3	105	1.1	22.0	4000	150	135	60	3
NLJG226M010#3000	G	22	10	85	3.3	105	1.4	22.0	3000	167	151	67	3
NLJA336M010#1700	A	33	10	85	3.3	105	2.3	33.0	1700	230	207	92	3
NLJB476M010#1000	B	47	10	85	3.3	105	3.4	47.0	1000	319	287	128	3

Moisture Sensitivity Level (MSL) is defined according to J-STD-020.

All technical data relates to an ambient temperature of +25°C. Capacitance and DF are measured at 120Hz, 0.5V

RMS with a maximum DC bias of 2.2 volts. DCL is measured at rated voltage after 5 minutes.

ESR allowed to move up to 1.25 times catalogue limit post mounting

DCL allowed to move up to 2.00 times catalogue limit post mounting

For typical weight and composition see page 274.

NOTE: AVX reserves the right to supply higher voltage ratings or tighter tolerance part in the same case size, to the same reliability standards.

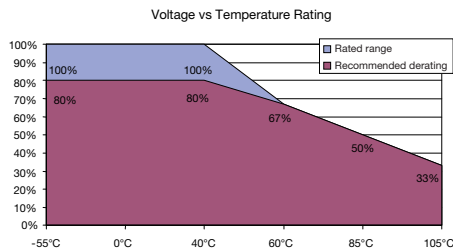

QUALIFICATION TABLE

TEST	NLJ series (Temperature range -55°C to +105°C)										
	Condition			Characteristics							
Endurance	Apply rated voltage (Ur) at 40°C and / or category voltage (Uc) at 85°C for 2000 hours through a circuit impedance of $\leq 0.1\Omega/V$. Stabilize at room temperature for 1-2 hours before measuring.			Visual examination	no visible damage						
				DCL	2 x initial limit						
				$\Delta C/C$	within $\pm 10\%$ of initial value						
				ESR	1.25 x initial limit						
Humidity	Store at 65°C and 90-95% relative humidity for 500 hours, with no applied voltage. Stabilize at room temperature and humidity for 1-2 hours before measuring.			Visual examination	no visible damage						
				DCL	2 x initial limit						
				$\Delta C/C$	within $\pm 10\%$ of initial value						
				ESR	1.25 x initial limit						
Temperature Stability	Step	Temperature°C	Duration(min)		+20°C	-55°C	+20°C	+85°C	+105°C	+20°C	
	1	+20	15	DCL	2 x IL*	n/a	2 x IL**	10 x IL*	12.5 x IL*	2 x IL*	
	2	-55	15		$\Delta C/C$	n/a	+0/-20%	$\pm 5\%$	+20/-0%	+25/-0%	$\pm 5\%$
	3	+20	15	ESR		1.25 x IL*	2.5 x IL*	1.25 x IL*	1.25 x IL*	1.25 x IL*	1.25 x IL*
	4	+85	15								
	5	+105	15								
	6	+20	15								
Surge Voltage	Apply 1.3x rated voltage (Ur) at 40°C for 1000 cycles of duration 6 min (30 sec charge, 5 min 30 sec discharge) through a charge / discharge resistance of 1000 Ω			Visual examination	no visible damage						
				DCL	2 x initial limit						
				$\Delta C/C$	within $\pm 5\%$ of initial value						
				ESR	1.25 x initial limit						
Mechanical Shock	MIL-STD-202, Method 213, Condition C			Visual examination	no visible damage						
				DCL	initial limit						
				$\Delta C/C$	within $\pm 5\%$ of initial value						
				DF	initial limit						
				ESR	initial limit						
Vibration	MIL-STD-202, Method 204, Condition D			Visual examination	no visible damage						
				DCL	initial limit						
				$\Delta C/C$	within $\pm 5\%$ of initial value						
				DF	initial limit						
				ESR	initial limit						

*Initial Limit

AVX SOLID ELECTROLYTIC CAPACITOR ROADMAP

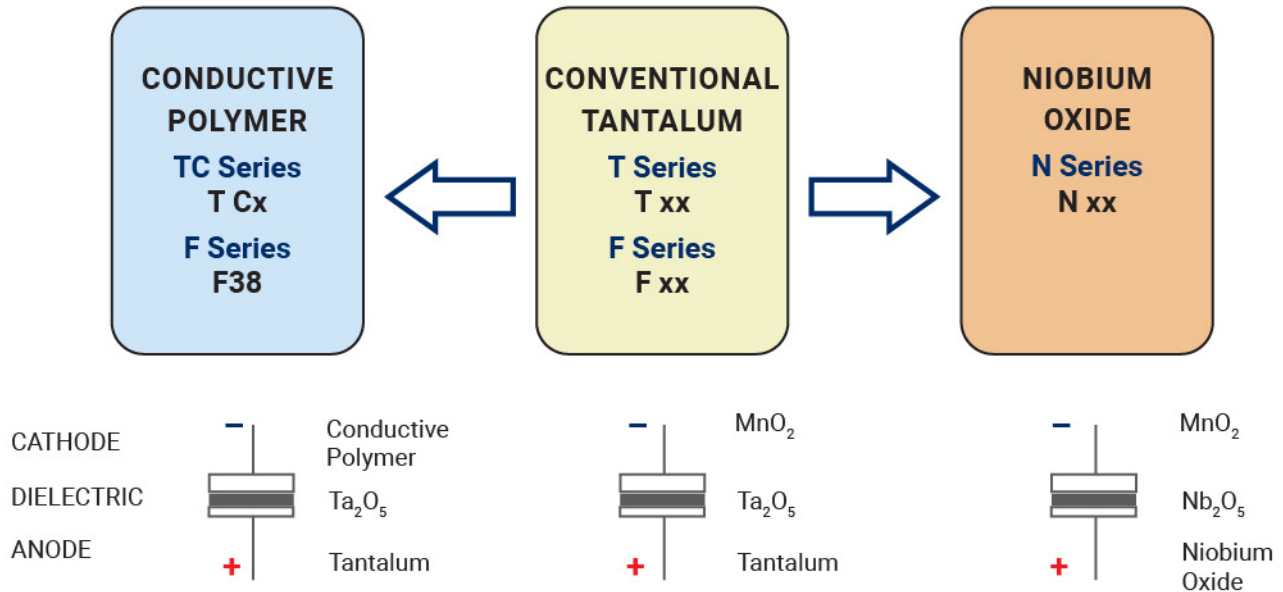

FIVE CAPACITOR CONSTRUCTION STYLES

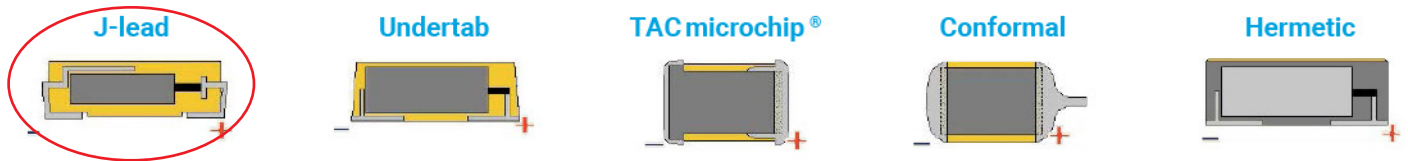

SERIES LINE UP : NIOBIUM OXIDE OxiCap® CAPACITORS

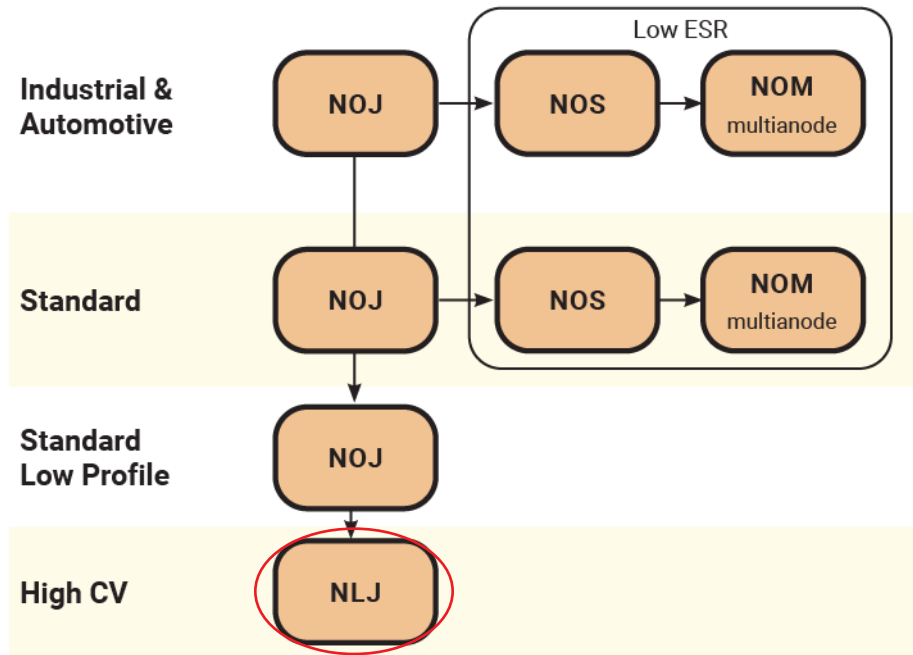

OxiCap® NOS Low ESR Series

Niobium Oxide Capacitor



FEATURES

- Low ESR NbO Capacitors
- Non-Burn Safe Technology
- Reliability Level: 0.2%/1000 hrs.
- 100% Surge Current Tested
- CV Range: 10-1000µF / 1.8-8V
- 9 Case Sizes Available
- IBM Global Approval Received in 2004
- Elektra Award Received in 2005
- Meets Requirements of AEC-Q200
- -55 to +125°C Operation Temperature



Elektra Award
2005

APPLICATIONS

- Medium Power DC/DC for Transportation and Automotive Industry

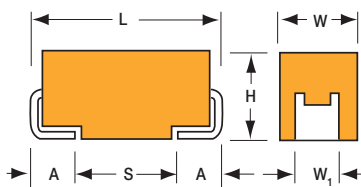

CASE DIMENSIONS:

millimeters (inches)

Code	EIA Code	EIA Metric	L±0.20 (0.008)	W+0.20 (0.008) -0.10 (0.004)	H+0.20 (0.008) -0.10 (0.004)	W ₁ ±0.20 (0.008)	A+0.30 (0.012) -0.20 (0.008)	S Min.
A	1206	3216-18	3.20 (0.126)	1.60 (0.063)	1.60 (0.063)	1.20 (0.047)	0.80 (0.031)	1.10 (0.043)
B	1210	3528-21	3.50 (0.138)	2.80 (0.110)	1.90 (0.075)	2.20 (0.087)	0.80 (0.031)	1.40 (0.055)
C	2312	6032-28	6.00 (0.236)	3.20 (0.126)	2.60 (0.102)	2.20 (0.087)	1.30 (0.051)	2.90 (0.114)
D	2917	7343-31	7.30 (0.287)	4.30 (0.169)	2.90 (0.114)	2.40 (0.094)	1.30 (0.051)	4.40 (0.173)
E	2917	7343-43	7.30 (0.287)	4.30 (0.169)	4.10 (0.162)	2.40 (0.094)	1.30 (0.051)	4.40 (0.173)
V	2924	7361-38	7.30 (0.287)	6.10 (0.240)	3.55 (0.140)	3.10 (0.122)	1.30 (0.051)	4.40 (0.173)
W	2312	6032-15	6.00 (0.236)	3.20 (0.126)	1.50 (0.059) max.	2.20 (0.087)	1.30 (0.051)	2.90 (0.114)
X	2917	7343-15	7.30 (0.287)	4.30 (0.169)	1.50 (0.059) max.	2.40 (0.094)	1.30 (0.051)	4.40 (0.173)
Y	2917	7343-20	7.30 (0.287)	4.30 (0.169)	2.00 (0.079) max.	2.40 (0.094)	1.30 (0.051)	4.40 (0.173)

W₁ dimension applies to the termination width for A dimensional area only.

MARKING

A, B, C, D, E, V, W, X, Y
CASE

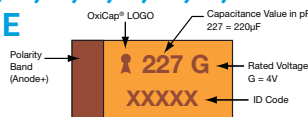

HOW TO ORDER

NOS

Type

D

Case Size
See table above

107

Capacitance Code
1st two digits represent significant figures, 3rd digit represents multiplier in pF

M

Tolerance
M = ±20%

006

Rated DC Voltage
001 = 1.8Vdc
002 = 2.5Vdc
004 = 4Vdc
006 = 6.3Vdc
008 = 8Vdc

R

Packaging
R = Pure Tin 7" Reel
S = Pure Tin 13" Reel

0100

ESR in mΩ

-

Additional characters may be added for special requirements
V = Dry pack Option (selected codes only) with exception of D, E, X, Y, V cases

TECHNICAL SPECIFICATIONS

Technical Data:	All technical data relate to an ambient temperature of +25°C is not stated						
Capacitance Range:	10 µF to 1000 µF						
Capacitance Tolerance:	±20%						
Leakage Current DCL:	0.02CV						
Rated Voltage DC (V _R)	≤ +85°C:	1.8	2.5	4	6.3	8	
Category Voltage (V _C)	≤ +105°C:	1.2	1.7	2.7	4	7	
Category Voltage (V _C)	≤ +125°C:	0.9	1.3	2	3	4	
Surge Voltage (V _S)	≤ +85°C:	2.3	3.3	5.2	8	10	
Surge Voltage (V _S)	≤ +105°C:	1.6	2.2	3.4	5	8	
Surge Voltage (V _S)	≤ +125°C:	1.2	1.7	2.6	4	5.3	
Temperature Range:	-55°C to +125°C						
Reliability:	0.2% per 1000 hours at 85°C, V _R 0.1Ω/V series impedance, 60% confidence level Meets requirements of AEC-Q200						

OxiCap® NOS Low ESR Series

Niobium Oxide Capacitor



CAPACITANCE AND RATED VOLTAGE RANGE (LETTER DENOTES CASE SIZE)

Capacitance		Rated Voltage DC (V _R) to 85°C				
μF	Code	1.8V (x)	2.5V (e)	4.0V (G)	6.3V (J)	8V (P)
10	106				A(800,1000,2000,2200)	A(2200) B(1000)
15	156			A(1500,2000)	B(600,2000)	B(1000)
22	226		A(900,1900)	B(600,1900)	B(600,1900)	B(700,1800) C(500)
33	336		B(1700)	B(600,1700)	B(600,1700) C(500) W(250,500)	C(500)
47	476		B(500,1600)	B(500,1600) C(300,500) W(150,500)	B(500,800) C(300,500)	C(400)
68	686		C(200,500) W(150,400)	C(200,500)	C(75,200,500) X(100,500) Y(100,500)	C(500)
100	107	B(350,1400) W(150,400)	C(150,400)	C(70,150,400) X(100,400)	C(150,400) D(80,100,400) Y(100,400)	D(400)
150	157	C(400)	C(65,150,400) X(100,400)	C(90,150,400) Y(100,400)	D(50,70,100,400) Y(100,400)	
220	227	C(125,400) X(100,400)	C(80,125,400) Y(100,400)	D(40,60,100,400) Y(100,400)	D(45,60,100,400) E(80,100,400)	
330	337	Y(100,300)	D(35,50,100,300) Y(100,300)	D(35,55,100,300) E(100) Y(150,300)	E(80,100,300)	
470	477	Y(100,300)	D(35,55,100,300) E(100,300)	D(100,300) E(75,100,300)	V(75,300)	
680	687		E(60,300)	V(75,300)		
1000	108		V(50,300)			

Released ratings (ESR ratings in mOhms in parentheses)

Note: Voltage ratings are minimum values. AVX reserves the right to supply higher voltage ratings in the same case size, to the same reliability standards.

OxiCap® NOS Low ESR Series

Niobium Oxide Capacitor



RATINGS & PART NUMBER REFERENCE

AVX Part No.	Case Size	Capacitance (µF)	Rated Voltage (V)	Rated Temperature (°C)	Category Voltage (V)	Category Temperature (°C)	DCL Max. (µA)	DF Max. (%)	ESR Max. @ 100kHz (mΩ)	100kHz RMS Current (A)			MSL
										25°C	85°C	125°C	
1.8 Volt @ 85°C													
NOSB107M001#0350	B	100	1.8	85	0.9	125	3.6	6	350	0.540	0.486	0.216	1
NOSB107M001#1400	B	100	1.8	85	0.9	125	3.6	6	1400	0.270	0.243	0.108	1
NOSW107M001#0150	W	100	1.8	85	0.9	125	3.6	6	150	0.849	0.764	0.339	1
NOSW107M001#0400	W	100	1.8	85	0.9	125	3.6	6	400	0.520	0.468	0.208	1
NOSC157M001#0400	C	150	1.8	85	0.9	125	5.4	8	400	0.574	0.517	0.230	1
NOSC227M001#0125	C	220	1.8	85	0.9	125	8.0	8	125	1.028	0.925	0.411	1
NOSC227M001#0400	C	220	1.8	85	0.9	125	8.0	8	400	0.574	0.517	0.230	1
NOSX227M001#0100	X	220	1.8	85	0.9	125	8.0	8	100	1.095	0.986	0.438	3
NOSX227M001#0400	X	220	1.8	85	0.9	125	8.0	8	400	0.548	0.493	0.219	3
NOSY337M001#0100	Y	330	1.8	85	0.9	125	11.9	8	100	1.225	1.102	0.490	3
NOSY337M001#0300	Y	330	1.8	85	0.9	125	11.9	8	300	0.707	0.636	0.283	3
NOSY477M001#0100	Y	470	1.8	85	0.9	125	17.0	8	100	1.225	1.102	0.490	3
NOSY477M001#0300	Y	470	1.8	85	0.9	125	17.0	8	300	0.707	0.636	0.283	3
2.5 Volt @ 85°C													
NOSA226M002#0900	A	22	2.5	85	1.3	125	1.1	6	900	0.316	0.285	0.126	1
NOSA226M002#1900	A	22	2.5	85	1.3	125	1.1	6	1900	0.218	0.196	0.087	1
NOSB336M002#1700	B	33	2.5	85	1.3	125	1.7	6	1700	0.245	0.220	0.098	1
NOSB476M002#0500	B	47	2.5	85	1.3	125	2.4	6	500	0.452	0.406	0.181	1
NOSB476M002#1600	B	47	2.5	85	1.3	125	2.4	6	1600	0.252	0.227	0.101	1
NOSC686M002#0200	C	68	2.5	85	1.3	125	3.4	6	200	0.812	0.731	0.325	1
NOSC686M002#0500	C	68	2.5	85	1.3	125	3.4	6	500	0.514	0.462	0.206	1
NOSW686M002#0150	W	68	2.5	85	1.3	125	3.4	6	150	0.849	0.764	0.339	1
NOSW686M002#0400	W	68	2.5	85	1.3	125	3.4	6	400	0.520	0.468	0.208	1
NOSC107M002#0150	C	100	2.5	85	1.3	125	5.0	6	150	0.938	0.844	0.375	1
NOSC107M002#0400	C	100	2.5	85	1.3	125	5.0	6	400	0.574	0.517	0.230	1
NOSC157M002#0065	C	150	2.5	85	1.3	125	7.5	6	65	1.425	1.283	0.570	1
NOSC157M002#0150	C	150	2.5	85	1.3	125	7.5	6	150	0.938	0.844	0.375	1
NOSC157M002#0400	C	150	2.5	85	1.3	125	7.5	6	400	0.574	0.517	0.230	1
NOSX157M002#0100	X	150	2.5	85	1.3	125	7.5	6	100	1.095	0.986	0.438	3
NOSX157M002#0400	X	150	2.5	85	1.3	125	7.5	6	400	0.548	0.493	0.219	3
NOSC227M002#0080	C	220	2.5	85	1.3	125	11.0	8	80	1.285	1.156	0.514	1
NOSC227M002#0125	C	220	2.5	85	1.3	125	11.0	8	125	1.028	0.925	0.411	1
NOSC227M002#0400	C	220	2.5	85	1.3	125	11.0	8	400	0.574	0.517	0.230	1
NOSY227M002#0100	Y	220	2.5	85	1.3	125	11.0	8	100	1.225	1.102	0.490	3
NOSY227M002#0400	Y	220	2.5	85	1.3	125	11.0	8	400	0.612	0.551	0.245	3
NOSD337M002#0035	D	330	2.5	85	1.3	125	16.5	10	35	2.268	2.041	0.907	3
NOSD337M002#0050	D	330	2.5	85	1.3	125	16.5	10	50	1.897	1.708	0.759	3
NOSD337M002#0100	D	330	2.5	85	1.3	125	16.5	10	100	1.342	1.207	0.537	3
NOSD337M002#0300	D	330	2.5	85	1.3	125	16.5	10	300	0.775	0.697	0.310	3
NOSY337M002#0100	Y	330	2.5	85	1.3	125	16.5	10	100	1.225	1.102	0.490	3
NOSY337M002#0300	Y	330	2.5	85	1.3	125	16.5	10	300	0.707	0.636	0.283	3
NOSD477M002#0035	D	470	2.5	85	1.3	125	23.5	12	35	2.268	2.041	0.907	3
NOSD477M002#0055	D	470	2.5	85	1.3	125	23.5	12	55	1.809	1.628	0.724	3
NOSD477M002#0100	D	470	2.5	85	1.3	125	23.5	12	100	1.342	1.207	0.537	3
NOSD477M002#0300	D	470	2.5	85	1.3	125	23.5	12	300	0.775	0.697	0.310	3
NOSE477M002#0100	E	470	2.5	85	1.3	125	23.5	10	100	1.407	1.266	0.563	3
NOSE477M002#0300	E	470	2.5	85	1.3	125	23.5	10	300	0.812	0.731	0.325	3
NOSE687M002#0060	E	680	2.5	85	1.3	125	34.0	14	60	1.817	1.635	0.727	3
NOSE687M002#0300	E	680	2.5	85	1.3	125	34.0	14	300	0.812	0.731	0.325	3
NOSV108M002#0050	V	1000	2.5	85	1.3	125	50.0	16	50	2.449	2.205	0.980	3
NOSV108M002#0300	V	1000	2.5	85	1.3	125	50.0	16	300	1.000	0.900	0.400	3
4 Volt @ 85°C													
NOSA156M004#1500	A	15	4	85	2	125	1.2	6	1500	0.245	0.220	0.098	1
NOSA156M004#2000	A	15	4	85	2	125	1.2	6	2000	0.212	0.191	0.085	1
NOSB226M004#0600	B	22	4	85	2	125	1.8	6	600	0.412	0.371	0.165	1
NOSB226M004#1900	B	22	4	85	2	125	1.8	6	1900	0.232	0.209	0.093	1
NOSB336M004#0600	B	33	4	85	2	125	2.6	6	600	0.412	0.371	0.165	1
NOSB336M004#1700	B	33	4	85	2	125	2.6	6	1700	0.245	0.220	0.098	1
NOSB476M004#0500	B	47	4	85	2	125	3.8	6	500	0.452	0.406	0.181	1
NOSB476M004#1600	B	47	4	85	2	125	3.8	6	1600	0.252	0.227	0.101	1
NOSC476M004#0300	C	47	4	85	2	125	3.8	6	300	0.663	0.597	0.265	1
NOSC476M004#0500	C	47	4	85	2	125	3.8	6	500	0.514	0.462	0.206	1
NOSW476M004#0150	W	47	4	85	2	125	3.8	6	150	0.849	0.764	0.339	1
NOSW476M004#0500	W	47	4	85	2	125	3.8	6	500	0.465	0.418	0.186	1
NOSC686M004#0200	C	68	4	85	2	125	5.4	6	200	0.812	0.731	0.325	1
NOSC686M004#0500	C	68	4	85	2	125	5.4	6	500	0.514	0.462	0.206	1
NOSC107M004#0070	C	100	4	85	2	125	8.0	6	70	1.373	1.236	0.549	1
NOSC107M004#0150	C	100	4	85	2	125	8.0	6	150	0.938	0.844	0.375	1
NOSC107M004#0400	C	100	4	85	2	125	8.0	6	400	0.574	0.517	0.230	1
NOSX107M004#0100	X	100	4	85	2	125	8.0	6	100	1.095	0.986	0.438	3

OxiCap® NOS Low ESR Series

Niobium Oxide Capacitor



RATINGS & PART NUMBER REFERENCE

AVX Part No.	Case Size	Capacitance (µF)	Rated Voltage (V)	Rated Temperature (°C)	Category Voltage (V)	Category Temperature (°C)	DCL Max. (µA)	DF Max. (%)	ESR Max. @ 100kHz (mΩ)	100kHz RMS Current (A)			MSL
										25°C	85°C	125°C	
NOSX107M004#0400	X	100	4	85	2	125	8.0	6	400	0.548	0.493	0.219	3
NOSC157M004#0090	C	150	4	85	2	125	12.0	6	90	1.211	1.090	0.484	1
NOSC157M004#0150	C	150	4	85	2	125	12.0	6	150	0.938	0.844	0.375	1
NOSC157M004#0400	C	150	4	85	2	125	12.0	6	400	0.574	0.517	0.230	1
NOSY157M004#0100	Y	150	4	85	2	125	12.0	6	100	1.225	1.102	0.490	3
NOSY157M004#0400	Y	150	4	85	2	125	12.0	6	400	0.612	0.551	0.245	3
NOSD227M004#0040	D	220	4	85	2	125	17.6	8	40	2.121	1.909	0.849	3
NOSD227M004#0060	D	220	4	85	2	125	17.6	8	60	1.732	1.559	0.693	3
NOSD227M004#0100	D	220	4	85	2	125	17.6	8	100	1.342	1.207	0.537	3
NOSD227M004#0400	D	220	4	85	2	125	17.6	8	400	0.671	0.604	0.268	3
NOSY227M004#0100	Y	220	4	85	2	125	17.6	10	100	1.225	1.102	0.490	3
NOSY227M004#0400	Y	220	4	85	2	125	17.6	10	400	0.612	0.551	0.245	3
NOSD337M004#0035	D	330	4	85	2	125	26.4	8	35	2.268	2.041	0.907	3
NOSD337M004#0055	D	330	4	85	2	125	26.4	8	55	1.809	1.628	0.724	3
NOSD337M004#0100	D	330	4	85	2	125	26.4	8	100	1.342	1.207	0.537	3
NOSD337M004#0300	D	330	4	85	2	125	26.4	8	300	0.775	0.697	0.310	3
NOSE337M004#0100	E	330	4	85	2	125	26.4	8	100	1.407	1.266	0.563	3
NOSY337M004#0150	Y	330	4	85	2	125	26.4	12	150	1.000	0.900	0.400	3
NOSY337M004#0300	Y	330	4	85	2	125	26.4	12	300	0.707	0.636	0.283	3
NOSD477M004#0100	D	470	4	85	2	125	37.6	12	100	1.342	1.207	0.537	3
NOSD477M004#0300	D	470	4	85	2	125	37.6	12	300	0.775	0.697	0.310	3
NOSE477M004#0075	E	470	4	85	2	125	37.6	12	75	1.625	1.462	0.650	3
NOSE477M004#0100	E	470	4	85	2	125	37.6	12	100	1.407	1.266	0.563	3
NOSE477M004#0300	E	470	4	85	2	125	37.6	12	300	0.812	0.731	0.325	3
NOSV687M004#0075	V	680	4	85	2	125	54.4	14	75	2.000	1.800	0.800	3
NOSV687M004#0300	V	680	4	85	2	125	54.4	14	300	1.000	0.900	0.400	3
6.3 Volt @ 85°C													
NOSA106M006#0800	A	10	6.3	85	3	125	1.2	6	800	0.335	0.302	0.134	1
NOSA106M006#1000	A	10	6.3	85	3	125	1.2	6	1000	0.300	0.270	0.120	1
NOSA106M006#2000	A	10	6.3	85	3	125	1.2	6	2000	0.212	0.191	0.085	1
NOSA106M006#2200	A	10	6.3	85	3	125	1.2	6	2200	0.202	0.182	0.081	1
NOSB156M006#0600	B	15	6.3	85	3	125	1.8	6	600	0.412	0.371	0.165	1
NOSB156M006#2000	B	15	6.3	85	3	125	1.8	6	2000	0.226	0.203	0.090	1
NOSB226M006#0600	B	22	6.3	85	3	125	2.6	6	600	0.412	0.371	0.165	1
NOSB226M006#1900	B	22	6.3	85	3	125	2.6	6	1900	0.232	0.209	0.093	1
NOSB336M006#0600	B	33	6.3	85	3	125	4.0	6	600	0.412	0.371	0.165	1
NOSB336M006#1700	B	33	6.3	85	3	125	4.0	6	1700	0.245	0.220	0.098	1
NOSC336M006#0500	C	33	6.3	85	3	125	4.0	6	500	0.514	0.462	0.206	1
NOSW336M006#0250	W	33	6.3	85	3	125	4.0	6	250	0.657	0.592	0.263	1
NOSW336M006#0500	W	33	6.3	85	3	125	4.0	6	500	0.465	0.418	0.186	1
NOSB476M006#0500	B	47	6.3	85	3	125	5.6	6	500	0.452	0.406	0.181	1
NOSB476M006#0800	B	47	6.3	85	3	125	5.6	6	800	0.357	0.321	0.143	1
NOSC476M006#0300	C	47	6.3	85	3	125	5.7	6	300	0.663	0.597	0.265	1
NOSC476M006#0500	C	47	6.3	85	3	125	5.7	6	500	0.514	0.462	0.206	1
NOSC686M006#0075	C	68	6.3	85	3	125	8.2	6	75	1.327	1.194	0.531	1
NOSC686M006#0200	C	68	6.3	85	3	125	8.2	6	200	0.812	0.731	0.325	1
NOSC686M006#0500	C	68	6.3	85	3	125	8.2	6	500	0.514	0.462	0.206	1
NOSX686M006#0100	X	68	6.3	85	3	125	8.2	6	100	1.095	0.986	0.438	3
NOSX686M006#0500	X	68	6.3	85	3	125	8.2	6	500	0.490	0.441	0.196	3
NOSY686M006#0100	Y	68	6.3	85	3	125	8.2	6	100	1.225	1.102	0.490	3
NOSY686M006#0500	Y	68	6.3	85	3	125	8.2	6	500	0.548	0.493	0.219	3
NOSC107M006#0150	C	100	6.3	85	3	125	12.0	8	150	0.938	0.844	0.375	1
NOSC107M006#0400	C	100	6.3	85	3	125	12.0	8	400	0.574	0.517	0.230	1
NOSD107M006#0080	D	100	6.3	85	3	125	12.0	6	80	1.500	1.350	0.600	3
NOSD107M006#0100	D	100	6.3	85	3	125	12.0	6	100	1.342	1.207	0.537	3
NOSD107M006#0400	D	100	6.3	85	3	125	12.0	6	400	0.671	0.604	0.268	3
NOSY107M006#0100	Y	100	6.3	85	3	125	12.0	6	100	1.225	1.102	0.490	3
NOSY107M006#0400	Y	100	6.3	85	3	125	12.0	6	400	0.612	0.551	0.245	3
NOSD157M006#0050	D	150	6.3	85	3	125	18.0	6	50	1.897	1.708	0.759	3
NOSD157M006#0070	D	150	6.3	85	3	125	18.0	6	70	1.604	1.443	0.641	3
NOSD157M006#0100	D	150	6.3	85	3	125	18.0	6	100	1.342	1.207	0.537	3
NOSD157M006#0400	D	150	6.3	85	3	125	18.0	6	400	0.671	0.604	0.268	3
NOSY157M006#0100	Y	150	6.3	85	3	125	18.0	6	100	1.225	1.102	0.490	3
NOSY157M006#0400	Y	150	6.3	85	3	125	18.0	6	400	0.612	0.551	0.245	3
NOSD227M006#0045	D	220	6.3	85	3	125	26.4	8	45	2.000	1.800	0.800	3
NOSD227M006#0060	D	220	6.3	85	3	125	26.4	8	60	1.732	1.559	0.693	3
NOSD227M006#0100	D	220	6.3	85	3	125	26.4	8	100	1.342	1.207	0.537	3
NOSD227M006#0400	D	220	6.3	85	3	125	26.4	8	400	0.671	0.604	0.268	3
NOSE227M006#0080	E	220	6.3	85	3	125	26.4	12	80	1.573	1.416	0.629	3
NOSE227M006#0100	E	220	6.3	85	3	125	26.4	12	100	1.407	1.266	0.563	3
NOSE227M006#0400	E	220	6.3	85	3	125	26.4	12	400	0.704	0.633	0.281	3



The Important Information/Disclaimer is incorporated in the catalog where these specifications came from or available online at www.avx.com/disclaimer/ by reference and should be reviewed in full before placing any order.

OxiCap® NOS Low ESR Series

Niobium Oxide Capacitor



RATINGS & PART NUMBER REFERENCE

AVX Part No.	Case Size	Capacitance (µF)	Rated Voltage (V)	Rated Temperature (°C)	Category Voltage (V)	Category Temperature (°C)	DCL Max. (µA)	DF Max. (%)	ESR Max. @ 100kHz (mΩ)	100kHz RMS Current (A)			MSL
										25°C	85°C	125°C	
NOSE337M006#0080	E	330	6.3	85	3	125	39.6	12	80	1.573	1.416	0.629	3
NOSE337M006#0100	E	330	6.3	85	3	125	39.6	12	100	1.407	1.266	0.563	3
NOSE337M006#0300	E	330	6.3	85	3	125	39.6	12	300	0.812	0.731	0.325	3
NOSV477M006#0075	V	470	6.3	85	3	125	56.4	14	75	2.000	1.800	0.800	3
NOSV477M006#0300	V	470	6.3	85	3	125	56.4	14	300	1.000	0.900	0.400	3
8 Volt @ 85°C													
NOSA106M008#2200	A	10	8	85	4	125	1.6	10	2200	0.202	0.182	0.081	1
NOSB106M008#1000	B	10	8	85	4	125	1.6	10	1000	0.319	0.287	0.128	1
NOSB156M008#1000	B	15	8	85	4	125	2.4	10	1000	0.319	0.287	0.128	1
NOSB226M008#0700	B	22	8	85	4	125	3.5	10	700	0.382	0.344	0.153	1
NOSB226M008#1800	B	22	8	85	4	125	3.5	10	1800	0.238	0.214	0.095	1
NOSC226M008#0500	C	22	8	85	4	125	3.5	10	500	0.514	0.462	0.206	1
NOSC336M008#0500	C	33	8	85	4	125	5.3	10	500	0.514	0.462	0.206	1
NOSC476M008#0400	C	47	8	85	4	125	7.5	10	400	0.574	0.517	0.230	1
NOSC686M008#0500	C	68	8	85	4	125	11.0	16	500	0.514	0.462	0.206	1
NOSD107M008#0400	D	100	8	85	4	125	16.0	16	400	0.671	0.604	0.268	3

Moisture Sensitivity Level (MSL) is defined according to J-STD-020.

All technical data relates to an ambient temperature of +25°C. Capacitance and DF are measured at 120Hz, 0.5V RMS with a maximum DC bias of 2.2 volts.

DCL is measured at rated voltage after 5 minutes.

The EIA & CECC standards for capacitors allow an ESR movement to 1.25 times catalog limit post mounting.

NOTE: AVX reserves the right to supply higher voltage ratings or tighter tolerance part in the same case size, to the same reliability standards.

QUALIFICATION TABLE

TEST	NOS series (Temperature range -55°C to +125°C)									
	Condition			Characteristics						
Endurance	Apply rated voltage (Ur) at 85°C and / or category voltage (Uc) at 125°C for 2000 hours through a circuit impedance of $\leq 0.1\Omega/V$. Stabilize at room temperature for 1-2 hours before measuring.			Visual examination	no visible damage					
				DCL	initial limit					
				$\Delta C/C$	within $\pm 10\%$ of initial value					
				DF	initial limit					
				ESR	1.25 x initial limit					
Storage Life	Store at 125°C, no voltage applied, for 2000 hours. Stabilize at room temperature for 1-2 hours before measuring.			Visual examination	no visible damage					
				DCL	initial limit					
				$\Delta C/C$	within $\pm 10\%$ of initial value					
				DF	initial limit					
				ESR	1.25 x initial limit					
Biased Humidity	Apply rated voltage (Ur) at 85°C, 85% relative humidity for 1000 hours. Stabilize at room temperature and humidity for 1-2 hours before measuring.			Visual examination	no visible damage					
				DCL	2 x initial limit					
				$\Delta C/C$	within $\pm 10\%$ of initial value					
				DF	1.2 x initial limit					
				ESR	1.25 x initial limit					
Temperature Stability	Step	Temperature°C	Duration(min)		+20°C	-55°C	+20°C	+85°C	+125°C	+20°C
	1	+20	15							
	2	-55	15	DCL	IL*	n/a	IL*	12 x IL*	15 x IL*	IL*
	3	+20	15	$\Delta C/C$	n/a	+0/-10%	$\pm 5\%$	+10/-0%	+12/-0%	$\pm 5\%$
	4	+85	15	DF	IL*	1.5 x IL*	IL*	1.5 x IL*	2 x IL*	IL*
	5	+125	15	ESR	125xIL*	25xIL*	125xIL*	125xIL*	125xIL*	125xIL*
Surge Voltage	Apply 1.3x category voltage (Uc) at 125°C for 1000 cycles of duration 6 min (30 sec charge, 5 min 30 sec discharge) through a charge / discharge resistance of 1000 Ω			Visual examination	no visible damage					
				DCL	initial limit					
				$\Delta C/C$	within $\pm 5\%$ of initial value					
				DF	initial limit					
				ESR	1.25 x initial limit					
Mechanical Shock	MIL-STD-202, Method 213, Condition F			Visual examination	no visible damage					
				DCL	initial limit					
				$\Delta C/C$	within $\pm 5\%$ of initial value					
				DF	initial limit					
				ESR	1.25 x initial limit					
Vibration	MIL-STD-202, Method 204, Condition D			Visual examination	no visible damage					
				DCL	initial limit					
				$\Delta C/C$	within $\pm 5\%$ of initial value					
				DF	initial limit					
				ESR	1.25 x initial limit					

*Initial Limit

OxiCap® NOS Low ESR Series

Niobium Oxide Capacitor



AVX SOLID ELECTROLYTIC CAPACITOR ROADMAP

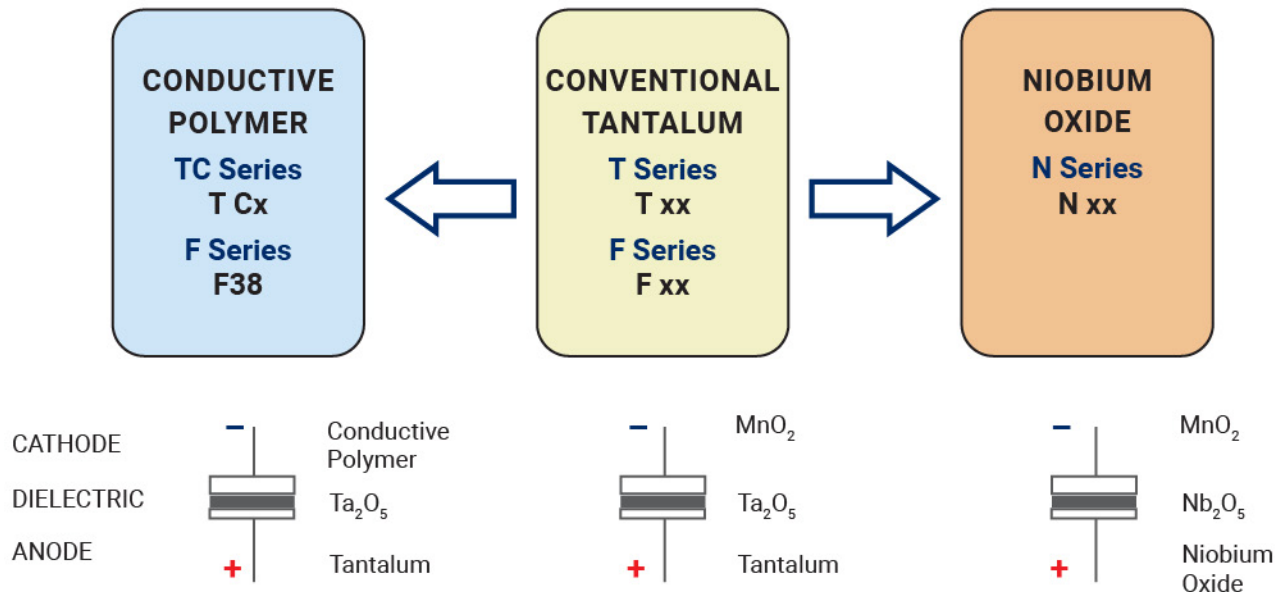

FIVE CAPACITOR CONSTRUCTION STYLES

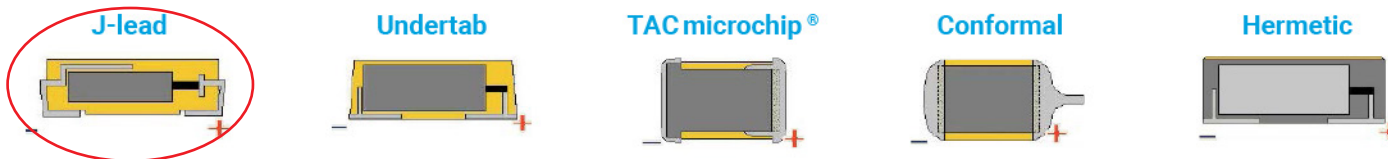

SERIES LINE UP : NIOBIUM OXIDE OxiCap® CAPACITORS

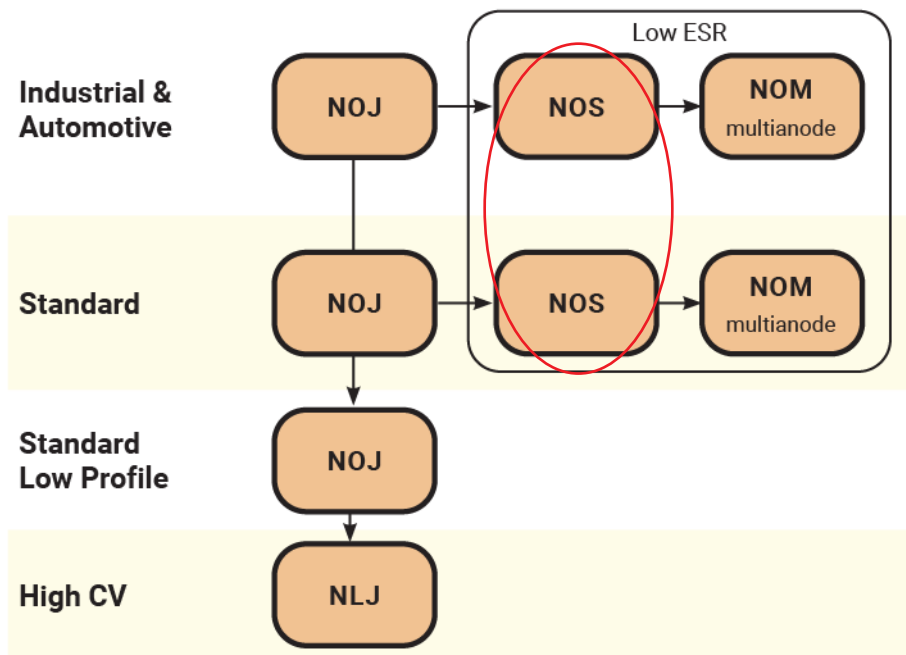

OxiCap® NOM Low ESR Multianodes

Niobium Oxide Capacitor



FEATURES

- Multi-anode Construction
- Super Low ESR
- 100% Surge Current Tested
- Non-Burn Safe Technology
- CV Range: 220-680µF / 1.8-6.3V
- IBM Global Approval Received in 2004
- Elektra Award Received in 2005

APPLICATIONS

- High Power Low Voltage Industrial Power Supplies



LEAD-FREE

LEAD-FREE COMPATIBLE COMPONENT



RoHS COMPLIANT



NON-BURN
NON-SMOKE



Elektra Award
2005

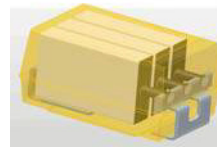
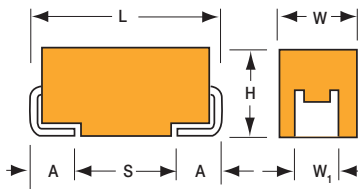

NOM MULTIANODE CONSTRUCTION

MARKING

E CASE

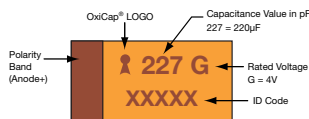

CASE DIMENSIONS:

millimeters (inches)

Code	EIA Code	EIA Metric	L±0.20 (0.008)	W+0.20 (0.008) -0.10 (0.004)	H+0.20 (0.008) -0.10 (0.004)	W ₁ ±0.20 (0.008)	A+0.30 (0.012) -0.20 (0.008)	S Min.
E	2917	7343-43	7.30 (0.287)	4.30 (0.169)	4.10 (0.162)	2.40 (0.094)	1.30 (0.051)	4.40 (0.173)

W₁ dimension applies to the termination width for A dimensional area only.

HOW TO ORDER

NOM

Type

E

Case Size
See table above

227

Capacitance Code
1st two digits represent significant figures, 3rd digit represents multiplier in pF

M

Tolerance
M = ±20%

006

Rated DC Voltage
001 = 1.8Vdc
002 = 2.5Vdc
004 = 4Vdc
006 = 6.3Vdc

R

Packaging
R = Pure Tin 7" Reel
S = Pure Tin 13" Reel

0040

ESR in mΩ

TECHNICAL SPECIFICATIONS

Technical Data:	All technical data relate to an ambient temperature of +25°C is not stated					
Capacitance Range:	220 µF to 680 µF					
Capacitance Tolerance:	±20%					
Leakage Current DCL:	0.02CV					
Rated Voltage DC (V _R)	≤ +85°C:	1.8	2.5	4	6.3	
Category Voltage (V _C)	≤ +125°C:	0.9	1.3	2	3	
Surge Voltage (V _S)	≤ +85°C:	2.3	3.3	5.2	8	
Surge Voltage (V _S)	≤ +125°C:	1.2	1.7	2.6	4	
Temperature Range:	-55°C to +125°C					
Reliability:	0.2% per 1000 hours at 85°C, V _R 0.1Ω/V series impedance, 60% confidence level Meets requirements of AEC-Q200					

OxiCap® NOM Low ESR Multianodes

Niobium Oxide Capacitor



CAPACITANCE AND RATED VOLTAGE RANGE (LETTER DENOTES CASE SIZE)

Capacitance		Rated Voltage DC (V _R) to 85°C			
µF	Code	1.8V (x)	2.5V (e)	4.0V (G)	6.3V (J)
220	227				E(40)
330	337			E(35)	E(23,35)
470	477		E(30)	E(23,30)	
680	687	E(23)	E(23)		

Released ratings, (ESR ratings in mOhms in parentheses)

Note: Voltage ratings are minimum values. AVX reserves the right to supply higher voltage ratings in the same case size, to the same reliability standards.

RATINGS & PART NUMBER REFERENCE

AVX Part No.	Case Size	Capacitance (µF)	Rated Voltage (V)	Rated Temperature (°C)	Category Voltage (V)	Category Temperature (°C)	DCL Max. (µA)	DF Max. (%)	ESR Max. @ 100kHz (mΩ)	100kHz RMS Current (A)			MSL
										25°C	85°C	125°C	
1.8 Volt @ 85°C													
NOME687M001#0023	E	680	1.8	85	0.9	125	24.5	6	23	3.753	3.378	1.501	3
2.5 Volt @ 85°C													
NOME477M002#0030	E	470	2.5	85	1.3	125	23.5	10	30	3.286	2.958	1.315	3
NOME687M002#0023	E	680	2.5	85	1.3	125	34	6	23	3.753	3.378	1.501	3
4 Volt @ 85°C													
NOME337M004#0035	E	330	4	85	2	125	26.4	8	35	3.043	2.738	1.217	3
NOME477M004#0023	E	470	4	85	2	125	37.6	6	23	3.753	3.378	1.501	3
NOME477M004#0030	E	470	4	85	2	125	37.6	6	30	3.286	2.958	1.315	3
6.3 Volt @ 85°C													
NOME227M006#0040	E	220	6.3	85	3	125	26.4	12	40	2.846	2.561	1.138	3
NOME337M006#0023	E	330	6.3	85	3	125	39.6	6	23	3.753	3.378	1.501	3
NOME337M006#0035	E	330	6.3	85	3	125	39.6	6	35	3.043	2.738	1.217	3

Moisture Sensitivity Level (MSL) is defined according to J-STD-020.

All technical data relates to an ambient temperature of +25°C. Capacitance and DF are measured at 120Hz, 0.5V RMS with a maximum DC bias of 2.2 volts.

DCL is measured at rated voltage after 5 minutes.

ESR allowed to move up to 125 times catalog limit post mounting.

For typical weight and composition see page 274.

NOTE: AVX reserves the right to supply higher voltage ratings or tighter tolerance part in the same case size, to the same reliability standards.

OxiCap® NOM Low ESR Multianodes

Niobium Oxide Capacitor

QUALIFICATION TABLE

TEST	NOS series (Temperature range -55°C to +125°C)									
	Condition			Characteristics						
Endurance	Apply rated voltage (Ur) at 85°C and / or category voltage (Uc) at 125°C for 2000 hours through a circuit impedance of $\leq 0.1\Omega/V$. Stabilize at room temperature for 1-2 hours before measuring.			Visual examination	no visible damage					
				DCL	initial limit					
				$\Delta C/C$	within $\pm 10\%$ of initial value					
				DF	initial limit					
				ESR	1.25 x initial limit					
Storage Life	Store at 125°C, no voltage applied, for 2000 hours. Stabilize at room temperature for 1-2 hours before measuring.			Visual examination	no visible damage					
				DCL	initial limit					
				$\Delta C/C$	within $\pm 10\%$ of initial value					
				DF	initial limit					
				ESR	1.25 x initial limit					
Humidity	Store at 65°C and 95% relative humidity for 500 hours, with no applied voltage. Stabilize at room temperature and humidity for 1-2 hours before measuring.			Visual examination	no visible damage					
				DCL	1.5 x initial limit					
				$\Delta C/C$	within $\pm 10\%$ of initial value					
				DF	1.2 x initial limit					
				ESR	1.25 x initial limit					
Biased Humidity	Apply rated voltage (Ur) at 85°C, 85% relative humidity for 1000 hours. Stabilize at room temperature and humidity for 1-2 hours before measuring.			Visual examination	no visible damage					
				DCL	2 x initial limit					
				$\Delta C/C$	within $\pm 10\%$ of initial value					
				DF	1.2 x initial limit					
				ESR	1.25 x initial limit					
Temperature Stability	Step	Temperature°C	Duration(min)		+20°C	-55°C	+20°C	+85°C	+125°C	+20°C
	1	+20	15	DCL	IL*	n/a	IL*	12 x IL*	15 x IL*	IL*
	2	-55	15	$\Delta C/C$	n/a	+0/-10%	$\pm 5\%$	+10/-0%	+12/-0%	$\pm 5\%$
	3	+20	15	DF	IL*	1.5 x IL*	IL*	1.5 x IL*	2 x IL*	IL*
	4	+85	15	ESR	1.25 x IL*	2.5 x IL*	1.25 x IL*	1.25 x IL*	1.25 x IL*	1.25 x IL*
	5	+125	15							
	6	+20	15							
Surge Voltage	Apply 1.3x category voltage (Uc) at 125°C for 1000 cycles of duration 6 min (30 sec charge, 5 min 30 sec discharge) through a charge / discharge resistance of 1000 Ω			Visual examination	no visible damage					
				DCL	initial limit					
				$\Delta C/C$	within $\pm 5\%$ of initial value					
				DF	initial limit					
				ESR	1.25 x initial limit					
Mechanical Shock	MIL-STD-202, Method 213, Condition F			Visual examination	no visible damage					
				DCL	initial limit					
				$\Delta C/C$	within $\pm 5\%$ of initial value					
				DF	initial limit					
				ESR	1.25 x initial limit					
Vibration	MIL-STD-202, Method 204, Condition D			Visual examination	no visible damage					
				DCL	initial limit					
				$\Delta C/C$	within $\pm 5\%$ of initial value					
				DF	initial limit					
				ESR	1.25 x initial limit					

*Initial Limit

OxiCap® NOM Low ESR Multianodes

Niobium Oxide Capacitor

AVX SOLID ELECTROLYTIC CAPACITOR ROADMAP

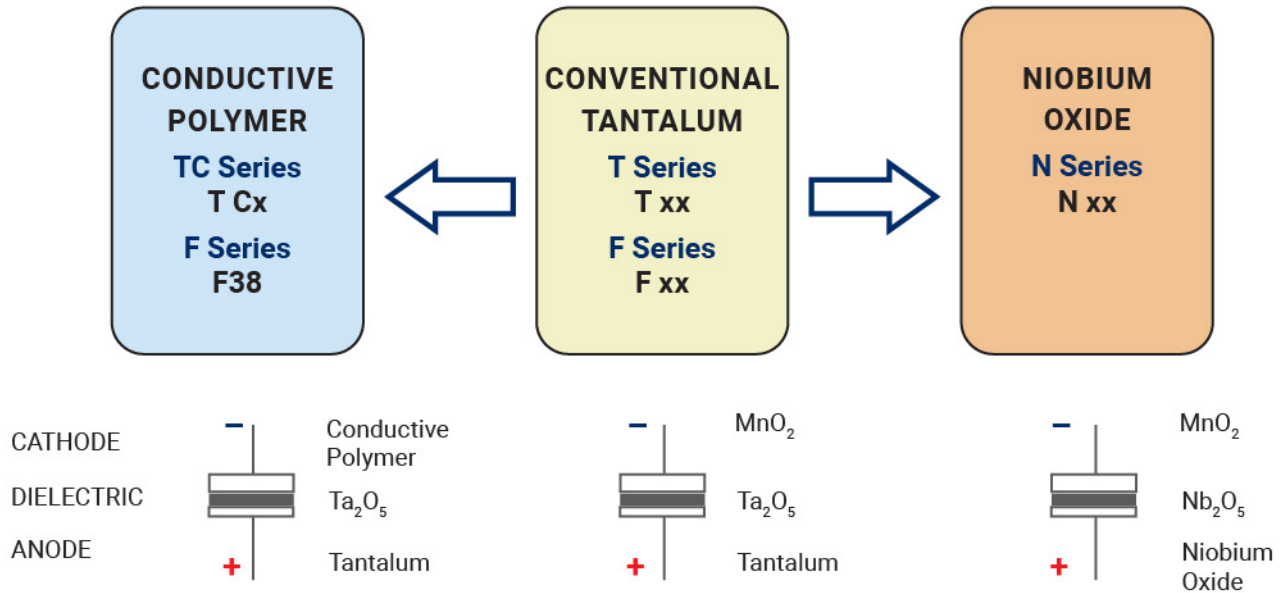

FIVE CAPACITOR CONSTRUCTION STYLES

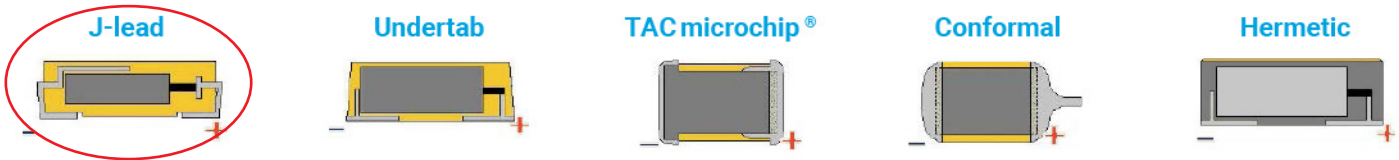

SERIES LINE UP : NIOBIUM OXIDE OxiCap® CAPACITORS

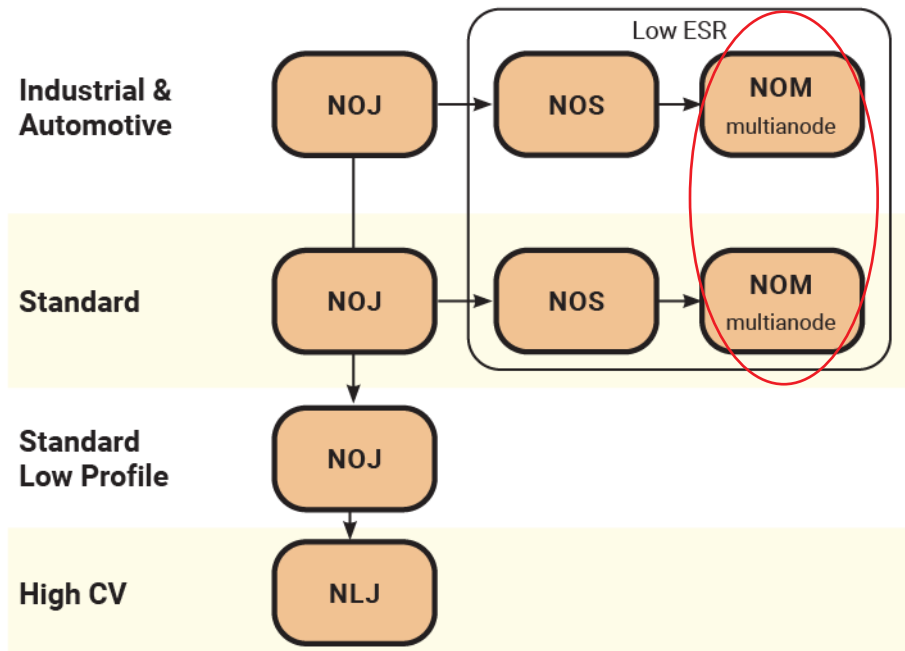

TCJ Series

Conductive Polymer Solid Electrolytic Chip Capacitors

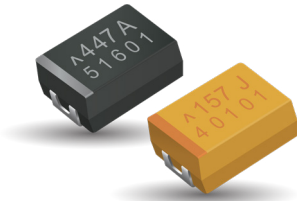

FEATURES

- Conductive Polymer Electrode
- Benign Failure Mode Under Recommended Use Conditions
- Lower ESR
- 3x Reflow 260°C Compatible
- 100% Surge Current Tested
- CV Range: 0.47-470µF / 2.5-125V
- 18 Case Sizes Available



Elektra Award 2010



LEAD-FREE

LEAD-FREE COMPATIBLE COMPONENT



RoHS COMPLIANT

APPLICATIONS

- Smart Phone, Tablets, Notebook, LCD TV, Power Supplies

CASE DIMENSIONS:

millimeters (inches)

Code	EIA Code	EIA Metric	L±0.20 (0.008)	W+0.20 (0.008) -0.10 (0.004)	H+0.20 (0.008) -0.10 (0.004)	W ₁ ±0.20 (0.008)	A+0.30 (0.012) -0.20 (0.008)	S Min.
A	1206	3216-18	3.20 (0.126)	1.60 (0.063)	1.60 (0.063)	1.20 (0.047)	0.80 (0.031)	1.10 (0.043)
B	1210	3528-21	3.50 (0.138)	2.80 (0.110)	1.90 (0.075)	2.20 (0.087)	0.80 (0.031)	1.40 (0.055)
C	2312	6032-28	6.00 (0.236)	3.20 (0.126)	2.60 (0.102)	2.20 (0.087)	1.30 (0.051)	2.90 (0.114)
D	2917	7343-31	7.30 (0.287)	4.30 (0.169)	2.90 (0.114)	2.40 (0.094)	1.30 (0.051)	4.40 (0.173)
E	2917	7343-43	7.30 (0.287)	4.30 (0.169)	4.10 (0.162)	2.40 (0.094)	1.30 (0.051)	4.40 (0.173)
G	1206	3216-15	3.20 (0.126)	1.60 (0.063)	1.50 (0.059) max	1.20 (0.047)	0.80 (0.031)	1.10 (0.043)
H	1210	3528-15	3.50 (0.138)	2.80 (0.110)	1.50 (0.059) max	2.20 (0.087)	0.80 (0.031)	1.40 (0.055)
K	1206	3216-10	3.20 (0.126)	1.60 (0.063)	1.00 (0.039) max	1.20 (0.047)	0.80 (0.031)	1.10 (0.043)
N	0805	2012-10	2.05 (0.081)	1.30 (0.051)	1.00 (0.039) max	1.00 (0.039)	0.50 (0.020)	0.85 (0.033)
P	0805	2012-15	2.05 (0.081)	1.35 (0.053)	1.50 (0.059) max	1.00±0.10 (0.039±0.004)	0.50 (0.020)	0.85 (0.033)
R	0805	2012-12	2.05 (0.081)	1.30 (0.051)	1.20 (0.047) max	1.00±0.10 (0.039±0.004)	0.50 (0.020)	0.85 (0.033)
S	1206	3216-12	3.20 (0.126)	1.60 (0.063)	1.20 (0.047) max	1.20 (0.047)	0.80 (0.031)	1.10 (0.043)
T	1210	3528-12	3.50 (0.138)	2.80 (0.110)	1.20 (0.047) max	2.20 (0.087)	0.80 (0.031)	1.40 (0.055)
U	2924	7361-43	7.30 (0.287)	6.10 (0.240)	4.10 (0.162)	3.10 (0.122)	1.30 (0.051)	4.40 (0.173)
W	2312	6032-15	6.00 (0.236)	3.20 (0.126)	1.50 (0.059) max	2.20 (0.087)	1.30 (0.051)	2.90 (0.114)
X	2917	7343-15	7.30 (0.287)	4.30 (0.169)	1.50 (0.059) max	2.40 (0.094)	1.30 (0.051)	4.40 (0.173)
Y	2917	7343-20	7.30 (0.287)	4.30 (0.169)	2.00 (0.079) max	2.40 (0.094)	1.30 (0.051)	4.40 (0.173)
5	2917	7343-40	7.30 (0.287)	4.30 (0.169)	3.80 (0.150)	2.40 (0.094)	1.30 (0.051)	4.40 (0.173)

W₁ dimension applies to the termination width for A dimensional area only.

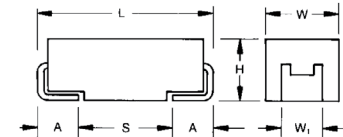

MARKING

A, B, C, D, E, G, H, K, S, T, U, W, X, Y, 5 CASE

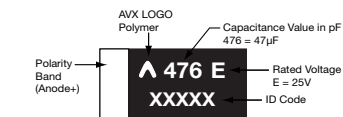
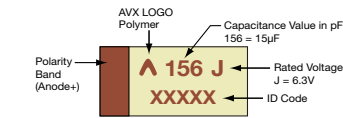

N, P, R CASE

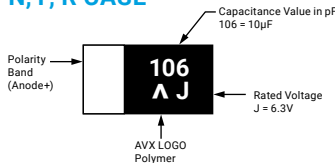

HOW TO ORDER

TCJ	A	226	M	004	R	0300	E
Type	Case Size See table above	Capacitance Code pF code: 1st two digits represent significant figures, 3rd digit represents multiplier (number of zeros to follow)	Tolerance M = ±20%	Rated DC Voltage 002 = 2.5Vdc 035 = 35Vdc 004 = 4Vdc 050 = 50Vdc 006 = 6.3Vdc 063 = 63Vdc 010 = 10Vdc 075 = 75Vdc 016 = 16Vdc 100 = 100Vdc 020 = 20Vdc 125 = 125Vdc 025 = 25Vdc	Packaging R = Pure Tin 7" Reel S = Pure Tin 13" Reel	ESR in mΩ	Additional Character E = Black resin

Part Numbers already changed to an "E" suffix will continue to be supplied with only black resin. Those Part Numbers currently produced with gold resin will eventually change to black before July, 2020.

TECHNICAL SPECIFICATIONS (COMMON FOR ALL TCJ SERIES)

Technical Data: All technical data relate to an ambient temperature of +25°C
Capacitance Tolerance: ±20%
Leakage Current DCL: 0.1CV
Resistance to soldering heat: 3x260°C peak for max. 10s reflow

NOTE: Conductive Polymer Capacitors are designed to operate within the limits of the environmental conditions specified for each series. If operated continuously at their maximum temperature and / or humidity limit, or beyond these limits, capacitors may exhibit a parametric shift in capacitance and increases in ESR. These changes may occur earlier if the specified environmental conditions are exceeded. Similarly, their normal operational time period will be significantly extended if their general duty cycle includes operation below maximum temperature within humidity controlled environments. Careful attention should be paid to maximum temperature with associated high humidity environments as well as voltage derating, ripple current and current surges. Please reference the AVX Conductive Polymer Capacitor Guidelines for more information or contact factory for application assistance.

TCJ Series

Conductive Polymer Solid Electrolytic Chip Capacitors



CAPACITANCE AND RATED VOLTAGE RANGE (LETTER DENOTES CASE SIZE)

Cap		Rated Voltage DC (V _R) to 85°C												
μF	Code	2.5V (e)	4V (G)	6.3V (J)	10V (A)	16V (C)	20V (D)	25V (E)	35V (V)	50V (T)	63V (J)	75V (P)	100V (A)	125V (B)
0.47	474										B(400)			
0.68	684									B(400)	B(300)			
1.0	105							P(500)		B(300)	B(300) C(300)			
1.5	155								B(200)	B(300) C(300)	C(300)			
2.2	225								B(200)	C(300)	C(200)			
3.3	335								B(200)	C(200)	C(200)			D(250)
4.7	475				K(300,500) R(500)			B(100,150)	B(200) C(200)	C(200) X(250) Y(250)	C(200) D(120)	D(150)	D(250)	
6.8	685					A(200)		A(150) B(90,150) T(100,150)	C(200)	C(200) D(120)	D(120) E(100,150)	D(120)		
10	106			A(300) N(200,250,500) R(500)	A(200,300)	A(200) B(100,200) T(100,150,200)	A(150) B(150)	A(150) B(90,100,150)	B(200) C(200) Y(70)	D(90,120) E(70,100)	E(100,150)			
15	156		A(300)	A(300)	A(200)	B(90,150)	B(150)	B(100,150) Y(90)	B(200) C(200) D(70,100) Y(70,100)	D(150) E(70,100)	E(150)			
22	226		A(300)	A(300), B(70), K(400) N(500), R(500) S(400), T(150)	B(70,300) T(70,150)	A(300) B(70,150)	B(90,150) X(100) Y(70)	B(100,150) C(100) D(60,100) X(100), Y(70)	D(70,100) Y(150)	D(90), E(75), E(150)				
33	336		A(300)	A(200) B(70,200) T(150)	B(70,200) C(100) T(70,150)	A(200) H(150) Y(45,60,70)	X(100) Y(70)	D(60,100) X(70,100) Y(60,70,100)	D(70,100) E(55,70) U(70) Y(100)					
47	476		A(200) T(80)	A(70,100,200) B(55,70) K(150,200,400) P(500), R(500) T(55,70,80,120)	B(70) C(100) H(100)	D(45,70), H(150) X(45,70) Y(45,70)	D(55), X(55,70) Y(70)	D(60,100) E(50) Y(100)	E(55) U(70) Y(100)					
68	686	A(250)	A(250) B(70) T(80)	B(55,70) C(55,100), H(100) T(200), W(70)	D(45,55) Y(45,55)	D(50) Y(50)	D(55) E(45) Y(50)	D(70) E(50) Y(100)						
100	107	A(200) B(70)	A(200) B(40,70) G(300) T(70,150)	A(100,150) B(40,45,55,70) C(70,100) T(70,200), W(70)	D(18,25,45,55,80) Y(18,25,45,55)	D(50) E(40) Y(50)	C(70) D(55) E(45) Y(55)	D(55,70) E(80) U(70)						
150	157	B(70)	B(70) D(15) Y(15,25,45)	B(25,35,45,55,70) D(12,15,25,40) H(200), W(40,70) Y(15,25,40)	D(25,40,45,55) Y(25,40,45,55)	C(70) D(40,50,70) E(40) Y(40,50,70)		U(70)						
220	227	B(35,45,70)	B(35,45,60,70) D(12,15,25,40) Y(15,25,40)	B(70,200) D(12,15,25,35,40,50) H(170) Y(15,18,25,35,40,50)	D(12,15,25,40,50) Y(15,25,40,50)	D(35,50) E(50)	U(70)							
330	337	B(35,45,70,Y) (25,40)	D(15,25,40,50) Y(15,25,40,50)	D(12,15,18,25,40,50) Y(15,25,40,50)	D(25) 5(35,100)	E(35, 50,70) 5(100)								
470	477	D(12,15,25,40,50) Y(15,25,40,50)	D(10,12,15,25,40,50) Y(15,25,40,50)	D(25) X(35,50,100)		5(100)								

Released ratings, (ESR ratings in mOhms in parentheses)

Engineering samples - please contact AVX

Note: Voltage ratings are minimum values. AVX reserves the right to supply higher voltage ratings in the same case size, to the same reliability standards.

TCJ Series

Conductive Polymer Solid Electrolytic Chip Capacitors



RATINGS & PART NUMBER REFERENCE

AVX Part No.	Case Size	Capacitance (µF)	Rated Voltage (V)	Maximum Operating Temperature (°C)	DCL Max. (µA)	DF Max. (%)	ESR Max. @ 100kHz (mΩ)	100kHz RMS Current (mA)				Product Category	MSL
								45°C	85°C	105°C	125°C		
2.5 Volt @ 85°C													
TCJA686M002#0250E	A	68	2.5	105	17	6	250	600	400	300	-	3	3
TCJA107M002#0200E	A	100	2.5	105	25	6	200	700	500	300	-	3	3
TCJB107M002#0070E	B	100	2.5	125	25	6	70	1300	900	600	300	1	3
TCJB157M002#0070E	B	150	2.5	105	37.5	6	70	1300	900	600	-	3	3
TCJB227M002#0035E	B	220	2.5	105	55	8	35	1900	1300	900	-	3	3
TCJB227M002#0045E	B	220	2.5	105	55	8	45	1700	1200	800	-	3	3
TCJB227M002#0070E	B	220	2.5	105	55	8	70	1300	900	600	-	3	3
TCJB337M002#0035E	B	330	2.5	105	82.5	8	35	1900	1300	900	-	3	3
TCJB337M002#0045E	B	330	2.5	105	82.5	8	45	1700	1200	800	-	3	3
TCJB337M002#0070E	B	330	2.5	105	82.5	8	70	1300	900	600	-	3	3
TCJY337M002#0025E	Y	330	2.5	105	82.5	6	25	2700	1900	1200	-	2	3
TCJY337M002#0040E	Y	330	2.5	105	82.5	6	40	2200	1500	1000	-	3	3
TCJD477M002#0012E	D	470	2.5	105	117.5	6	12	4300	3000	1900	-	2	3
TCJD477M002#0015E	D	470	2.5	105	117.5	6	15	3900	2700	1800	-	2	3
TCJD477M002#0025E	D	470	2.5	105	117.5	6	25	3000	2100	1400	-	2	3
TCJD477M002#0040E	D	470	2.5	105	117.5	6	40	2400	1700	1100	-	3	3
TCJD477M002#0050E	D	470	2.5	105	117.5	6	50	2100	1500	900	-	3	3
TCJY477M002#0015E	Y	470	2.5	85	117.5	6	15	3500	2500	-	-	5	3
TCJY477M002#0025E	Y	470	2.5	105	117.5	6	25	2700	1900	1200	-	3	3
TCJY477M002#0040E	Y	470	2.5	105	117.5	6	40	2200	1500	1000	-	3	3
TCJY477M002#0050E	Y	470	2.5	105	117.5	6	50	1900	1300	900	-	3	3
4 Volt @ 85°C													
TCJA156M004#0300E	A	15	4	125	6	6	300	600	400	300	200	1	3
TCJA226M004#0300E	A	22	4	125	8.8	6	300	600	400	300	200	1	3
TCJA336M004#0300E	A	33	4	125	13.2	6	300	600	400	300	200	1	3
TCJA476M004#0200E	A	47	4	105	18.8	6	200	700	500	300	-	3	3
TCJT476M004#0080E	T	47	4	105	18.8	8	80	1100	800	500	-	3	3
TCJA686M004#0250E	A	68	4	105	27.2	6	250	600	400	300	-	3	3
TCJB686M004#0070E	B	68	4	125	27.2	6	70	1300	900	600	300	1	3
TCJT686M004#0080E	T	68	4	105	27.2	8	80	1100	800	500	-	3	3
TCJA107M004#0200E	A	100	4	105	40	6	200	700	500	300	-	3	3
TCJB107M004#0040E	B	100	4	105	40	8	40	1800	1300	800	-	3	3
TCJB107M004#0070E	B	100	4	125	40	8	70	1300	900	600	300	0	3
TCJG107M004#0300E	G	100	4	105	40	10	300	600	400	300	-	3	3
TCJT107M004#0070E	T	100	4	105	40	8	70	1200	800	500	-	3	3
TCJT107M004#0150E	T	100	4	105	40	8	150	800	600	400	-	3	3
TCJB157M004#0070E	B	150	4	105	60	6	70	1300	900	600	-	3	3
TCJD157M004#0015E	D	150	4	105	60	6	15	3900	2700	1800	-	2	3
TCJY157M004#0015E	Y	150	4	105	60	6	15	3500	2500	1600	-	2	3
TCJY157M004#0025E	Y	150	4	105	60	6	25	2700	1900	1200	-	2	3
TCJY157M004#0045E	Y	150	4	105	60	6	45	2000	1400	900	-	3	3
TCJB227M004#0035E	B	220	4	105	88	10	35	1900	1300	900	-	3	3
TCJB227M004#0045E	B	220	4	105	88	10	45	1700	1200	800	-	3	3
TCJB227M004#0060E	B	220	4	105	88	10	60	1400	1000	600	-	3	3
TCJB227M004#0070E	B	220	4	105	88	10	70	1300	900	600	-	3	3
TCJD227M004#0012E	D	220	4	105	88	6	12	4300	3000	1900	-	2	3
TCJD227M004#0015E	D	220	4	105	88	6	15	3900	2700	1800	-	2	3
TCJD227M004#0025E	D	220	4	105	88	6	25	3000	2100	1400	-	2	3
TCJD227M004#0040E	D	220	4	105	88	6	40	2400	1700	1100	-	2	3
TCJY227M004#0015E	Y	220	4	105	88	6	15	3500	2500	1600	-	2	3
TCJY227M004#0025E	Y	220	4	105	88	6	25	2700	1900	1200	-	2	3
TCJY227M004#0040E	Y	220	4	105	88	6	40	2200	1500	1000	-	3	3
TCJD337M004#0015E	D	330	4	105	132	6	15	3900	2700	1800	-	2	3
TCJD337M004#0025E	D	330	4	105	132	6	25	3000	2100	1400	-	2	3
TCJD337M004#0040E	D	330	4	105	132	6	40	2400	1700	1100	-	3	3
TCJD337M004#0050E	D	330	4	105	132	6	50	2100	1500	900	-	3	3
TCJY337M004#0015E	Y	330	4	85	132	6	15	3500	2500	-	-	5	3
TCJY337M004#0025E	Y	330	4	105	132	6	25	2700	1900	1200	-	3	3
TCJY337M004#0040E	Y	330	4	105	132	6	40	2200	1500	1000	-	3	3
TCJY337M004#0050E	Y	330	4	105	132	6	50	1900	1300	900	-	3	3
TCJD477M004#0010E	D	470	4	105	188	6	10	4700	3300	2100	-	2	3
TCJD477M004#0012E	D	470	4	105	188	6	12	4300	3000	1900	-	2	3
TCJD477M004#0015E	D	470	4	105	188	6	15	3900	2700	1800	-	2	3
TCJD477M004#0025E	D	470	4	105	188	6	25	3000	2100	1400	-	2	3
TCJD477M004#0040E	D	470	4	105	188	6	40	2400	1700	1100	-	2	3
TCJD477M004#0050E	D	470	4	105	188	6	50	2100	1500	900	-	2	3
TCJY477M004#0015E	Y	470	4	85	188	6	15	3500	2500	-	-	5	3
TCJY477M004#0025E	Y	470	4	105	188	6	25	2700	1900	1200	-	3	3



The Important Information/Disclaimer is incorporated in the catalog where these specifications came from or available online at www.avx.com/disclaimer/ by reference and should be reviewed in full before placing any order.

TCJ Series

Conductive Polymer Solid Electrolytic Chip Capacitors



RATINGS & PART NUMBER REFERENCE

AVX Part No.	Case Size	Capacitance (µF)	Rated Voltage (V)	Maximum Operating Temperature (°C)	DCL Max. (µA)	DF Max. (%)	ESR Max. @ 100kHz (mΩ)	100kHz RMS Current (mA)				Product Category	MSL
								45°C	85°C	105°C	125°C		
TCJY477M004#0040E	Y	470	4	105	188	6	40	2200	1500	1000	-	3	3
TCJY477M004#0050E	Y	470	4	105	188	6	50	1900	1300	900	-	3	3
6.3 Volt @ 85°C													
TCJA106M006#0300E	A	10	6.3	125	6	6	300	600	400	300	200	1	3
TCJN106M006#0200E	N	10	6.3	105	6	6	200	600	400	300	-	3	3
TCJN106M006#0250E	N	10	6.3	105	6	6	250	600	400	300	-	3	3
TCJN106M006#0500E	N	10	6.3	105	6	6	500	400	300	200	-	3	3
TCJR106M006#0500E	R	10	6.3	105	6	6	500	400	300	200	-	3	3
TCJA156M006#0300E	A	15	6.3	125	9	6	300	600	400	300	200	1	3
TCJA226M006#0300E	A	22	6.3	125	13.2	6	300	600	400	300	200	1	3
TCJB226M006#0070E	B	22	6.3	125	13.2	6	70	1300	900	600	300	0	3
TCJK226M006#0400E	K	22	6.3	105	13.2	8	400	500	400	200	-	3	3
TCJN226M006#0500E	N	22	6.3	105	13.2	10	500	400	300	200	-	3	3
TCJR226M006#0500E	R	22	6.3	105	13.2	10	500	400	300	200	-	3	3
TCJS226M006#0400E	S	22	6.3	105	13.2	8	400	500	400	200	-	3	3
TCJT226M006#0150E	T	22	6.3	105	13.2	6	150	800	600	400	-	3	3
TCJA336M006#0200E	A	33	6.3	105	19.8	6	200	700	500	300	-	3	3
TCJB336M006#0070E	B	33	6.3	125	19.8	6	70	1300	900	600	300	0	3
TCJB336M006#0200E	B	33	6.3	125	19.8	6	200	800	600	400	200	0	3
TCJT336M006#0150E	T	33	6.3	105	19.8	8	150	800	600	400	-	3	3
TCJA476M006#0070E	A	47	6.3	105	28.2	6	70	1200	800	500	-	3	3
TCJA476M006#0100E	A	47	6.3	105	28.2	6	100	1000	700	500	-	3	3
TCJA476M006#0200E	A	47	6.3	105	28.2	6	200	700	500	300	-	3	3
TCJB476M006#0055E	B	47	6.3	105	28.2	6	55	1500	1100	700	-	2	3
TCJB476M006#0070E	B	47	6.3	125	28.2	6	70	1300	900	600	300	1	3
TCJK476M006#0150E	K	47	6.3	105	28.2	6	150	800	600	400	-	3	3
TCJK476M006#0200E	K	47	6.3	105	28.2	6	200	700	500	300	-	3	3
TCJK476M006#0400E	K	47	6.3	105	28.2	6	400	500	400	200	-	3	3
TCJP476M006#0500E	P	47	6.3	105	28.2	10	500	400	300	200	-	3	3
TCJR476M006#0500E	R	47	6.3	105	28.2	10	500	400	300	200	-	3	3
TCJT476M006#0055E	T	47	6.3	105	28.2	8	55	1300	900	600	-	3	3
TCJT476M006#0070E	T	47	6.3	105	28.2	8	70	1200	800	500	-	3	3
TCJT476M006#0080E	T	47	6.3	105	28.2	8	80	1100	800	500	-	3	3
TCJT476M006#0120E	T	47	6.3	105	28.2	8	120	900	600	400	-	3	3
TCJB686M006#0055E	B	68	6.3	125	40.8	8	55	1500	1100	700	400	1	3
TCJB686M006#0070E	B	68	6.3	125	40.8	8	70	1300	900	600	300	1	3
TCJC686M006#0055E	C	68	6.3	125	40.8	6	55	1800	1300	800	500	1	3
TCJC686M006#0100E	C	68	6.3	125	40.8	6	100	1300	900	600	300	1	3
TCJH686M006#0100E	H	68	6.3	105	40.8	6	100	1000	700	500	-	3	3
TCJT686M006#0200E	T	68	6.3	105	40.8	8	200	700	500	300	-	3	3
TCJW686M006#0070E	W	68	6.3	125	40.8	8	70	1400	1000	600	400	1	3
TCJA107M006#0100E	A	100	6.3	105	60	10	100	1000	700	500	-	3	3
TCJA107M006#0150E	A	100	6.3	105	60	10	150	800	600	400	-	3	3
TCJB107M006#0040E	B	100	6.3	105	60	10	40	1800	1300	800	-	3	3
TCJB107M006#0045E	B	100	6.3	105	60	10	45	1700	1200	800	-	3	3
TCJB107M006#0055E	B	100	6.3	105	60	10	55	1500	1100	700	-	3	3
TCJB107M006#0070E	B	100	6.3	105	60	10	70	1300	900	600	-	3	3
TCJC107M006#0070E	C	100	6.3	105	60	6	70	1600	1100	700	-	3	3
TCJC107M006#0100E	C	100	6.3	105	60	6	100	1300	900	600	-	3	3
TCJT107M006#0070E	T	100	6.3	105	60	10	70	1200	800	500	-	3	3
TCJT107M006#0200E	T	100	6.3	105	60	10	200	700	500	300	-	3	3
TCJW107M006#0070E	W	100	6.3	105	60	6	70	1400	1000	600	-	3	3
TCJB157M006#0025E	B	150	6.3	105	90	10	25	2200	1500	1000	-	3	3
TCJB157M006#0035E	B	150	6.3	105	90	10	35	1900	1300	900	-	3	3
TCJB157M006#0045E	B	150	6.3	105	90	10	45	1700	1200	800	-	3	3
TCJB157M006#0055E	B	150	6.3	105	90	10	55	1500	1100	700	-	3	3
TCJB157M006#0070E	B	150	6.3	105	90	10	70	1300	900	600	-	3	3
TCJD157M006#0012E	D	150	6.3	105	90	6	12	4300	3000	1900	-	2	3
TCJD157M006#0015E	D	150	6.3	105	90	6	15	3900	2700	1800	-	2	3
TCJD157M006#0025E	D	150	6.3	105	90	6	25	3000	2100	1400	-	2	3
TCJD157M006#0040E	D	150	6.3	105	90	6	40	2400	1700	1100	-	2	3
TCJH157M006#0200E	H	150	6.3	105	90	6	200	700	500	300	-	3	3
TCJW157M006#0040E	W	150	6.3	105	90	6	40	1800	1300	800	-	3	3
TCJW157M006#0070E	W	150	6.3	105	90	6	70	1400	1000	600	-	3	3
TCJY157M006#0015E	Y	150	6.3	105	90	6	15	3500	2500	1600	-	2	3
TCJY157M006#0025E	Y	150	6.3	105	90	6	25	2700	1900	1200	-	2	3
TCJY157M006#0040E	Y	150	6.3	105	90	6	40	2200	1500	1000	-	3	3
TCJB227M006#0070E	B	220	6.3	105	132	10	70	1300	900	600	-	3	3
TCJB227M006#0200E	B	220	6.3	105	132	10	200	800	600	400	-	3	3

TCJ Series

Conductive Polymer Solid Electrolytic Chip Capacitors



RATINGS & PART NUMBER REFERENCE

AVX Part No.	Case Size	Capacitance (µF)	Rated Voltage (V)	Maximum Operating Temperature (°C)	DCL Max. (µA)	DF Max. (%)	ESR Max. @ 100kHz (mΩ)	100kHz RMS Current (mA)				Product Category	MSL
								45°C	85°C	105°C	125°C		
TCJD227M006#0012E	D	220	6.3	105	132	6	12	4300	3000	1900	-	2	3
TCJD227M006#0015E	D	220	6.3	105	132	6	15	3900	2700	1800	-	2	3
TCJD227M006#0025E	D	220	6.3	105	132	6	25	3000	2100	1400	-	2	3
TCJD227M006#0035E	D	220	6.3	105	132	6	35	2500	1800	1100	-	3	3
TCJD227M006#0040E	D	220	6.3	105	132	6	40	2400	1700	1100	-	3	3
TCJD227M006#0050E	D	220	6.3	105	132	6	50	2100	1500	900	-	3	3
TCJH227M006#0170E	H	220	6.3	105	132	10	170	800	600	400	-	3	3
TCJY227M006#0015E	Y	220	6.3	85	132	6	15	3500	2500	-	-	5	3
TCJY227M006#0018E	Y	220	6.3	105	132	6	18	3200	2200	1400	-	3	3
TCJY227M006#0025E	Y	220	6.3	105	132	6	25	2700	1900	1200	-	2	3
TCJY227M006#0035E	Y	220	6.3	105	132	6	35	2300	1600	1000	-	2	3
TCJY227M006#0040E	Y	220	6.3	105	132	6	40	2200	1500	1000	-	2	3
TCJY227M006#0050E	Y	220	6.3	105	132	6	50	1900	1300	900	-	2	3
TCJD337M006#0012E	D	330	6.3	105	198	6	12	4300	3000	1900	-	3	3
TCJD337M006#0015E	D	330	6.3	105	198	6	15	3900	2700	1800	-	3	3
TCJD337M006#0018E	D	330	6.3	105	198	6	18	3500	2500	1600	-	3	3
TCJD337M006#0025E	D	330	6.3	105	198	6	25	3000	2100	1400	-	3	3
TCJD337M006#0040E	D	330	6.3	105	198	6	40	2400	1700	1100	-	2	3
TCJD337M006#0050E	D	330	6.3	105	198	6	50	2100	1500	900	-	2	3
TCJY337M006#0015E	Y	330	6.3	85	198	12	15	3500	2500	-	-	5	3
TCJY337M006#0025E	Y	330	6.3	105	198	12	25	2700	1900	1200	-	3	3
TCJY337M006#0040E	Y	330	6.3	105	198	12	40	2200	1500	1000	-	3	3
TCJY337M006#0050E	Y	330	6.3	105	198	12	50	1900	1300	900	-	3	3
TCJD477M006#0025E	D	470	6.3	105	282	6	25	3000	2100	1400	-	2	3
TCJX477M006#0035E	X	470	6.3	105	282	6	35	2200	1500	1000	-	3	3
TCJX477M006#0050E	X	470	6.3	105	282	6	50	1900	1300	900	-	3	3
TCJX477M006#0100E	X	470	6.3	105	282	6	100	1300	900	600	-	3	3
10 Volt @ 85°C													
TCJK475M010#0300E	K	4.7	10	105	4.7	6	300	500	400	200	-	3	3
TCJK475M010#0500E	K	4.7	10	105	4.7	6	500	400	300	200	-	3	3
TCJR475M010#0500E	R	4.7	10	105	4.7	6	500	400	300	200	-	3	3
TCJA106M010#0200E	A	10	10	125	10	6	200	700	500	300	200	1	3
TCJA106M010#0300E	A	10	10	125	10	6	300	600	400	300	200	1	3
TCJA156M010#0200E	A	15	10	125	15	6	200	700	500	300	200	1	3
TCJB226M010#0070E	B	22	10	125	22	6	70	1300	900	600	300	0	3
TCJB226M010#0300E	B	22	10	125	22	6	300	600	400	300	200	0	3
TCJT226M010#0070E	T	22	10	105	22	6	70	1200	800	500	-	3	3
TCJT226M010#0150E	T	22	10	105	22	6	150	800	600	400	-	3	3
TCJB336M010#0070E	B	33	10	125	33	6	70	1300	900	600	300	0	3
TCJB336M010#0200E	B	33	10	125	33	6	200	800	600	400	200	0	3
TCJC336M010#0100E	C	33	10	125	33	6	100	1300	900	600	300	1	3
TCJT336M010#0070E	T	33	10	105	33	6	70	1200	800	500	-	3	3
TCJT336M010#0150E	T	33	10	105	33	6	150	800	600	400	-	3	3
TCJB476M010#0070E	B	47	10	105	47	6	70	1300	900	600	-	3	3
TCJC476M010#0100E	C	47	10	125	47	6	100	1300	900	600	300	1	3
TCJH476M010#0100E	H	47	10	105	47	6	100	1000	700	500	-	3	3
TCJD686M010#0045E	D	68	10	125	68	6	45	2200	1500	1000	600	0	3
TCJD686M010#0055E	D	68	10	125	68	6	55	2000	1400	900	500	0	3
TCJY686M010#0045E	Y	68	10	105	68	6	45	2000	1400	900	-	3	3
TCJY686M010#0055E	Y	68	10	105	68	6	55	1800	1300	800	-	3	3
TCJD107M010#0018E	D	100	10	105	100	6	18	3500	2500	1600	-	2	3
TCJD107M010#0025E	D	100	10	105	100	6	25	3000	2100	1400	-	2	3
TCJD107M010#0045E	D	100	10	105	100	6	45	2200	1500	1000	-	3	3
TCJD107M010#0055E	D	100	10	105	100	6	55	2000	1400	900	-	3	3
TCJD107M010#0080E	D	100	10	105	100	6	80	1700	1200	800	-	3	3
TCJY107M010#0018E	Y	100	10	105	100	6	18	3200	2200	1400	-	2	3
TCJY107M010#0025E	Y	100	10	105	100	6	25	2700	1900	1200	-	2	3
TCJY107M010#0045E	Y	100	10	105	100	6	45	2000	1400	900	-	3	3
TCJY107M010#0055E	Y	100	10	105	100	6	55	1800	1300	800	-	3	3
TCJD157M010#0025E	D	150	10	105	150	6	25	3000	2100	1400	-	3	3
TCJD157M010#0040E	D	150	10	105	150	6	40	2400	1700	1100	-	3	3
TCJD157M010#0045E	D	150	10	105	150	6	45	2200	1500	1000	-	3	3
TCJD157M010#0055E	D	150	10	105	150	6	55	2000	1400	900	-	3	3
TCJY157M010#0025E	Y	150	10	105	150	6	25	2700	1900	1200	-	3	3
TCJY157M010#0040E	Y	150	10	105	150	6	40	2200	1500	1000	-	3	3
TCJY157M010#0045E	Y	150	10	105	150	6	45	2000	1400	900	-	3	3
TCJY157M010#0055E	Y	150	10	105	150	6	55	1800	1300	800	-	3	3
TCJD227M010#0012E	D	220	10	105	220	6	12	4300	3000	1900	-	3	3
TCJD227M010#0015E	D	220	10	105	220	6	15	3900	2700	1800	-	3	3
TCJD227M010#0025E	D	220	10	105	220	6	25	3000	2100	1400	-	3	3



The Important Information/Disclaimer is incorporated in the catalog where these specifications came from or available online at www.avx.com/disclaimer/ by reference and should be reviewed in full before placing any order.

RATINGS & PART NUMBER REFERENCE

AVX Part No.	Case Size	Capacitance (μF)	Rated Voltage (V)	Maximum Operating Temperature (°C)	DCL Max. (μA)	DF Max. (%)	ESR Max. @ 100kHz (mΩ)	100kHz RMS Current (mA)				Product Category	MSL
								45°C	85°C	105°C	125°C		
TCJD227M010#0040E	D	220	10	105	220	6	40	2400	1700	1100	-	3	3
TCJD227M010#0050E	D	220	10	105	220	6	50	2100	1500	900	-	3	3
TCJY227M010#0015E	Y	220	10	85	220	6	15	3500	2500	-	-	5	3
TCJY227M010#0025E	Y	220	10	105	220	6	25	2700	1900	1200	-	3	3
TCJY227M010#0040E	Y	220	10	105	220	6	40	2200	1500	1000	-	3	3
TCJY227M010#0050E	Y	220	10	105	220	6	50	1900	1300	900	-	3	3
TCJD337M010#0025E	D	330	10	105	330	6	25	3000	2100	1400	-	2	3
TCJ5337M010#0035E	5	330	10	105	330	10	35	2600	1800	1200	-	2	3
TCJ5337M010#0100E	5	330	10	105	330	10	100	1500	1100	700	-	2	3
16 Volt @ 85°C													
TCJA685M016#0200E	A	6.8	16	125	10.9	6	200	700	500	300	200	1	3
TCJA106M016#0200E	A	10	16	125	16	6	200	700	500	300	200	1	3
TCJB106M016#0100E	B	10	16	125	16	6	100	1100	800	500	300	1	3
TCJB106M016#0200E	B	10	16	125	16	6	200	800	600	400	200	1	3
TCJT106M016#0100E	T	10	16	125	16	6	100	1000	700	500	300	1	3
TCJT106M016#0150E	T	10	16	125	16	6	150	800	600	400	200	1	3
TCJT106M016#0200E	T	10	16	125	16	6	200	700	500	300	200	1	3
TCJB156M016#0090E	B	15	16	125	24	6	90	1200	800	500	300	0	3
TCJB156M016#0150E	B	15	16	125	24	6	150	900	600	400	200	0	3
TCJA226M016#0300E	A	22	16	105	35.2	10	300	600	400	300	-	3	3
TCJB226M016#0070E	B	22	16	125	35.2	8	70	1300	900	600	300	0	3
TCJB226M016#0150E	B	22	16	125	35.2	6	150	900	600	400	200	0	3
TCJA336M016#0200E	A	33	16	105	52.8	10	200	700	500	300	-	3	3
TCJH336M016#0150E	H	33	16	105	52.8	6	150	800	600	400	-	3	3
TCJY336M016#0045E	Y	33	16	105	52.8	6	45	2000	1400	900	-	2	3
TCJY336M016#0060E	Y	33	16	105	52.8	6	60	1800	1300	800	-	2	3
TCJY336M016#0070E	Y	33	16	105	52.8	6	70	1600	1100	700	-	2	3
TCJD476M016#0045E	D	47	16	125	75.2	6	45	2200	1500	1000	600	0	3
TCJD476M016#0070E	D	47	16	125	75.2	6	70	1800	1300	800	500	0	3
TCJH476M016#0150E	H	47	16	105	75.2	6	150	800	600	400	-	3	4
TCJX476M016#0045E	X	47	16	105	75.2	6	45	2000	1400	900	-	2	3
TCJX476M016#0070E	X	47	16	105	75.2	6	70	1600	1100	700	-	2	3
TCJY476M016#0045E	Y	47	16	105	75.2	6	45	2000	1400	900	-	2	3
TCJY476M016#0070E	Y	47	16	105	75.2	6	70	1600	1100	700	-	2	3
TCJD686M016#0050E	D	68	16	105	108.8	6	50	2100	1500	900	-	2	3
TCJY686M016#0050E	Y	68	16	105	108.8	6	50	1900	1300	900	-	2	3
TCJD107M016#0050E	D	100	16	105	160	6	50	2100	1500	900	-	2	3
TCJE107M016#0040E	E	100	16	105	160	6	40	2500	1800	1100	-	2	3
TCJY107M016#0050E	Y	100	16	105	160	6	50	1900	1300	900	-	2	3
TCJC157M016#0070E	C	150	16	125	240	10	70	1600	1100	700	400	0	3
TCJD157M016#0040E	D	150	16	85	240	6	40	2400	1700	-	-	5	3
TCJD157M016#0050E	D	150	16	85	240	6	50	2100	1500	-	-	5	3
TCJD157M016#0070E	D	150	16	105	240	6	70	1800	1300	800	-	3	3
TCJE157M016#0040E	E	150	16	125	240	10	40	2500	1800	1100	600	0	3
TCJY157M016#0040E	Y	150	16	105	240	6	40	2200	1500	1000	-	3	3
TCJY157M016#0050E	Y	150	16	105	240	6	50	1900	1300	900	-	3	3
TCJY157M016#0070E	Y	150	16	105	240	6	70	1600	1100	700	-	3	3
TCJD227M016#0035E	D	220	16	105	352	10	35	2500	1800	1100	-	2	3
TCJD227M016#0050E	D	220	16	105	352	10	50	2100	1500	900	-	2	3
TCJE227M016#0050E	E	220	16	125	352	10	50	2200	1500	1000	600	0	3
TCJE337M016#0035E	E	330	16	105	528	10	35	2700	1900	1200	-	2	3
TCJE337M016#0050E	E	330	16	105	528	10	50	2200	1500	1000	-	2	3
TCJE337M016#0070E	E	330	16	105	528	10	70	1900	1300	900	-	2	3
TCJ5337M016#0100E	5	330	16	105	528	10	100	1500	1100	700	-	2	3
TCJ5477M016R0100E	5	470	16	105	752	10	100	1500	1100	700	-	3	3
20 Volt @ 85°C													
TCJA106M020#0150E	A	10	20	105	20	6	150	800	600	400	-	3	3
TCJB106M020#0150E	B	10	20	125	20	8	150	900	600	400	200	0	3
TCJB156M020#0150E	B	15	20	125	30	8	150	900	600	400	200	0	3
TCJB226M020#0090E	B	22	20	105	44	6	90	1200	800	500	-	3	3
TCJB226M020#0150E	B	22	20	105	44	6	150	900	600	400	-	3	3
TCJX226M020#0100E	X	22	20	105	44	8	100	1300	900	600	-	2	3
TCJY226M020#0070E	Y	22	20	105	44	6	70	1600	1100	700	-	2	3
TCJX336M020#0100E	X	33	20	105	66	6	100	1300	900	600	-	2	3
TCJY336M020#0070E	Y	33	20	105	66	6	70	1600	1100	700	-	2	3
TCJD476M020#0055E	D	47	20	105	94	6	55	2000	1400	900	-	2	3
TCJX476M020#0055E	X	47	20	105	94	6	55	1800	1300	800	-	3	3
TCJX476M020#0070E	X	47	20	105	94	6	70	1600	1100	700	-	3	3
TCJY476M020#0070E	Y	47	20	125	94	6	70	1600	1100	700	400	0	3

TCJ Series

Conductive Polymer Solid Electrolytic Chip Capacitors



RATINGS & PART NUMBER REFERENCE

AVX Part No.	Case Size	Capacitance (µF)	Rated Voltage (V)	Maximum Operating Temperature (°C)	DCL Max. (µA)	DF Max. (%)	ESR Max. @ 100kHz (mΩ)	100kHz RMS Current (mA)				Product Category	MSL
								45°C	85°C	105°C	125°C		
TCJD686M020#0055E	D	68	20	105	136	6	55	2000	1400	900	-	3	3
TCJE686M020#0045E	E	68	20	105	136	6	45	2400	1700	1100	-	2	3
TCJY686M020#0050E	Y	68	20	105	136	6	50	1900	1300	900	-	2	3
TCJC107M020#0070E	C	100	20	125	200	10	70	1600	1100	700	400	0	3
TCJD107M020#0055E	D	100	20	105	200	6	55	2000	1400	900	-	2	3
TCJE107M020#0045E	E	100	20	125	200	10	45	2400	1700	1100	600	0	3
TCJY107M020#0055E	Y	100	20	105	200	6	55	1800	1300	800	-	2	3
TCJU227M020R0070E	U	220	20	105	440	12	70	2300	1600	1000	-	2	3
25 Volt @ 85°C													
TCJP105M025#0500E	P	1.0	25	105	2.5	6	500	400	300	200	-	2	3
TCJB475M025#0100E	B	4.7	25	105	11.8	6	100	1100	800	500	-	3	3
TCJB475M025#0150E	B	4.7	25	105	11.8	6	150	900	600	400	-	3	3
TCJA685M025#0150E	A	6.8	25	105	17	6	150	800	600	400	-	3	3
TCJB685M025#0090E	B	6.8	25	105	17	6	90	1200	800	500	-	2	3
TCJB685M025#0150E	B	6.8	25	105	17	6	150	900	600	400	-	3	3
TCJT685M025#0100E	T	6.8	25	105	17	6	100	1000	700	500	-	3	3
TCJT685M025#0150E	T	6.8	25	105	17	6	150	800	600	400	-	3	3
TCJA106M025#0150E	A	10	25	105	25	6	150	800	600	400	-	3	3
TCJB106M025#0090E	B	10	25	105	25	6	90	1200	800	500	-	2	3
TCJB106M025#0100E	B	10	25	105	25	6	100	1100	800	500	-	2	3
TCJB106M025#0150E	B	10	25	105	25	6	150	900	600	400	-	2	3
TCJB156M025#0100E	B	15	25	105	37.5	6	100	1400	1400	900	-	2	3
TCJB156M025#0150E	B	15	25	105	37.5	6	150	900	600	400	-	2	3
TCJY156M025#0090E	Y	15	25	105	37.5	6	90	1400	1000	600	-	2	3
TCJB226M025#0100E	B	22	25	105	55	6	100	1100	800	500	-	2	3
TCJB226M025#0150E	B	22	25	105	55	6	150	900	600	400	-	2	3
TCJC226M025#0100E	C	22	25	105	55	6	100	1300	900	600	-	3	3
TCJD226M025#0060E	D	22	25	105	55	6	60	1900	1300	900	-	2	3
TCJD226M025#0100E	D	22	25	105	55	6	100	1500	1100	700	-	2	3
TCJX226M025#0100E	X	22	25	105	55	8	100	1300	900	600	-	2	3
TCJY226M025#0070E	Y	22	25	105	55	6	70	1600	1100	700	-	3	3
TCJD336M025#0060E	D	33	25	105	82.5	6	60	1900	1300	900	-	2	3
TCJD336M025#0100E	D	33	25	105	82.5	6	100	1500	1100	700	-	2	3
TCJX336M025#0070E	X	33	25	105	82.5	6	70	1600	1100	700	-	2	3
TCJX336M025#0100E	X	33	25	105	82.5	6	100	1300	900	600	-	2	3
TCJY336M025#0060E	Y	33	25	105	82.5	6	60	1800	1300	800	-	2	3
TCJY336M025#0070E	Y	33	25	105	82.5	6	70	1600	1100	700	-	2	3
TCJY336M025#0100E	Y	33	25	105	82.5	6	100	1400	1000	600	-	2	3
TCJD476M025#0060E	D	47	25	105	117.5	6	60	1900	1300	900	-	3	3
TCJD476M025#0100E	D	47	25	105	117.5	6	100	1500	1100	700	-	3	3
TCJE476M025#0050E	E	47	25	105	117.5	6	50	2200	1500	1000	-	3	3
TCJY476M025#0100E	Y	47	25	105	117.5	6	100	1400	1000	600	-	3	3
TCJD686M025#0070E	D	68	25	105	170	6	70	1800	1300	800	-	2	3
TCJE686M025#0050E	E	68	25	105	170	6	50	2200	1500	1000	-	3	3
TCJY686M025#0100E	Y	68	25	105	170	6	100	1400	1000	600	-	3	3
TCJD107M025#0055E	D	100	25	105	250	6	55	2000	1400	900	-	2	3
TCJD107M025#0070E	D	100	25	105	250	6	70	1800	1300	800	-	2	3
TCJE107M025#0080E	E	100	25	105	250	6	80	1800	1300	800	-	2	3
TCJU107M025R0070E	U	100	25	125	250	12	70	2300	1600	1000	600	1	3
TCJU157M025R0070E	U	150	25	105	375	12	70	2300	1600	1000	-	2	3
35 Volt @ 85°C													
TCJB155M035#0200E	B	1.5	35	105	5.3	6	200	800	600	400	-	2	3
TCJB225M035#0200E	B	2.2	35	105	7.7	6	200	800	600	400	-	3	3
TCJB335M035#0200E	B	3.3	35	105	11.6	6	200	800	600	400	-	3	3
TCJB475M035#0200E	B	4.7	35	105	16.5	6	200	800	600	400	-	3	3
TCJC475M035#0200E	C	4.7	35	105	16.5	6	200	900	600	400	-	3	3
TCJC685M035#0200E	C	6.8	35	105	23.8	6	200	900	600	400	-	3	3
TCJB106M035#0200E	B	10	35	105	35	6	200	800	600	400	-	2	3
TCJC106M035#0200E	C	10	35	105	35	6	200	900	600	400	-	3	3
TCJY106M035#0070E	Y	10	35	105	35	6	70	1600	1100	700	-	2	3
TCJB156M035#0200E	B	15	35	105	52.5	6	200	800	600	400	-	2	3
TCJC156M035#0200E	C	15	35	105	52.5	6	200	900	600	400	-	3	3
TCJD156M035#0070E	D	15	35	105	52.5	6	70	1800	1300	800	-	3	3
TCJD156M035#0100E	D	15	35	105	52.5	6	100	1500	1100	700	-	3	3
TCJY156M035#0070E	Y	15	35	105	52.5	6	70	1600	1100	700	-	3	3
TCJY156M035#0100E	Y	15	35	105	52.5	6	100	1400	1000	600	-	3	3
TCJD226M035#0070E	D	22	35	105	77	6	70	1800	1300	800	-	2	3
TCJD226M035#0100E	D	22	35	105	77	6	100	1500	1100	700	-	2	3
TCJY226M035#0150E	Y	22	35	105	77	6	150	1100	800	500	-	3	3



The Important Information/Disclaimer is incorporated in the catalog where these specifications came from or available online at www.avx.com/disclaimer/ by reference and should be reviewed in full before placing any order.

RATINGS & PART NUMBER REFERENCE

AVX Part No.	Case Size	Capacitance (µF)	Rated Voltage (V)	Maximum Operating Temperature (°C)	DCL Max. (µA)	DF Max. (%)	ESR Max. @ 100kHz (mΩ)	100kHz RMS Current (mA)				Product Category	MSL
								45°C	85°C	105°C	125°C		
TCJD336M035#0070E	D	33	35	105	115.5	6	70	1800	1300	800	-	2	3
TCJD336M035#0100E	D	33	35	105	115.5	6	100	1500	1100	700	-	2	3
TCJE336M035#0055E	E	33	35	105	115.5	6	55	2100	1500	900	-	3	3
TCJE336M035#0070E	E	33	35	105	115.5	6	70	1900	1300	900	-	3	3
TCJU336M035R0070E	U	33	35	125	115.5	12	70	2300	1600	1000	600	1	3
TCJY336M035#0100E	Y	33	35	105	115.5	6	100	1400	1000	600	-	3	3
TCJE476M035#0055E	E	47	35	105	164.5	6	55	2100	1500	900	-	2	3
TCJU476M035R0070E	U	47	35	125	164.5	12	70	2300	1600	1000	600	1	3
TCJY476M035#0100E	Y	47	35	105	164.5	6	100	1400	1000	600	-	3	3
50 Volt @ 85°C													
TCJB684M050#0400E	B	0.68	50	105	3.4	6	400	600	400	300	-	3	3
TCJB105M050#0300E	B	1.0	50	105	5	6	300	600	400	300	-	3	3
TCJB155M050#0300E	B	1.5	50	105	7.5	6	300	600	400	300	-	3	3
TCJC155M050#0300E	C	1.5	50	105	7.5	6	300	800	600	400	-	3	3
TCJC225M050#0300E	C	2.2	50	105	11	6	300	800	600	400	-	3	3
TCJC335M050#0200E	C	3.3	50	105	16.5	8	200	900	600	400	-	3	3
TCJC475M050#0200E	C	4.7	50	105	23.5	8	200	900	600	400	-	3	3
TCJX475M050#0250E	X	4.7	50	105	23.5	6	250	800	600	400	-	2	5
TCJY475M050#0250E	Y	4.7	50	105	23.5	6	250	900	600	400	-	2	5
TCJC685M050#0200E	C	6.8	50	105	34	8	200	900	600	400	-	3	3
TCJD685M050#0120E	D	6.8	50	105	34	10	120	1400	1000	600	-	3	3
TCJD106M050#0090E	D	10	50	105	50	10	90	1600	1100	700	-	3	3
TCJD106M050#0120E	D	10	50	105	50	10	120	1400	1000	600	-	3	3
TCJE106M050#0070E	E	10	50	105	50	6	70	1900	1300	900	-	3	3
TCJE106M050#0100E	E	10	50	105	50	6	100	1600	1100	700	-	3	3
TCJD156M050#0150E	D	15	50	125	75	8	150	1200	800	500	300	1	3
TCJE156M050#0070E	E	15	50	105	75	6	70	1900	1300	900	-	3	3
TCJE156M050#0100E	E	15	50	105	75	6	100	1600	1100	700	-	3	3
TCJD226M050#0090E	D	22	50	125	110	8	90	1600	1100	700	400	1	3
TCJE226M050#0075E	E	22	50	125	110	8	75	1800	1300	800	500	1	3
TCJE226M050#0150E	E	22	50	105	110	8	150	1300	900	600	-	2	3
63 Volt @ 85°C													
TCJB474M063#0400E	B	0.47	63	105	3	8	400	600	400	300	-	3	3
TCJB684M063#0300E	B	0.68	63	105	4.3	8	300	600	400	300	-	3	3
TCJB105M063#0300E	B	1.0	63	105	6.3	8	300	600	400	300	-	3	3
TCJC105M063#0300E	C	1.0	63	105	6.3	6	300	800	600	400	-	3	3
TCJC155M063#0300E	C	1.5	63	105	9.5	6	300	800	600	400	-	3	3
TCJC225M063#0200E	C	2.2	63	105	13.9	6	200	900	600	400	-	3	3
TCJC335M063#0200E	C	3.3	63	105	20.8	6	200	900	600	400	-	3	3
TCJC475M063#0200E	C	4.7	63	105	29.6	6	200	900	600	400	-	3	3
TCJD475M063#0120E	D	4.7	63	105	29.6	6	120	1400	1000	600	-	3	3
TCJD685M063#0120E	D	6.8	63	105	42.8	6	120	1400	1000	600	-	3	3
TCJE685M063#0100E	E	6.8	63	105	42.8	6	100	1600	1100	700	-	3	3
TCJE685M063#0150E	E	6.8	63	105	42.8	6	150	1300	900	600	-	3	3
TCJE106M063#0100E	E	10	63	105	63	6	100	1600	1100	700	-	3	3
TCJE106M063#0150E	E	10	63	105	63	6	150	1300	900	600	-	3	3
TCJE156M063#0150E	E	15	63	105	94.5	8	150	1300	900	600	-	2	3
75 Volt @ 85°C													
TCJD475M075#0150E	D	4.7	75	105	35.3	6	150	1200	800	500	-	3	3
TCJD685M075#0120E	D	6.8	75	105	51	6	120	1400	1000	600	-	3	3
100 Volt @ 85°C													
TCJD475M100#0250E	D	4.7	100	105	47	8	250	900	600	400	-	4	3
125 Volt @ 85°C													
TCJD335M125#0250E	D	3.3	125	105	41.2	8	250	900	600	400	-	4	3

Moisture Sensitivity Level (MSL) is defined according to J-STD-020.

All technical data relates to an ambient temperature of +25°C. Capacitance and DF are measured at 120Hz, 0.5RMS

with DC bias of 2.2 volts. DCL is measured at rated voltage after 5 minutes.

ESR allowed to move up to 1.25 times catalog limit post mounting.

For typical weight and composition see page 276.

NOTE: AVX reserves the right to supply higher voltage ratings or tighter tolerance part in the same case size, to the same reliability standards.

RECOMMENDED DERATING FACTOR

Voltage and temperature derating as percentage of Vr

Product Category 0

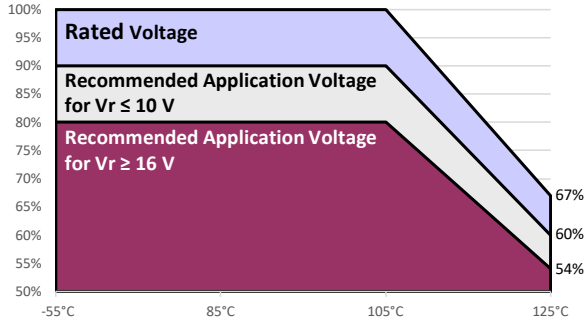

Product Category 1

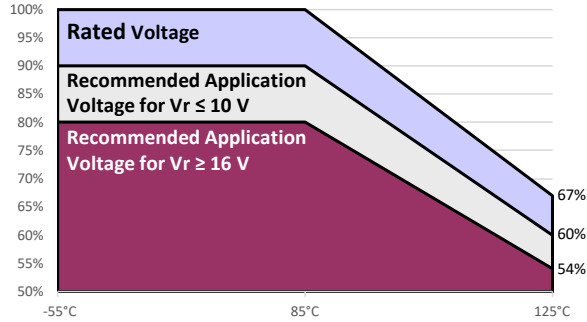

Product Category 2

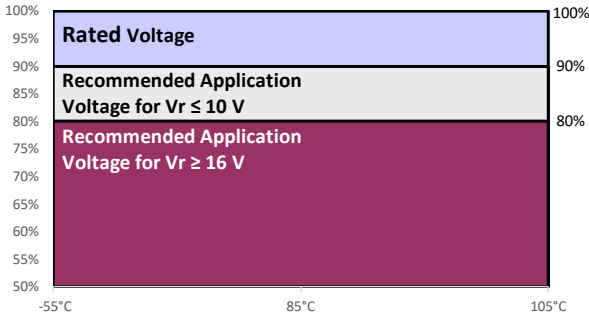

Product Category 3, 4

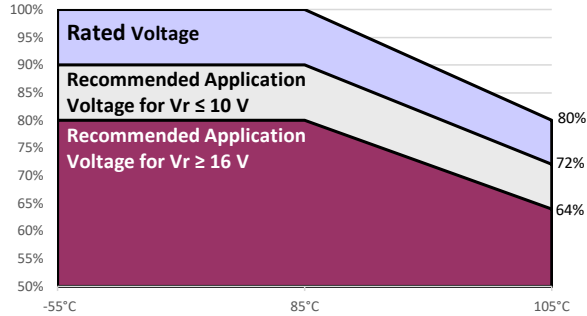

Product Category 5

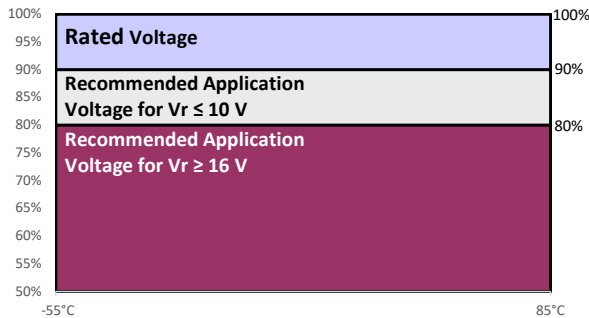

PRODUCT CATEGORY 0, 1 (TEMPERATURE RANGE -55°C TO +125°C)

TEST	Condition			Characteristics							
Endurance	Apply rated voltage (Ur) at 85°C (CATEGORY 1) or 105°C (CATEGORY 0) or 2/3 rated voltage (Ur) at 125°C (all CATEGORIES) for 2000 hours through a circuit impedance of $\leq 0.1\Omega/V$. Stabilize at room temperature for 1-2 hours before measuring.			Visual examination	no visible damage						
				DCL	1.25 x initial limit						
				$\Delta C/C$	within +10/-20% of initial value						
				DF	1.5 x initial limit						
				ESR	2 x initial limit						
Storage Life	Store at 125°C, no voltage applied, for 2000 hours. Stabilize at room temperature for 1-2 hours before measuring.			Visual examination	no visible damage						
				DCL	2 x initial limit						
				$\Delta C/C$	within +10/-20% of initial value						
				DF	1.5 x initial limit						
				ESR	2 x initial limit						
Humidity	Store at 65°C and 95% relative humidity for 500 hours, with no applied voltage. Stabilize at room temperature and humidity for 1-2 hours before measuring.			Visual examination	no visible damage						
				DCL	3 x initial limit						
				$\Delta C/C$	within +35/-5% of initial value						
				DF	1.5 x initial limit						
				ESR	2 x initial limit						
Temperature Stability	Step	Temperature °C	Duration (min)		+20°C	-55°C	+20°C	+85°C	+125°C	+20°C	
	1	+20	15	DCL	IL*	n/a	IL*	10 x IL*	12.5 x IL*	IL*	
	2	-55	15								
	3	+20	15	$\Delta C/C$	n/a	+0/-20%	$\pm 5\%$	+20/-0%	+30/-0%	$\pm 5\%$	
	4	+85	15	DF	IL*	1.5 x IL*	IL*	1.5 x IL*	2 x IL*	IL*	
	5	+125	15								
6	+20	15									
Surge Voltage	Apply 1.3x 2/3x rated voltage (Ur) at 125°C for 1000 cycles of duration 6 min (30 sec charge, 5 min 30 sec discharge) through a charge / discharge resistance of 1000 Ω			Visual examination	no visible damage						
				DCL	initial limit						
				$\Delta C/C$	within +10/-20% of initial value						
				DF	1.25 x initial limit						
				ESR	initial limit						
Mechanical Shock	MIL-STD-202, Method 213, Condition C			Visual examination	no visible damage						
				DCL	initial limit						
				$\Delta C/C$	within $\pm 5\%$ of initial value						
				DF	initial limit						
				ESR	initial limit						
Vibration	MIL-STD-202, Method 204, Condition D			Visual examination	no visible damage						
				DCL	initial limit						
				$\Delta C/C$	within $\pm 5\%$ of initial value						
				DF	initial limit						
				ESR	initial limit						

*Initial Limit

Initial measurement max. 1hr after the removal from dry pack or after pretreatment at 85°C for 24 hours.

PRODUCT CATEGORY 2, 3, 4 (TEMPERATURE RANGE -55°C TO +105°C)

TEST	Condition			Characteristics							
Endurance	Apply rated voltage (Ur) at 85°C for 2000 hours through a circuit impedance of $\leq 0.1\Omega/V$ (all CATEGORIES). And/or apply rated voltage (Ur) (CATEGORY 2) or 0.8x rated voltage (CATEGORY 3, 4) at 105°C for 2000 hours through a circuit impedance of $\leq 0.1\Omega/V$ Always stabilize at room temperature for 1-2 hours before measuring.			Visual examination	no visible damage						
				DCL	1.25 x initial limit						
				$\Delta C/C$	within +10/-20% of initial value						
				DF	1.5 x initial limit						
				ESR	2 x initial limit						
Storage Life	Store at 105°C, no voltage applied, for 2000 hours. Stabilize at room temperature for 1-2 hours before measuring.			Visual examination	no visible damage						
				DCL ($V_R \leq 75V$)	1.25 x initial limit						
				DCL ($V_R > 75V$)	2 x initial limit						
				$\Delta C/C$	within +10/-20% of initial value						
				DF	1.5 x initial limit						
				ESR	2 x initial limit						
Humidity	Store at 65°C and 95% relative humidity for 500 hours, with no applied voltage. Stabilize at room temperature and humidity for 1-2 hours before measuring.			Visual examination	no visible damage						
				DCL	3 x initial limit						
				$\Delta C/C$	within +35/-5% of initial value						
				DF	1.5 x initial limit						
				ESR	2 x initial limit						
Temperature Stability	Step	Temperature °C	Duration (min)		+20°C	-55°C	+20°C	+85°C	+105°C	+20°C	
	1	+20	15	DCL	IL*	n/a	IL*	10 x IL*	12.5 x IL*	IL*	
	2	-55	15								
	3	+20	15	$\Delta C/C$	n/a	+0/-20%	$\pm 5\%$	+20/-0%	+30/-0%	$\pm 5\%$	
	4	+85	15	DF	IL*	1.5 x IL*	IL*	1.5 x IL*	2 x IL*	IL*	
	5	+105	15								
6	+20	15									
Surge Voltage	Apply 1.3x rated voltage (Ur) at 105°C for CATEGORY 2, or apply 1.3x 0.8x rated voltage (Ur) at 105°C for CATEGORY 3, 4 for 1000 cycles of duration 6 min (30 sec charge, 5 min 30 sec discharge) through a charge / discharge resistance of 1000 Ω			Visual examination	no visible damage						
				DCL	initial limit						
				$\Delta C/C$	within +10/-20% of initial value						
				DF	1.25 x initial limit						
				ESR	initial limit						
Mechanical Shock	MIL-STD-202, Method 213, Condition C			Visual examination	no visible damage						
				DCL	initial limit						
				$\Delta C/C$	within $\pm 5\%$ of initial value						
				DF	initial limit						
				ESR	initial limit						
Vibration	MIL-STD-202, Method 204, Condition D			Visual examination	no visible damage						
				DCL	initial limit						
				$\Delta C/C$	within $\pm 5\%$ of initial value						
				DF	initial limit						
				ESR	initial limit						

*Initial Limit

Initial measurement max. 1hr after the removal from dry pack or after pretreatment at 85°C for 24 hours.

PRODUCT CATEGORY 5 (TEMPERATURE RANGE -55°C TO +85°C)

TEST	Condition			Characteristics						
Endurance	Apply rated voltage (Ur) at 85°C for 2000 hours through a circuit impedance of $\leq 0.1\Omega/V$. Stabilize at room temperature for 1-2 hours before measuring.			Visual examination	no visible damage					
				DCL	1.25 x initial limit					
				$\Delta C/C$	within +10/-20% of initial value					
				DF	1.5 x initial limit					
				ESR	2 x initial limit					
Storage Life	Store at 85°C, no voltage applied, for 2000 hours. Stabilize at room temperature for 1-2 hours before measuring.			Visual examination	no visible damage					
				DCL	1.25 x initial limit					
				$\Delta C/C$	within +10/-20% of initial value					
				DF	1.5 x initial limit					
				ESR	2 x initial limit					
Humidity	Store at 65°C and 95% relative humidity for 500 hours, with no applied voltage. Stabilize at room temperature and humidity for 1-2 hours before measuring.			Visual examination	no visible damage					
				DCL	5 x initial limit					
				$\Delta C/C$	within +35/-5% of initial value					
				DF	1.5 x initial limit					
				ESR	2 x initial limit					
Temperature Stability	Step	Temperature°C	Duration(min)		+20°C	-55°C	+20°C	+85°C	+20°C	
	1	+20	15	DCL	IL*	n/a	IL*	10 x IL*	IL*	
	2	-55	15	$\Delta C/C$	n/a	+0/-20%	$\pm 5\%$	+20/-0%	$\pm 5\%$	
	3	+20	15	DF	IL*	1.5 x IL*	IL*	1.5 x IL*	IL*	
	4	+85	15							
	5	+125	15							
Surge Voltage	Apply 1.3x rated voltage (Ur) at 85°C for 1000 cycles of duration 6 min (30 sec charge, 5 min 30 sec discharge) through a charge / discharge resistance of 1000 Ω			Visual examination	no visible damage					
				DCL	initial limit					
				$\Delta C/C$	within +10/-20% of initial value					
				DF	1.25 x initial limit					
Mechanical Shock	MIL-STD-202, Method 213, Condition C			Visual examination	no visible damage					
				DCL	initial limit					
				$\Delta C/C$	within $\pm 5\%$ of initial value					
				DF	initial limit					
				ESR	initial limit					
Vibration	MIL-STD-202, Method 204, Condition D			Visual examination	no visible damage					
				DCL	initial limit					
				$\Delta C/C$	within $\pm 5\%$ of initial value					
				DF	initial limit					
				ESR	initial limit					

*Initial Limit

Initial measurement max. 1hr after the removal from dry pack or after pretreatment at 85°C for 24 hours.

TCJ Series

Conductive Polymer Solid Electrolytic Chip Capacitors

SOLID ELECTROLYTIC CAPACITOR ROADMAP

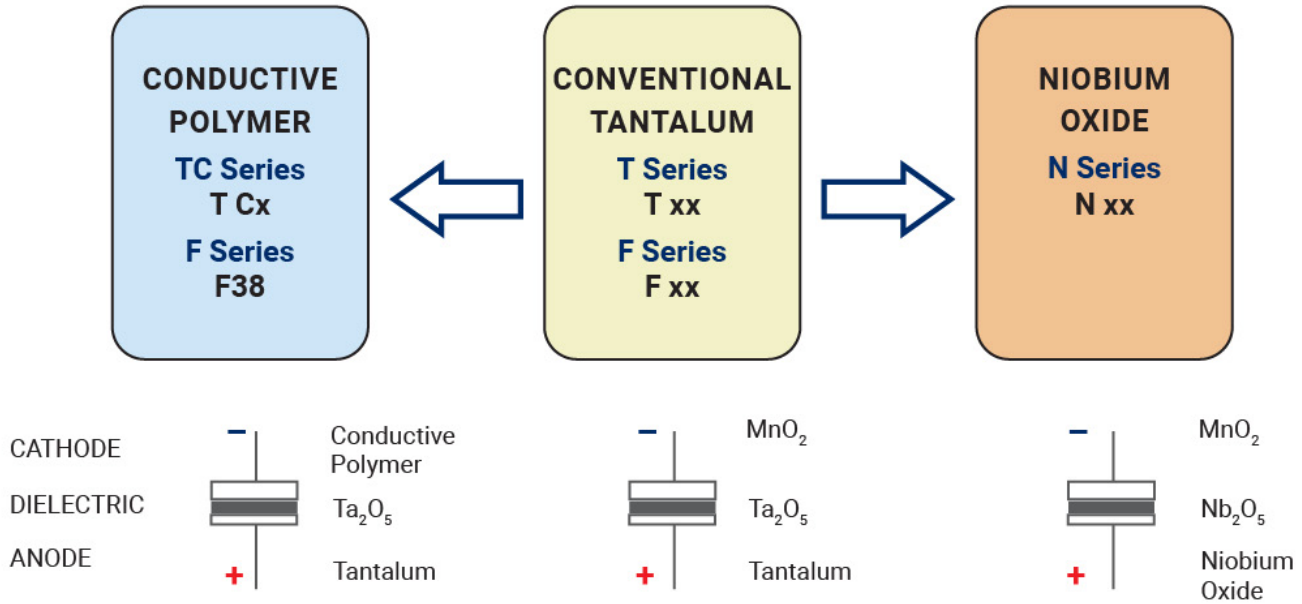

FIVE CAPACITOR CONSTRUCTION STYLES

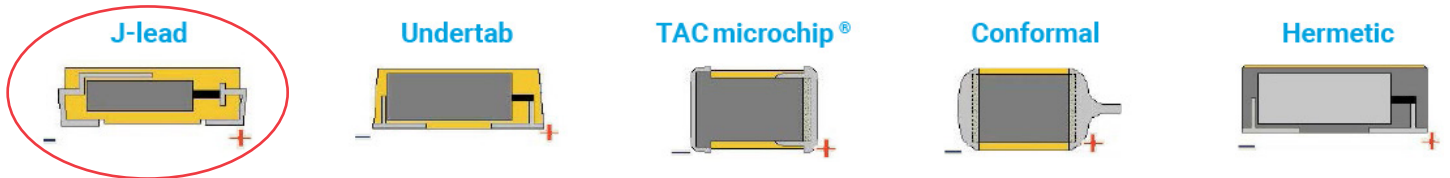

SERIES LINE UP : Conductive Polymer

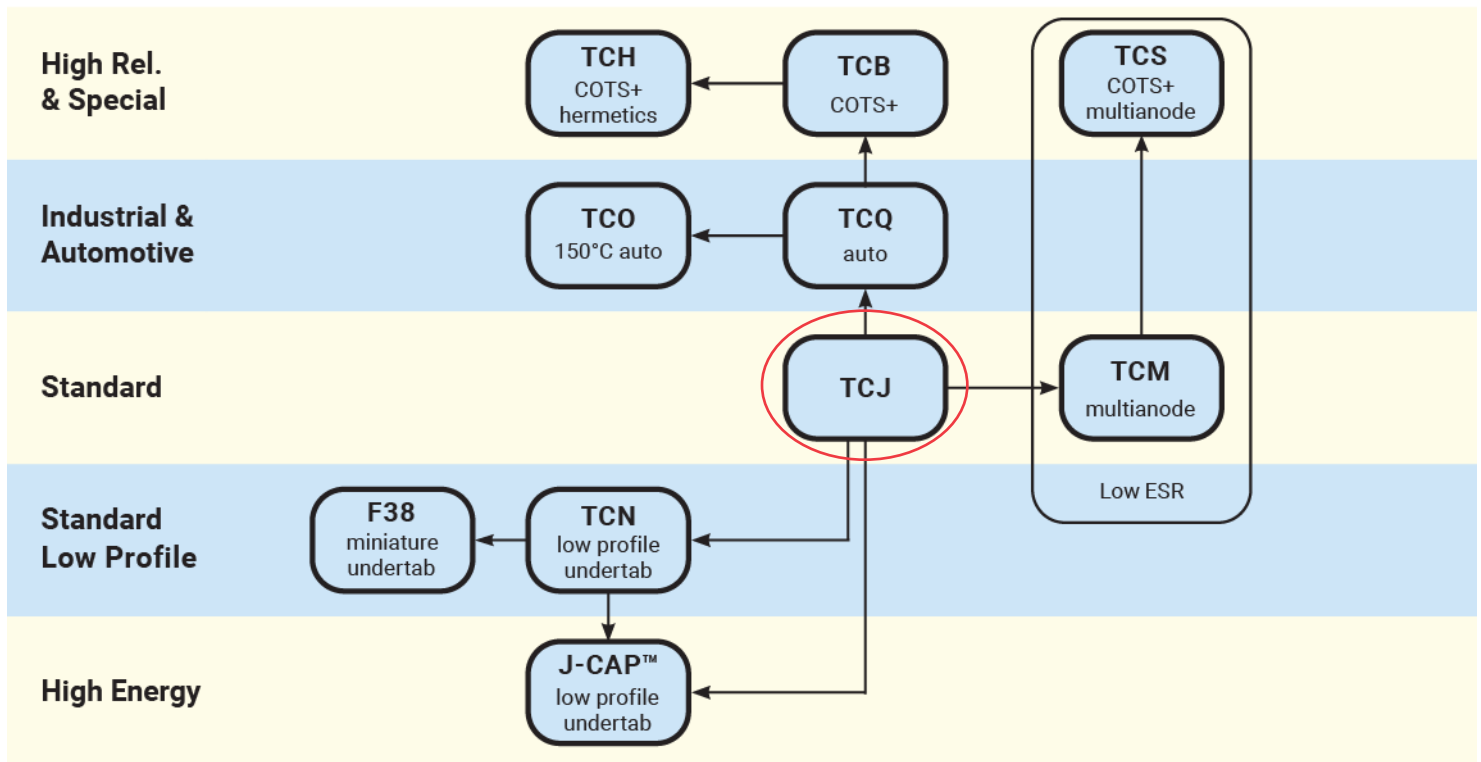

TCM Series

Conductive Polymer Solid Electrolytic Chip Multianode Capacitors

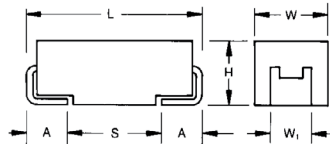

FEATURES

- Conductive Polymer Electrode, Multianode Design
- Benign Failure Mode Under Recommended Use Conditions
- Extremely Low ESR
- 3x Reflow 260°C Compatible
- 100% Surge Current Tested
- Volumetric Efficiency
- High Frequency Capacitance Retention



Elektra Award 2010



LEAD-FREE
LEAD-FREE COMPATIBLE COMPONENT



SnPb termination option is not RoHS compliant.

APPLICATIONS

- Telecommunication Routers
- Base Stations with High Power DC/DCs

MARKING

E, V CASE

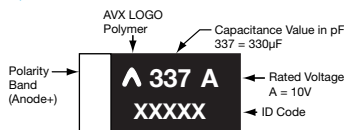

CASE DIMENSIONS:

millimeters (inches)

Code	EIA Code	EIA Metric	L±0.20 (0.008)	W±0.20 (0.008) -0.10 (0.004)	H±0.20 (0.008) -0.10 (0.004)	W ₁ ±0.20 (0.008)	A±0.30 (0.012) -0.20 (0.008)	S Min.
E	2917	7343-43	7.30 (0.287)	4.30 (0.169)	4.10 (0.162)	2.40 (0.094)	1.30 (0.051)	4.40 (0.173)
V	2924	7361-38	7.30 (0.287)	6.10 (0.240)	3.55 (0.140)	3.10 (0.122)	1.30 (0.051)	4.40 (0.173)

W₁ dimension applies to the termination width for A dimensional area only.

HOW TO ORDER

TCM

Type

E

Case Size
See table above

108

Capacitance Code
pF code: 1st two digits represent significant figures, 3rd digit represents multiplier (number of zeros to follow)

M

Tolerance
M = ±20%

004

Rated DC Voltage
002 = 2.5Vdc
004 = 4Vdc
006 = 6.3Vdc
010 = 10Vdc
016 = 16Vdc
020 = 20Vdc
025 = 25Vdc
035 = 35Vdc
050 = 50Vdc
100 = 100Vdc

R

Packaging
R = Pure Tin 7" Reel
S = Pure Tin 13" Reel
H = Tin Lead 7" Reel
K = Tin Lead 13" Reel

0010

ESR in mΩ

E

Additional Character
E = Black resin

TECHNICAL SPECIFICATIONS

Technical Data:	All technical data relate to an ambient temperature of +25°C
Capacitance Range:	10µF to 1000µF
Capacitance Tolerance:	±20%
Leakage Current DCL:	0.1CV
Temperature Range:	-55°C to +125°C
Termination Finish:	Sn Plating (standard) and SnPb Plating

NOTE: Conductive Polymer Capacitors are designed to operate within the limits of the environmental conditions specified for each series. If operated continuously at their maximum temperature and / or humidity limit, or beyond these limits, capacitors may exhibit a parametric shift in capacitance and increases in ESR. These changes may occur earlier if the specified environmental conditions are exceeded. Similarly, their normal operational time period will be significantly extended if their general duty cycle includes operation below maximum temperature within humidity controlled environments. Careful attention should be paid to maximum temperature with associated high humidity environments as well as voltage derating, ripple current and current surges. Please reference the AVX Conductive Polymer Capacitor Guidelines for more information or contact factory for application assistance.

TCM Series

Conductive Polymer Solid Electrolytic Chip Multianode Capacitors



CAPACITANCE AND RATED VOLTAGE RANGE (LETTER DENOTES CASE SIZE)

Capacitance		Rated Voltage DC (V _R) to 85°C									
µF	Code	2.5V (e)	4V (G)	6.3V (J)	10V (A)	16V (C)	20V (D)	25V (E)	35V (V)	50V (T)	100V (A)
10	106										V(50)
15	156									E(100)	
22	226								E(25)	E(75)	
33	336							E(60)	E(60)		
47	476							E(60)	E(45,60)		
68	686						E(25)	E(50)			
100	107					E(25)	E(25)				
150	157					E(25,40)					
220	227				E(25)	E(25,40)					
330	337			E(10,15)	E(10,15)	E(15, 25)					
470	477	E(10,12)	E(10,12)	E(7,10,12)	E(15, 25)						
680	687	E(10,12)	E(10,12)	E(12)							
1000	108	E(6,10,12)	E(6,8,10,12)								

Released ratings, (ESR ratings in mOhms in parentheses)

Note: Voltage ratings are minimum values. AVX reserves the right to supply higher voltage ratings in the same case size, to the same reliability standards.

RATINGS & PART NUMBER REFERENCE

AVX Part No.	Case Size	Capacitance (µF)	Rated Voltage (V)	Maximum Operating Temperature (°C)	DCL Max. (µA)	DF Max. (%)	ESR Max. @ 100kHz (mΩ)	100kHz RMS Current (mA)			MSL
								45°C	85°C	125°C	
2.5 Volt @ 105°C											
TCME477M002#0010E	E	470	2.5	125	117.5	10	10	6400	4500	1600	3
TCME477M002#0012E	E	470	2.5	125	117.5	10	12	5800	4100	1500	3
TCME687M002#0010E	E	680	2.5	125	170	10	10	6400	4500	1600	3
TCME687M002#0012E	E	680	2.5	125	170	10	12	5800	4100	1500	3
TCME108M002#0006E	E	1000	2.5	125	250	10	6	8300	5800	2100	3
TCME108M002#0010E	E	1000	2.5	125	250	10	10	6400	4500	1600	3
TCME108M002#0012E	E	1000	2.5	125	250	10	12	5800	4100	1500	3
4 Volt @ 105°C											
TCME477M004#0010E	E	470	4	125	188	8	10	6400	4500	1600	3
TCME477M004#0012E	E	470	4	125	188	8	12	5800	4100	1500	3
TCME687M004#0010E	E	680	4	125	272	8	10	6400	4500	1600	3
TCME687M004#0012E	E	680	4	125	272	8	12	5800	4100	1500	3
TCME108M004#0006E	E	1000	4	125	400	8	6	8300	5800	2100	3
TCME108M004#0008E	E	1000	4	125	400	8	8	7200	5000	1800	3
TCME108M004#0010E	E	1000	4	125	400	8	10	6400	4500	1600	3
TCME108M004#0012E	E	1000	4	125	400	8	12	5800	4100	1500	3
6.3 Volt @ 105°C											
TCME337M006#0010E	E	330	6.3	125	198	8	10	6400	4500	1600	3
TCME337M006#0015E	E	330	6.3	125	198	8	15	5200	3600	1300	3
TCME477M006#0007E	E	470	6.3	125	282	10	7	7700	5400	1900	3
TCME477M006#0010E	E	470	6.3	125	282	10	10	6400	4500	1600	3
TCME477M006#0012E	E	470	6.3	125	282	10	12	5800	4100	1500	3
TCME687M006#0012E	E	680	6.3	125	408	8	12	5800	4100	1500	3
10 Volt @ 105°C											
TCME227M010#0025E	E	220	10	125	220	8	25	4000	2800	1000	3
TCME337M010#0010E	E	330	10	125	330	8	10	6400	4500	1600	3
TCME337M010#0015E	E	330	10	125	330	8	15	5200	3600	1300	3
TCME477M010#0015E	E	470	10	125	470	10	15	5200	3600	1300	3
TCME477M010#0025E	E	470	10	125	470	10	25	4000	2800	1000	3
16 Volt @ 105°C											
TCME107M016#0025E	E	100	16	125	160	8	25	4000	2800	1000	3
TCME157M016#0025E	E	150	16	125	240	8	25	4000	2800	1000	3
TCME157M016#0040E	E	150	16	125	240	8	40	3200	2200	800	3
TCME227M016#0025E	E	220	16	125	352	8	25	4000	2800	1000	3
TCME227M016#0040E	E	220	16	125	352	8	40	3200	2200	800	3
TCME337M016#0015E	E	330	16	125	528	8	15	5200	3600	1300	3
TCME337M016#0025E	E	330	16	125	528	8	25	4000	2800	1000	3
20 Volt @ 105°C											
TCME686M020#0025E	E	68	20	125	136	8	25	4000	2800	1000	3
TCME107M020#0025E	E	100	20	125	200	8	25	4000	2800	1000	3



The Important Information/Disclaimer is incorporated in the catalog where these specifications came from or available online at www.avx.com/disclaimer/ by reference and should be reviewed in full before placing any order.

AVX Part No.	Case Size	Capacitance (μF)	Rated Voltage (V)	Maximum Operating Temperature (°C)	DCL Max. (μA)	DF Max. (%)	ESR Max. @ 100kHz (mΩ)	100kHz RMS Current (mA)			MSL
								45°C	85°C	125°C	
25 Volt @ 105°C											
TCME336M025#0060E	E	33	25	125	82.5	8	60	2600	1800	700	3
TCME476M025#0060E	E	47	25	125	117.5	8	60	2600	1800	700	3
TCME686M025#0050E	E	68	25	125	170	8	50	2900	2000	700	3
35 Volt @ 105°C											
TCME226M035#0025E	E	22	35	125	77	8	25	4000	2800	1000	3
TCME336M035#0060E	E	33	35	125	115.5	8	60	2600	1800	700	3
TCME476M035#0045E	E	47	35	125	164.5	8	45	3000	2100	800	3
TCME476M035#0060E	E	47	35	125	164.5	8	60	2600	1800	700	3
50 Volt @ 105°C											
TCME156M050#0100E	E	15	50	125	75	10	100	2000	1400	500	3
TCME226M050#0075E	E	22	50	125	110	10	75	2300	1600	600	3
100 Volt @ 105°C											
TCMV106M100R/S0050E	V	10	100	125	100	8	50	2900	2000	700	3

Moisture Sensitivity Level (MSL) is defined according to J-STD-020. All technical data relates to an ambient temperature of +25°C. Capacitance and DF are measured at 120Hz, 0.5RMS with DC bias of 2.2 volts. DCL is measured at rated voltage after 5 minutes. ESR allowed to move up to 1.25 times catalog limit post mounting. For typical weight and composition see page 276. **NOTE: AVX reserves the right to supply higher voltage ratings or tighter tolerance part in the same case size, to the same reliability standards.**

RECOMMENDED DERATING FACTOR

Voltage and temperature derating as percentage of Vr.

Rated voltage	Operating Temperature		
	≤85°C	105°C	125°C
≤10V	90%	90%	60%
≥16V	80%	80%	54%

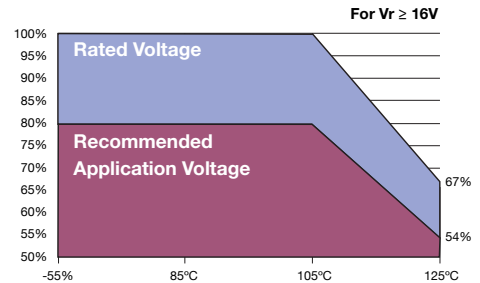
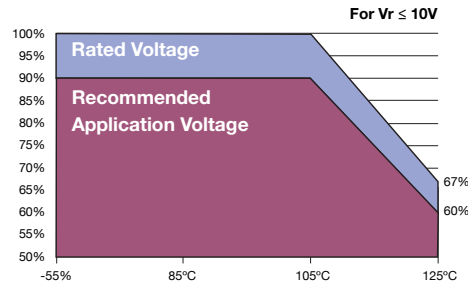

QUALIFICATION TABLE

TCM series (Temperature range -55°C to +125°C)											
TEST	Condition			Characteristics							
Endurance	Apply rated voltage (Ur) at 105°C and category voltage (Uc) at 125°C for 2000 hours through a circuit impedance of ≤0.1Ω/V. Stabilize at room temperature for 1-2 hours before measuring.			Visual examination	no visible damage						
				DCL	1.25 x initial limit						
				ΔC/C	within ±20% of initial value						
				DF	1.5 x initial limit						
				ESR	2 x initial limit						
Storage Life	Store at 125°C, no voltage applied, for 2000 hours. Stabilize at room temperature for 1-2 hours before measuring.			Visual examination	no visible damage						
				DCL	2 x initial limit						
				ΔC/C	within ±20% of initial value						
				DF	1.5 x initial limit						
				ESR	2 x initial limit						
Humidity	Store at 65°C and 95% relative humidity for 500 hours, with no applied voltage. Stabilize at room temperature and humidity for 1-2 hours before measuring.			Visual examination	no visible damage						
				DCL	3 x initial limit						
				ΔC/C	within +30/-20% of initial value						
				DF	1.5 x initial limit						
				ESR	2 x initial limit						
Temperature Stability	Step	Temperature°C	Duration(min)								
	1	+20	15								
	2	-55	15	DCL	IL*	n/a	IL*	10 x IL*	12.5 x IL*	IL*	
	3	+20	15	ΔC/C	n/a	+0/-20%	±10%	+20/-0%	+30/-0%	±10%	
	4	+85	15	DF	IL*	1.5 x IL*	IL*	1.5 x IL*	2 x IL*	IL*	
	5	+125	15								
6	+20	15									
Surge Voltage	Apply 1.3x category voltage (Uc) at 125°C for 1000 cycles of duration 6 min (30 sec charge, 5 min 30 sec discharge) through a charge/discharge resistance of 1000Ω			Visual examination	no visible damage						
				DCL	initial limit						
				ΔC/C	within +20/-30% of initial value						
				DF	1.25 x initial limit						

*Initial Limit

Initial measurement max. 1hr after the removal from dry pack or after pretreatment at 85°C for 24 hours.

SOLID ELECTROLYTIC CAPACITOR ROADMAP

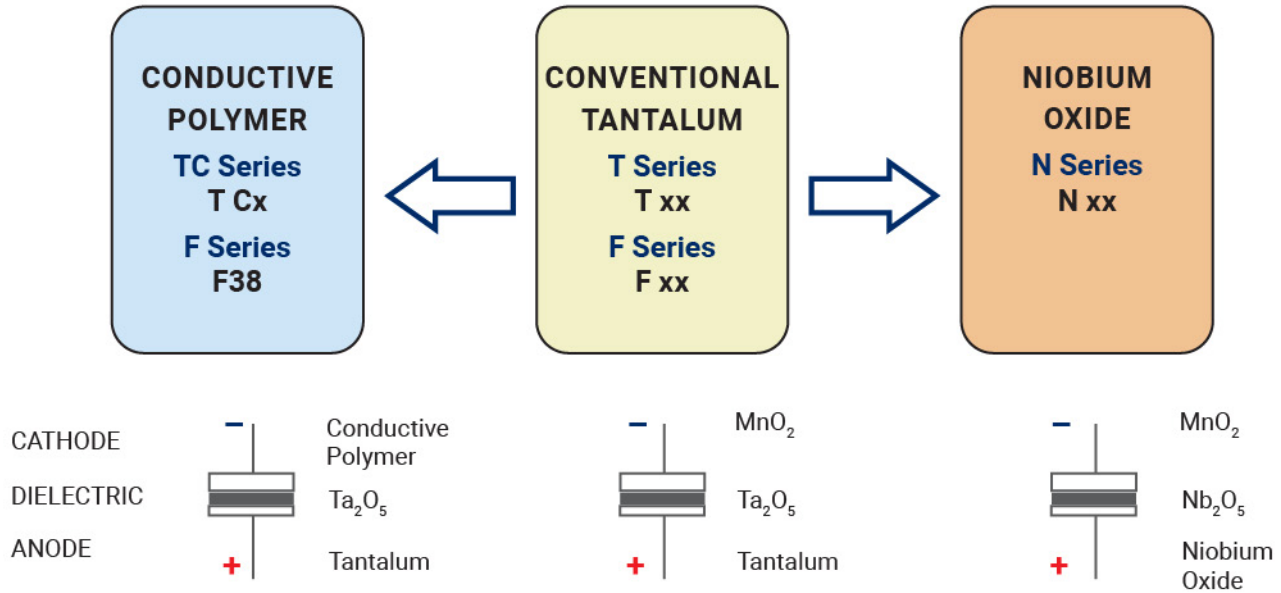

FIVE CAPACITOR CONSTRUCTION STYLES

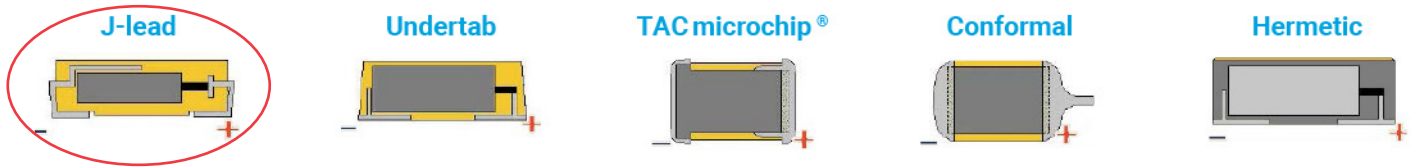

SERIES LINE UP : Conductive Polymer

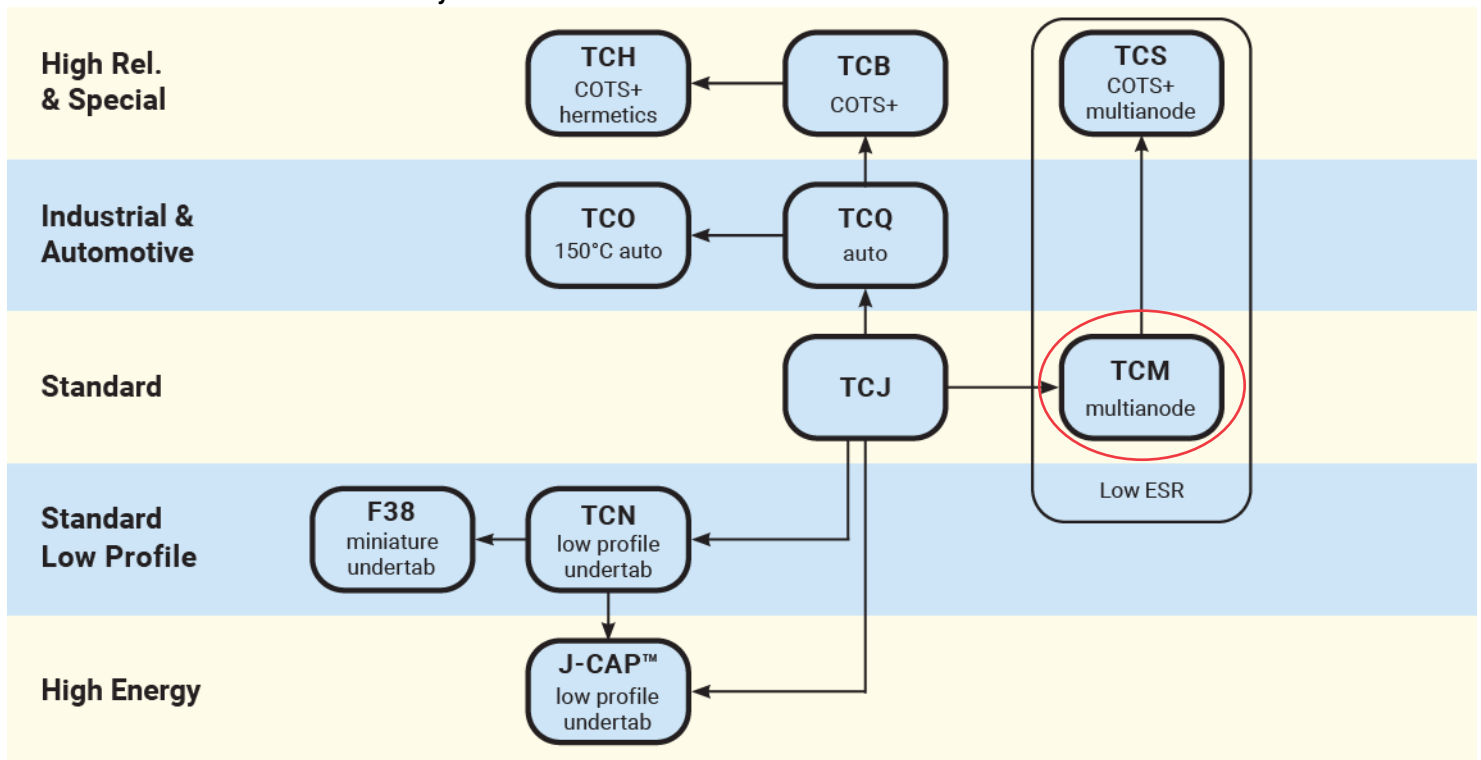

TCN Series

Highest CV/CC Conductive Polymer Chip Capacitors Undertab

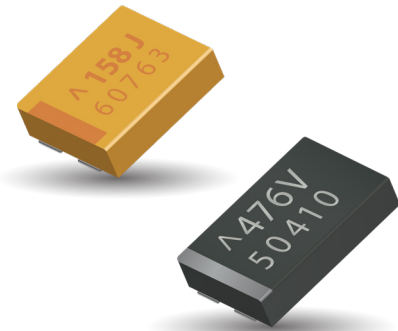

FEATURES

- Highest CV/cc in Broad Range of Low Profiles
- Conductive Polymer Electrode
- Benign Failure Mode Under Recommended Use Conditions
- Lower ESR
- Undertab Terminations Layout:
 - High Volumetric Efficiency
 - High PCB Assembly Density
 - High Capacitance in Smaller Dimensions
- 3x Reflow 260°C Compatible
- 100% Surge Current Tested
- 12 Case Sizes Available



LEAD-FREE
LEAD-FREE COMPATIBLE
COMPONENT



APPLICATIONS

- Consumer Applications (e.g. Mobiles, MP3 etc.)
- Bulk Decoupling of SoC (System on Chip)

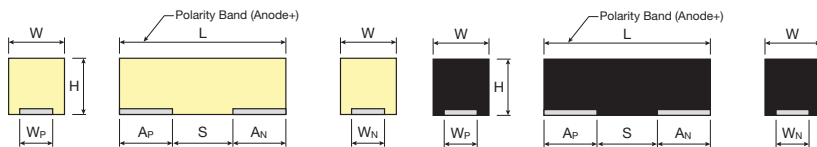

CASE DIMENSIONS:

millimeters (inches)

Code	EIA Code	EIA Metric	L±0.20 (0.008)	W+0.20 (0.008) -0.10 (0.004)	H max.	Wp±0.10 (0.004)	Wn±0.10 (0.004)	Ap±0.10 (0.004)	An±0.10 (0.004)	S Min.
M	0805	2012-09	2.05 (0.081)	1.30 (0.051)	0.90 (0.035)	1.00 (0.039)	1.00 (0.039)	0.85 (0.033)	0.85 (0.033)	0.40 (0.016)
N	0805	2012-10	2.05 (0.081)	1.30 (0.051)	1.00 (0.039)	1.00 (0.039)	1.00 (0.039)	0.85 (0.033)	0.85 (0.033)	0.40 (0.016)
O	1206	3216-06	3.20 (0.126)	1.60 (0.063)	0.60 (0.024)	1.30 (0.051)	1.30 (0.051)	1.15 (0.045)	1.15 (0.045)	0.90 (0.035)
K	1206	3216-10	3.20 (0.126)	1.60 (0.063)	1.00 (0.039)	1.30 (0.051)	1.30 (0.051)	1.15 (0.045)	1.15 (0.045)	0.90 (0.035)
S	1206	3216-12	3.20 (0.126)	1.60 (0.063)	1.20 (0.047)	1.30 (0.051)	1.30 (0.051)	1.15 (0.045)	1.15 (0.045)	0.90 (0.035)
L	1210	3528-10	3.50 (0.138)	2.80 (0.110)	1.00 (0.039)	2.50 (0.098)	2.10 (0.083)	1.15 (0.045)	1.35 (0.053)	1.00 (0.039)
T	1210	3528-12	3.50 (0.138)	2.80 (0.110)	1.20 (0.047)	2.50 (0.098)	2.10 (0.083)	1.15 (0.045)	1.35 (0.053)	1.00 (0.039)
H	1210	3528-15	3.50 (0.138)	2.80 (0.110)	1.50 (0.059)	2.50 (0.098)	2.10 (0.083)	1.15 (0.045)	1.35 (0.053)	1.00 (0.039)
X	2917	7343-15	7.30 (0.287)	4.30 (0.169)	1.50 (0.059)	3.25 (0.128)	3.25 (0.128)	2.00 (0.079)	3.20 (0.126)	2.10 (0.083)
Z	2917	7343-15	7.30 ±0.30 (0.287 ±0.012)	4.30 ±0.30 (0.169 ±0.012)	1.50 (0.059)	2.40 (0.094)	2.40 (0.094)	1.30 ±0.30 (0.051 ±0.012)	1.30 ±0.30 (0.051 ±0.012)	4.40 (0.173)
4	2924	7361-20	7.30 (0.287)	6.10 (0.240)	2.00 (0.079)	4.75 (0.187)	4.75 (0.187)	2.00 (0.079)	3.20 (0.126)	2.10 (0.083)
8	2924	7361-20	7.30 ±0.30 (0.287 ±0.012)	6.10 (0.240)	2.00 (0.079)	4.45 (0.175)	4.45 (0.175)	1.60 ±0.30 (0.063 ±0.012)	1.60 ±0.30 (0.063 ±0.012)	3.80 (0.150)

MARKING

H, K, L, O, S, T, X, Z CASE

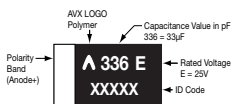
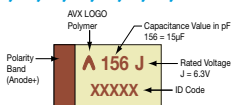

M, N CASE

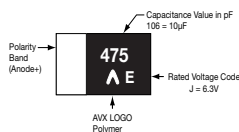
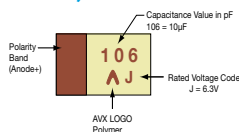

4, 8 CASE

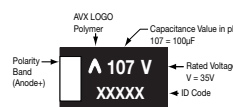
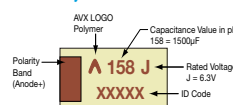

HOW TO ORDER

TCN

Type

L

Case Size
See table above

157

Capacitance Code
pF code: 1st two digits represent significant figures, 3rd digit represents multiplier (number of zeros to follow)

M

Tolerance
M = ±20%

006

Rated DC Voltage
006 = 6.3Vdc
016 = 16Vdc
020 = 20Vdc
025 = 25Vdc
035 = 35Vdc

R

Packaging
R = Pure Tin 7" Reel
S = Pure Tin 13" Reel

0200

ESR in mΩ

E

Additional Character
E = Black resin

Part Numbers already changed to an "E" suffix will continue to be supplied with only black resin. Those Part Numbers currently produced with gold resin will eventually change to black before July, 2020.

TECHNICAL SPECIFICATIONS

Technical Data:		All technical data relate to an ambient temperature of +25°C								
Capacitance Range:		1.0 μF to 1500 μF								
Capacitance Tolerance:		±20%								
Leakage Current DCL:		0.1CV								
Rated Voltage DC (V _R)	≤ +85°C:	4	6.3	10	16	20	25	35	50	
Category Voltage (V _C)	≤ +105°C:	3.2	5	8	13	16	20	28	40	
Surge Voltage (V _S)	≤ +85°C:	5.2	8	13	21	26	33	46	65	
Surge Voltage (V _S)	≤ +105°C:	4	6	10	16	20	25	35	50	
Temperature Range:		-55°C to +105°C								

NOTE: Conductive Polymer Capacitors are designed to operate within the limits of the environmental conditions specified for each series. If operated continuously at their maximum temperature and / or humidity limit, or beyond these limits, capacitors may exhibit a parametric shift in capacitance and increases in ESR. These changes may occur earlier if the specified environmental conditions are exceeded. Similarly, their normal operational time period will be significantly extended if their general duty cycle includes operation below maximum temperature within humidity controlled environments. Careful attention should be paid to maximum temperature with associated high humidity environments as well as voltage derating, ripple current and current surges. Please reference the AVX Conductive Polymer Capacitor Guidelines for more information or contact factory for application assistance.

CAPACITANCE AND RATED VOLTAGE RANGE (LETTER DENOTES CASE SIZE)

Capacitance		Rated Voltage DC to 85°C / 0.66DC to 105°C							
μF	Code	4V (G)	6.3V (J)	10V (A)	16V (C)	20V (D)	25V (E)	35V (V)	50V (T)
1.0	105								N(1500)
4.7	475						N(500)	L(300)/T(200)	
6.8	685				O(500)				
10	106			O(500)	O(500)		K(350)/S(350)	T(150, 200)	
15	156		O(500)	O(500)					
22	226	O(500)	O(500)				T(200)		
33	336				L(200)/T(200)		T(250)		4(200)
47	476		M(500)		L(250)/T(150)		X(100)	X(150)/Z(150)	
68	686								
100	107		K(200,250) L(200)/S(250)				3(70)*/4(100)	3(200)*/4(100) 8(100)	
150	157		L(200) S(250)/T(200)		X(100)		4(70)/8(70)		
220	227		H(170)/T(200)		4(70)	4(100)	4(100)		
330	337				4(70)	4(100)			
470	477		X(50)		4(70,100)				
680	687			4(70)					
1000	108		X(200) 3(100)*/4(55)						
1500	158		4(55)						

Released ratings, (ESR ratings in mOhms in parentheses)

*Codes under development - subject to change

Engineering Samples - Please Contact AVX

Note: Voltage ratings are minimum values. AVX reserves the right to supply

higher voltage ratings in the same case size, to the same reliability standards.

TCN Series

Highest CV/CC Conductive Polymer Chip Capacitors Undertab



RATINGS & PART NUMBER REFERENCE

AVX Part No.	Case Size	Capacitance (µF)	Rated Voltage (V)	Maximum Operating Temperature (°C)	DCL Max. (µA)	DF Max. (%)	ESR Max. @ 100kHz (mΩ)	100kHz RMS Current (mA)			Product Category	MSL
								45°C	85°C	105°C		
4 Volt @ 85°C												
TCNO226M004#0500E	O	22	4	105	8.8	10	500	400	300	200	3	3
6.3 Volt @ 85°C												
TCNO156M006#0500E	O	15	6.3	105	9	10	500	400	300	200	3	3
TCNO226M006#0500E	O	22	6.3	105	13.2	10	500	400	300	200	3	3
TCNM476M006#0500E	M	47	6.3	105	28.2	10	500	400	300	200	3	3
TCNK107M006#0200E	K	100	6.3	105	60	10	200	700	500	300	3	5
TCNK107M006#0250E	K	100	6.3	105	60	10	250	600	400	300	3	5
TCNL107M006#0200E	L	100	6.3	105	60	10	200	700	500	300	3	5
TCNS107M006#0250E	S	100	6.3	105	60	10	250	600	400	300	3	3
TCNL157M006#0200E	L	150	6.3	105	90	10	200	700	500	300	3	5
TCNS157M006#0250E	S	150	6.3	85	90	10	250	600	400	-	5	3
TCNT157M006#0200E	T	150	6.3	105	90	10	200	700	500	300	3	4
TCNH227M006#0170E	H	220	6.3	105	132	10	170	800	600	400	3	4
TCNT227M006#0200E	T	220	6.3	85	132	10	200	700	500	-	5	4
TCNX477M006#0050E	X	470	6.3	85	282	10	50	1900	1300	-	5	5
TCNX108M006#0200E	X	1000	6.3	85	600	30	200	900	600	-	5	5
TCN3108M006#0100	3	1000	6.3	105	600	20	100	1200	840	480	3	5
TCN4108M006#0025E	4	1000	6.3	85	600	20	55	1860	1302	-	5	4
TCN4158M006#0055E	4	1500	6.3	85	900	20	55	1860	1302	-	5	4
10 Volt @ 85°C												
TCNO106M010#0500E	O	10	10	105	10	10	500	400	300	200	3	3
TCNO156M010#0500E	O	15	10	105	15	10	500	400	300	200	3	3
TCN4687M010#0070E	4	680	10	105	680	20	70	1650	1155	660	3	4
16 Volt @ 85°C												
TCNO685M016#0500E	O	6.8	16	105	10.9	10	500	400	300	200	3	3
TCNO106M016#0500E	O	10	16	105	16	10	500	400	300	200	3	3
TCNL336M016#0200E	L	33	16	85	52.8	6	200	700	500	-	5	5
TCNT336M016#0200E	T	33	16	105	52.8	6	200	700	500	300	3	4
TCNL476M016#0250E	L	47	16	85	75.2	6	250	600	400	-	5	5
TCNT476M016#0150E	T	47	16	105	75.2	6	150	800	600	400	3	4
TCNX157M016#0100E	X	150	16	105	240	6	100	1300	900	600	3	4
TCN4227M016#0070E	4	220	16	105	352	20	70	1650	1155	660	2	4
TCN4337M016#0070E	4	330	16	105	528	20	70	1650	1155	660	3	4
TCN4477M016#0070E	4	470	16	105	752	20	70	1650	1155	660	3	4
TCN4477M016#0100E	4	470	16	85	752	20	100	1380	966	-	5	4
20 Volt @ 85°C												
TCN4227M020#0100E	4	220	20	85	440	10	100	1380	966	-	5	4
TCN4337M020#0100E	4	330	20	105	660	20	100	1380	966	552	3	4
25 Volt @ 85°C												
TCNN475M025#0500E	N	4.7	25	105	11.8	10	500	400	300	200	3	3
TCNK106M025#0350E	K	10	25	105	25	10	350	500	400	200	3	5
TCNS106M025#0350E	S	10	25	105	25	10	350	500	400	200	3	5
TCNT226M025#0200E	T	22	25	105	55	6	200	700	500	300	3	4
TCNT336M025#0250E	T	33	25	105	82.5	10	250	600	400	300	3	4
TCNX476M025#0100E	X	47	25	105	117.5	6	100	1300	900	600	2	5
TCN3107M025#0070	3	100	25	105	250	6	70	1440	1008	576	2	5
TCN4107M025#0100E	4	100	25	105	250	6	100	1380	966	552	2	4
TCN4157M025#0070E	4	150	25	105	375	6	70	1650	1155	660	2	4
TCN8157M025#0070E	8	150	25	105	375	8	70	1650	1155	660	2	3
TCN4227M025#0100E	4	220	25	105	550	10	100	1380	966	552	3	4
35 Volt @ 85°C												
TCNL475M035#0300E	L	4.7	35	105	16.5	6	300	600	400	300	2	5
TCNT475M035#0200E	T	4.7	35	105	16.5	10	200	700	500	300	3	4
TCNT106M035#0150E	T	10	35	105	35	10	150	800	600	400	3	4
TCNT106M035#0200E	T	10	35	105	35	10	200	700	500	300	3	4
TCNX476M035#0150E	X	47	35	105	165	10	150	1100	800	500	3	4
TCNZ476M035#0150E	Z	47	35	105	165	10	150	1100	800	500	3	4
TCN3107M035#0200	3	100	35	85	350	10	200	850	595	-	5	5
TCN4107M035#0100E	4	100	35	105	350	10	100	1380	966	552	2	3
TCN8107M035#0100E	8	100	35	105	350	10	100	1380	966	552	2	3
50 Volt @ 85°C												
TCNN105M050#1500E	N	1	50	105	5	10	1500	200	100	100	3	3
TCN4336M050#0200E	4	33	50	85	165	12	200	970	679	-	5	3

Moisture Sensitivity Level (MSL) is defined according to J-STD-020.

All technical data relates to an ambient temperature of +25°C. Capacitance and DF are measured at 120Hz, 0.5RMS with DC bias of 2.2 volts. DCL is measured at rated voltage after 5 minutes.

ESR allowed to move up to 1.25 times catalog limit post mounting.

For typical weight and composition see page 276.

NOTE: AVX reserves the right to supply higher voltage ratings in the same case size to the same reliability standards.

RECOMMENDED DERATING FACTOR

Voltage and temperature derating as percentage of Vr

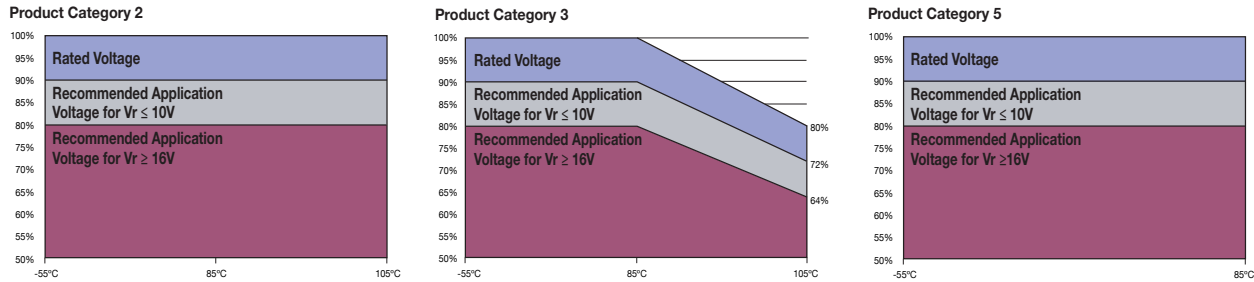

PRODUCT CATEGORY 2, 3 (TEMPERATURE RANGE -55°C TO +105°C)

TEST	Condition	Characteristics								
Endurance	Apply rated voltage (U_r) at 85°C for 2000 hours through a circuit impedance of $\leq 0.1\Omega/V$ (all CATEGORIES). And / or apply rated voltage (U_r) (CATEGORY 2) or 0.8x rated voltage (CATEGORY 3) at 105°C for 2000 hours through a circuit impedance of $\leq 0.1\Omega/V$. Always stabilize at room temperature for 1-2 hours before measuring.	Visual examination	no visible damage							
		DCL	1.25 x initial limit							
		$\Delta C/C$	within $\pm 20\%$ of initial value							
		DF	1.5 x initial limit							
		ESR	2 x initial limit							
Storage Life	Store at 105°C, no voltage applied, for 2000 hours. Stabilize at room temperature for 1-2 hours before measuring.	Visual examination	no visible damage							
		DCL ($V_r \leq 75V$)	1.25 x initial limit							
		DCL ($V_r > 75V$)	2 x initial limit							
		$\Delta C/C$	within $\pm 20\%$ of initial value							
		DF	1.5 x initial limit							
Humidity	Store at 65°C and 95% relative humidity for 500 hours, with no applied voltage. Stabilize at room temperature and humidity for 1-2 hours before measuring.	Visual examination	no visible damage							
		DCL	3 x initial limit							
		$\Delta C/C$	within +30/-20% of initial value							
		DF	1.5 x initial limit							
		ESR	2 x initial limit							
Temperature Stability	Step	Temperature(°C)	Duration(min)							
	1	+20	15		+20°C	-55°C	+20°C	+85°C	+105°C	+20°C
	2	-55	15	DCL	IL*	n/a	IL*	10 x IL*	12.5 x IL*	IL*
	3	+20	15	$\Delta C/C$	n/a	+0/-20%	$\pm 5\%$	+20/-0%	+30/-0%	$\pm 5\%$
	4	+85	15	DF	IL*	1.5 x IL*	IL*	1.5 x IL*	2 x IL*	IL*
	5	+105	15							
6	+20	15								
Surge Voltage	Apply 1.3x rated voltage (U_r) at 105°C for CATEGORY 2, or apply 1.3x 0.8x rated voltage (U_r) at 105°C for CATEGORY 3 for 1000 cycles of duration 6 min (30 sec charge, 5 min 30 sec discharge) through a charge / discharge resistance of 1000 Ω	Visual examination	no visible damage							
		DCL	initial limit							
		$\Delta C/C$	within +10/-20% of initial value for $V_r \leq 10V$ within +20/-30% of initial value for $V_r \geq 16V$							
		DF	1.25 x initial limit							
Mechanical Shock	MIL-STD-202, Method 213, Condition C	Visual examination	no visible damage							
		DCL	initial limit							
		$\Delta C/C$	within $\pm 5\%$ of initial value							
		DF	initial limit							
Vibration	MIL-STD-202, Method 204, Condition D	Visual examination	no visible damage							
		DCL	initial limit							
		$\Delta C/C$	within $\pm 5\%$ of initial value							
		DF	initial limit							

*Initial Limit

Initial measurement max. 1hr after the removal from dry pack or after pretreatment at 85°C for 24 hours.

TCN Series

Highest CV/CC Conductive Polymer Chip Capacitors Undertab



PRODUCT CATEGORY 5 (TEMPERATURE RANGE -55°C TO +85°C)

TEST	Condition			Characteristics								
Endurance	Apply rated voltage (Ur) at 85°C for 2000 hours through a circuit impedance of $\leq 0.1\Omega/V$. Stabilize at room temperature for 1-2 hours before measuring.			Visual examination	no visible damage							
				DCL	1.25 x initial limit							
				$\Delta C/C$	within $\pm 20\%$ of initial value							
				DF	1.5 x initial limit							
				ESR	2 x initial limit							
Storage Life	Store at 85°C, no voltage applied, for 2000 hours. Stabilize at room temperature for 1-2 hours before measuring.			Visual examination	no visible damage							
				DCL	1.25 x initial limit							
				$\Delta C/C$	within $\pm 20\%$ of initial value							
				DF	1.5 x initial limit							
				ESR	2 x initial limit							
Humidity	Store at 65°C and 95% relative humidity for 500 hours, with no applied voltage. Stabilize at room temperature and humidity for 1-2 hours before measuring.			Visual examination	no visible damage							
				DCL	5 x initial limit							
				$\Delta C/C$	within +40/-20% of initial value							
				DF	1.5 x initial limit							
				ESR	2 x initial limit							
Temperature Stability	Step	Temperature°C	Duration(min)									
	1	+20	15									
	2	-55	15	DCL	IL*	n/a	IL*	+20°C	+85°C	+20°C	10 x IL*	IL*
	3	+20	15	$\Delta C/C$	n/a	+0/-20%	$\pm 5\%$	+20/-0%	$\pm 5\%$			
	4	+85	15	DF	IL*	1.5 x IL*	IL*	1.5 x IL*	IL*			
	5	+20	15									
Surge Voltage	Apply 1.3x rated voltage (Ur) at 85°C for 1000 cycles of duration 6 min (30 sec charge, 5 min 30 sec discharge) through a charge / discharge resistance of 1000 Ω .			Visual examination	no visible damage							
				DCL	initial limit							
				$\Delta C/C$	within +10/-20% of initial value for Vr $\leq 10V$ within +20/-30% of initial value for Vr $\geq 16V$							
				DF	1.25 x initial limit							
Mechanical Shock	MIL-STD-202, Method 213, Condition C			Visual examination	no visible damage							
				DCL	initial limit							
				$\Delta C/C$	within $\pm 5\%$ of initial value							
				DF	initial limit							
				ESR	initial limit							
Vibration	MIL-STD-202, Method 204, Condition D			Visual examination	no visible damage							
				DCL	initial limit							
				$\Delta C/C$	within $\pm 5\%$ of initial value							
				DF	initial limit							
				ESR	initial limit							

*Initial Limit

Initial measurement max. 1hr after the removal from dry pack or after pretreatment at 85°C for 24 hours.

TCN Series

Highest CV/CC Conductive Polymer Chip Capacitors Undertab

SOLID ELECTROLYTIC CAPACITOR ROADMAP

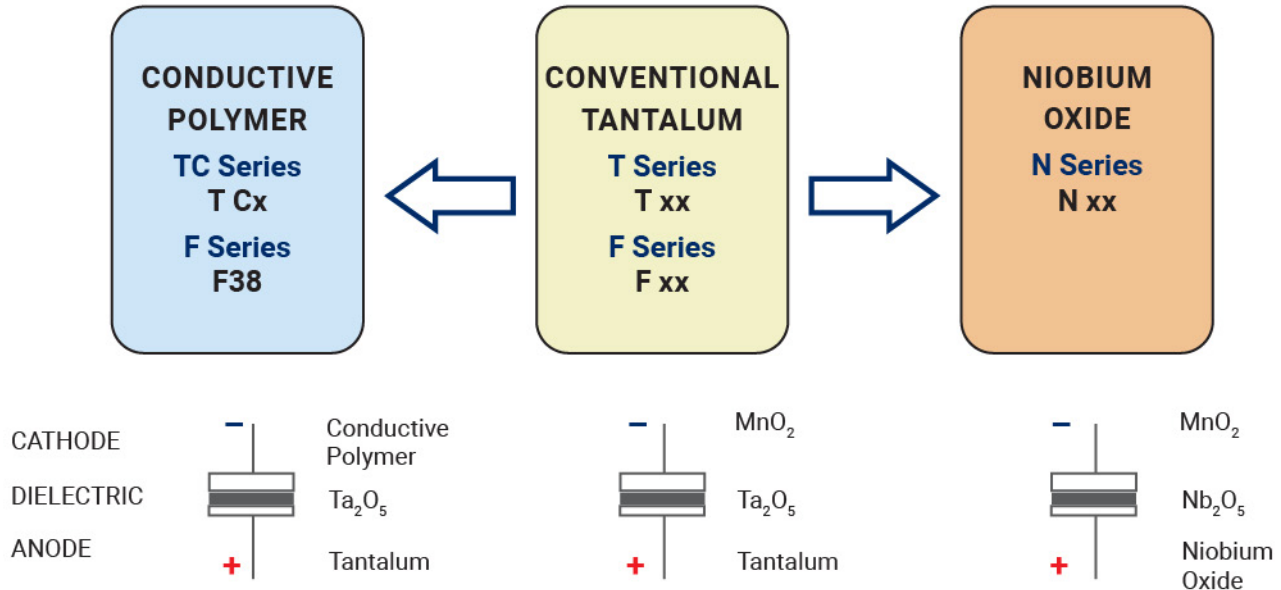

FIVE CAPACITOR CONSTRUCTION STYLES

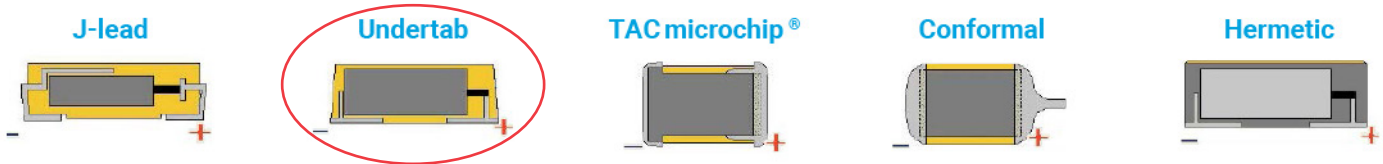

SERIES LINE UP : Conductive Polymer

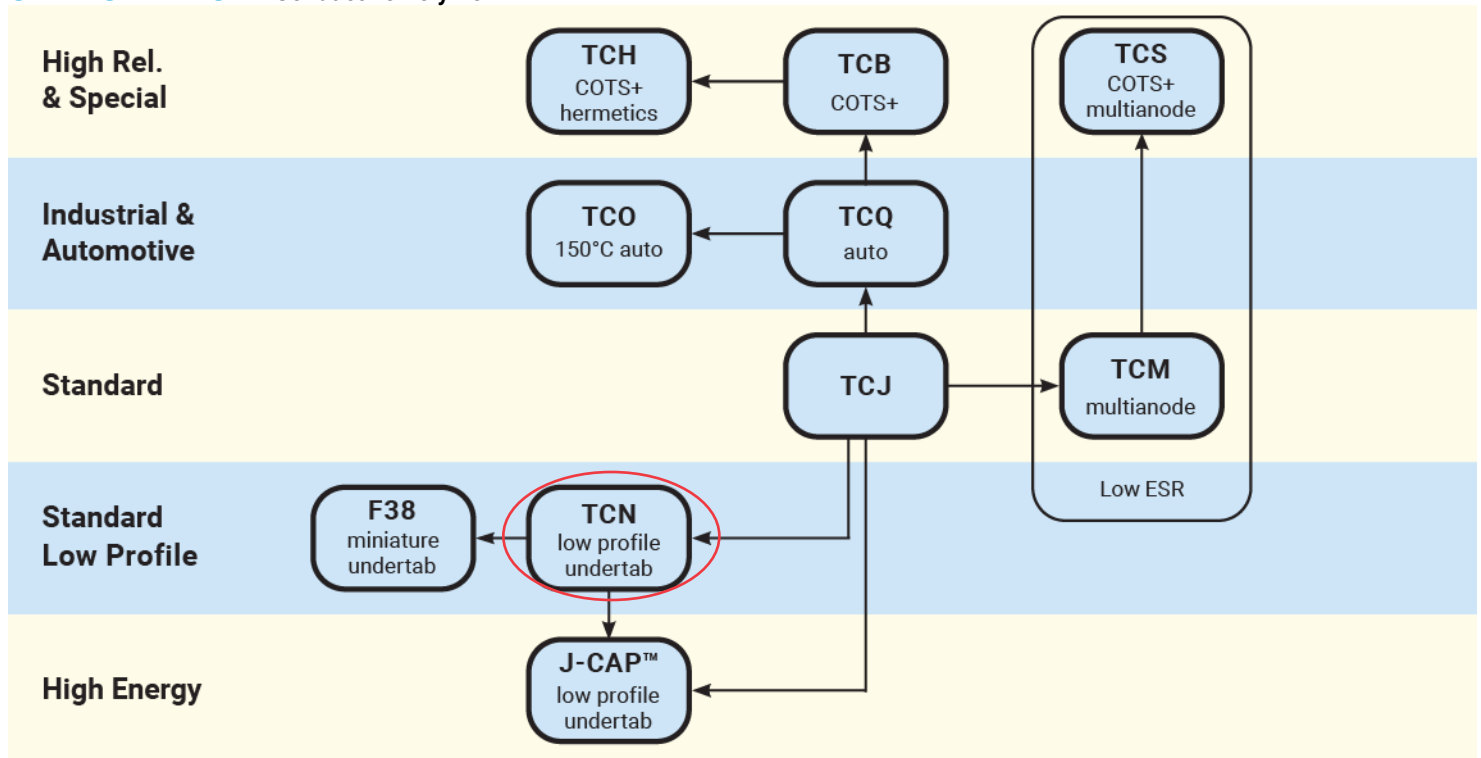

J-CAP™ Series

Highest Joules/cc Conductive Polymer Solid Electrolytic Chip Capacitors



FEATURES

- Highest Energy per Volume
- Fast DCL Drop With Voltage Applied After Reflow
- Benign Failure Mode Under Recommended Use Conditions
- Low ESR
- Undertab Terminations Layout:
 - High Volumetric Efficiency
 - Low Profile Case Sizes
 - High Capacitance in Smaller Dimensions
 - Close Positioning of Several Parts for Efficient High Density PCB Layout
- 3x Reflow 260°C Compatible
- 100% Surge Current Tested



APPLICATIONS

- Power Backup for SSDs (MLC, SLC, EFD, PCIe), Battery-Powered Portable Equipment, Industrial Alarms, Smart Power Meters, and Mobile Devices

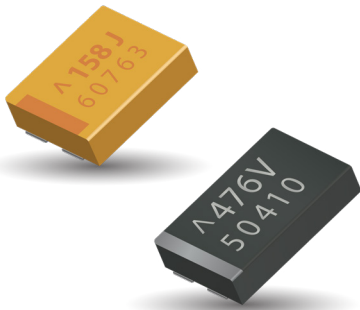

J-LEAD

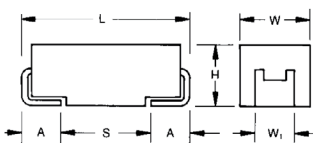

UNDERTAB

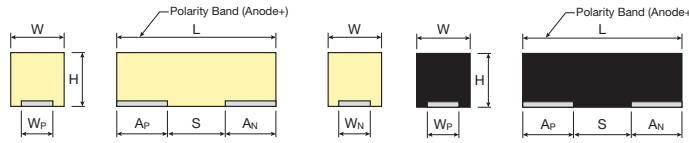

CASE DIMENSIONS UNDERTAB:

millimeters (inches)

Code	EIA Code	EIA Metric	L±0.20 (0.008)	W+0.20 (0.008) -0.10 (0.004)	H max.	Wp±0.10 (0.004)	Wn±0.10 (0.004)	Ap±0.10 (0.004)	An±0.10 (0.004)	S Min.
L	1210	3528-10	3.50 (0.138)	2.80 (0.110)	1.00 (0.039)	2.50 (0.098)	2.10 (0.083)	1.15 (0.045)	1.35 (0.053)	1.00 (0.039)
T	1210	3528-12	3.50 (0.138)	2.80 (0.110)	1.20 (0.047)	2.50 (0.098)	2.10 (0.083)	1.15 (0.045)	1.35 (0.053)	1.00 (0.039)
X	2917	7343-15	7.30 (0.287)	4.30 (0.169)	1.50 (0.059)	3.25 (0.128)	3.25 (0.128)	2.00 (0.079)	3.20 (0.126)	2.10 (0.083)
Z	2917	7343-15	7.30±0.30 (0.287±0.012)	4.30±0.30 (0.169±0.012)	1.50 (0.059)	2.40 (0.094)	2.40 (0.094)	1.30±0.30 (0.051±0.012)	1.30±0.30 (0.051±0.012)	4.40 (0.173)
4	2924	7361-20	7.30 (0.287)	6.10 (0.240)	2.00 (0.079)	4.75 (0.187)	4.75 (0.187)	2.00 (0.079)	3.20 (0.126)	2.10 (0.083)
8	2924	7361-20	7.30±0.30 (0.287±0.012)	6.10 (0.240)	2.00 (0.079)	4.45 (0.175)	4.45 (0.175)	1.60±0.30 (0.063±0.012)	1.60±0.30 (0.063±0.012)	3.80 (0.150)

CASE DIMENSIONS J-LEAD:

millimeters (inches)

Code	EIA Code	EIA Metric	L±0.20 (0.008)	W+0.20 (0.008) -0.10 (0.004)	H±0.20 (0.008) -0.10 (0.004)	Wp±0.20 (0.008)	A±0.30 (0.012) -0.20 (0.008)	S Min.
C	2312	6032-28	6.00 (0.236)	3.20 (0.126)	2.60 (0.102)	2.20 (0.087)	1.30 (0.051)	2.90 (0.114)
D	2917	7343-31	7.30 (0.287)	4.30 (0.169)	2.90 (0.114)	2.40 (0.094)	1.30 (0.051)	4.40 (0.173)
E	2917	7343-43	7.30 (0.287)	4.30 (0.169)	4.10 (0.162)	2.40 (0.094)	1.30 (0.051)	4.40 (0.173)
H	1210	3528-15	3.50 (0.138)	2.80 (0.110)	1.50 (0.059) max.	2.20 (0.087)	0.80 (0.031)	1.40 (0.055)
5	2917	7343-40	7.30 (0.287)	4.30 (0.169)	3.80 (0.150)	2.40 (0.094)	1.30 (0.051)	4.40 (0.173)

W1 dimension applies to the termination width for A dimensional area only.

MAXIMUM ENERGY PER CASE SIZE

Case Size	H Max (mm)	Max Energy (mJ)
C	2.8	5.8
D	3.1	21.8
E	4.3	11.9
H	1.5	3.3
L	1.0	1.8
T	1.2	6.5
X	1.5	18.2
Z	1.5	18.2
4	2.0	43.0
5	4.0	46.6
8	2.0	38.8

MARKING

C, D, E, H, L, T, X, Z, 5 CASE

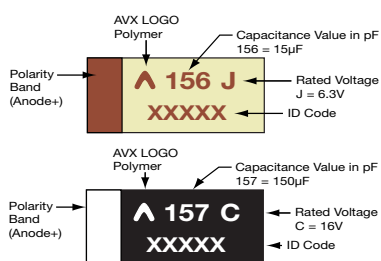

4, 8 CASE

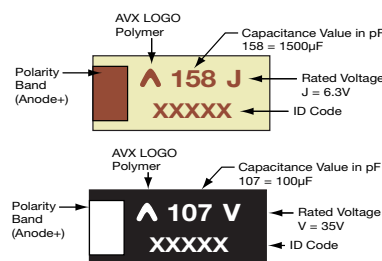

HOW TO ORDER

TCN

Type
TCJ
TCN

4

Case Size
See table above

158

Capacitance Code
pF code: 1st two digits represent significant figures, 3rd digit represents multiplier

M

Tolerance
M = ±20%

006

Rated DC Voltage
006 = 6.3Vdc 020 = 20Vdc
010 = 10Vdc 025 = 25Vdc
016 = 16Vdc 035 = 35Vdc

R

Packaging
R = Pure Tin 7" Reel
S = Pure Tin 13" Reel (J-Lead)

0055

ESR in mΩ

E

Additional Character
E = Black resin

Part Numbers already changed to an "E" suffix will continue to be supplied with only black resin. Those Part Numbers currently produced with gold resin will eventually change to black before July, 2020.



J-CAP™ Series

Highest Joules/cc Conductive Polymer Solid Electrolytic Chip Capacitors



TECHNICAL SPECIFICATIONS

Technical Data:	All technical data relate to an ambient temperature of +25°C							
Capacitance Range:	4.7 μF to 1500 μF							
Capacitance Tolerance:	±20%							
Leakage Current DCL:	0.1CV							
Rated Voltage DC (V _R)	≤ +85°C:	6.3	10	16	20	25	35	50
Surge Voltage (V _S)	≤ +85°C:	8	13	21	26	33	46	65
Temperature Range:	-55°C up to +125°C							

NOTE: Conductive Polymer Capacitors are designed to operate within the limits of the environmental conditions specified for each series. If operated continuously at their maximum temperature and / or humidity limit, or beyond these limits, capacitors may exhibit a parametric shift in capacitance and increases in ESR. These changes may occur earlier if the specified environmental conditions are exceeded. Similarly, their normal operational time period will be significantly extended if their general duty cycle includes operation below maximum temperature within humidity controlled environments. Careful attention should be paid to maximum temperature with associated high humidity environments as well as voltage derating, ripple current and current surges. Please reference the AVX Conductive Polymer Capacitor Guidelines for more information or contact factory for application assistance.

CAPACITANCE AND RATED VOLTAGE RANGE (LETTER DENOTES CASE SIZE)

Capacitance		Rated Voltage DC to 85°C, [mJ]							
μF	Code	6.3V (J)	10V (A)	16V (C)	20V (D)	25V (E)	35V (V)	50V (T)	
4.7	475						L(300) T(200) [1.8]		
6.8	685							C(200) [5.4]	
10	106						T(150,200) [3.9]	D(120) [8.0]	
15	156						C(200) [5.8]	E(70) [11.9]	
22	226					T(200) [4.3]	D(100) [8.5]		
33	336			H(150) T(200) [3.3]		T(250) [6.5]	D(70) [12.8]		
47	476		C(100) H(100) [1.7]	T(150) [4.7]		X(100) [9.2]	X(150)/ Z(150) [18.2]		
68	686	H(100) [0.8]	D(45) [2.5]	D(50) [6.7]	D(55) [8.4]	D(70) [13.3]			
100	107		D(45) [3.6]	D(50) [9.9]	D(55) [12.4]	D(70) 4(100) [19.6]	4(100)/ 8(100) [38.8]		
150	157	T(200) [1.7]	D(45) [5.4]	X(100) [14.9]		4(70)/ 8(70) [29.3]			
220	227	H(170) [2.6]	D(40) [7.9]	D(50) 4(70) [21.8]	4(100) [27.2]	4(100) [43.0]			
330	337	D(40) [3.8]	5(100) [11.9]	4(70) 5(100) [32.7]					
470	477	X(50) [5.4]		4(70,100) 5(100) [46.6]					
680	687		4(70) [24.5]						
1000	108	4(55) [11.6]							
1500	158	4(55) [17.4]							

Released ratings, (ESR ratings in mOhms in parentheses) [Energy in mJ]

Engineering Samples - Please Contact AVX

Note: Voltage ratings are minimum values. AVX reserves the right to supply higher voltage ratings in the same case size, to the same reliability standards.

RATINGS & PART NUMBER REFERENCE

AVX Part No.	Case Size	Capacitance (µF)	Rated Voltage (V)	Maximum Operating Temperature (°C)	DCL Max. (µA)	DF Max. (%)	ESR Max. @ 100kHz (mΩ)	1000kHz RMS Current (mA) 45°C	Product Category	MSL	ENERGY		
											Energy (mJ)	Energy/volume (mJ/cm³)	Energy/area (mJ/cm²)
6.3 Volt @ 85°C													
TCJH686M006#0100E	H	68	6.3	105	40.8	6	100	1000	3	3	0.8	54	8.0
TCNT157M006#0200E	T	150	6.3	105	90	10	200	700	3	4	1.7	147	17.7
TCJH227M006#0170E	H	220	6.3	105	132	10	170	800	3	3	2.6	173	26
TCJD337M006#0040E	D	330	6.3	105	198	6	40	2400	2	3	3.8	42	12.2
TCNX477M006#0050E	X	470	6.3	85	282	10	50	1900	5	5	5.4	115	17.3
TCN4108M006#0055E	4	1000	6.3	85	600	20	55	1860	5	4	11.6	130	26
TCN4158M006#0055E	4	1500	6.3	85	900	20	55	1860	5	4	17.4	195	39
10 Volt @ 85°C													
TCJH476M010#0100E	H	47	10	105	47	6	100	1000	3	3	1.7	115	17.3
TCJC476M010#0100E	C	47	10	125	47	6	100	1300	1	3	1.7	34	8.8
TCJD686M010#0045E	D	68	10	105	68	6	45	2200	3	3	2.5	27	7.8
TCJD107M010#0045E	D	100	10	105	100	6	45	2200	3	3	3.6	40	11.5
TCJD157M010#0045E	D	150	10	105	150	6	45	2200	3	3	5.4	59	17.2
TCJD227M010#0040E	D	220	10	105	220	6	40	2400	3	3	7.9	87	25.2
TCJ5337M010#0100E	5	330	10	105	330	10	100	1300	2	3	11.9	100	37.8
TCN4687M010#0070E	4	680	10	105	680	20	70	1650	3	4	24.5	275	55.0
16 Volt @ 85°C													
TCJH336M016#0150E	H	33	16	105	52.8	6	150	800	3	3	3.3	223	33.4
TCNT336M016#0200E	T	33	16	105	52.8	6	200	700	3	4	3.3	277	33.4
TCNT476M016#0150E	T	47	16	105	75.2	6	150	800	3	4	4.7	395	47.6
TCJD686M016#0050E	D	68	16	105	108.8	6	50	2100	2	3	6.7	74	21.5
TCJD107M016#0050E	D	100	16	105	160	6	50	2100	2	3	9.9	109	31.6
TCNX157M016#0100E	X	150	16	105	240	6	100	1300	3	4	14.9	316	47.4
TCJD227M016#0050E	D	220	16	105	352	10	50	2100	2	3	21.8	240	69.5
TCN4227M016#0070E	4	220	16	105	352	20	70	1650	2	4	21.8	245	49
TCN4337M016#0070E	4	330	16	105	528	20	70	1650	3	4	32.7	367	73.5
TCJ5337M016#0100E	5	330	16	105	528	10	100	1300	2	3	32.7	274	104.2
TCN4477M016#0070E	4	470	16	105	752	20	70	1650	3	4	46.6	523	104.8
TCN4477M016#0100E	4	470	16	105	752	20	100	1380	3	4	46.6	523	104.8
TCJ5477M016#0100E	5	470	16	105	752	10	100	1300	3	3	46.6	391	148.5
20 Volt @ 85°C													
TCJD686M020#0055E	D	68	20	105	136	6	55	2000	3	3	8.4	92	26.7
TCJD107M020#0055E	D	100	20	105	200	6	55	2000	3	3	12.4	136	39.3
TCN4227M020#0100E	4	220	20	85	440	10	100	1380	5	4	27.2	305	61.1
25 Volt @ 85°C													
TCNT226M025#0200E	T	22	25	105	55	6	200	700	3	4	4.3	364	43.9
TCNT336M025#0250E	T	33	25	105	82.5	10	250	600	3	4	6.5	547	65.8
TCNX476M025#0100E	X	47	25	105	117.5	6	100	1300	2	5	9.2	195	29.3
TCJD686M025#0070E	D	68	25	105	170	6	70	1800	2	3	13.3	146	42.3
TCJD107M025#0070E	D	100	25	105	250	6	70	1800	2	3	19.6	215	62.3
TCN4107M025#0100E	4	100	25	105	250	6	100	1380	2	4	19.6	219	43.9
TCN4157M025#0070E	4	150	25	105	375	6	70	1650	2	4	29.3	329	65.9
TCN8157M025#0070E	8	150	25	105	375	8	70	1650	2	3	29.3	329	65.9
TCN4227M025#0100E	4	220	25	105	550	10	100	1380	3	4	43.0	483	96.7
35 Volt @ 85°C													
TCNL475M035#0300E	L	4.7	35	105	16.5	6	300	600	2	5	1.8	186	18.6
TCNT475M035#0200E	T	4.7	35	105	16.5	10	200	700	3	4	1.8	154	18.6
TCNT106M035#0150E	T	10	35	105	35	10	150	800	3	4	3.9	328	39.5
TCNT106M035#0200E	T	10	35	105	35	10	200	700	3	4	3.9	328	39.5
TCJC156M035#0200E	C	15	35	105	52.5	6	200	900	3	3	5.8	116	30.3
TCJD226M035#0100E	D	22	35	105	77	6	100	1500	2	3	8.5	94	27.1
TCJD336M035#0070E	D	33	35	105	115.5	6	70	1800	2	3	12.8	141	40.7
TCNX476M035#0150E	X	47	35	105	165	10	150	1100	3	4	18.2	387	58.0
TCNZ476M035#0150E	Z	47	35	105	165	10	150	1100	3	4	18.2	387	58.0
TCN4107M035#0100E	4	100	35	105	350	10	100	1380	2	3	38.8	435	87.1
TCN8107M035#0100E	8	100	35	105	350	10	100	1380	2	3	38.8	435	87.1
50 Volt @ 85°C													
TCJC685M050#0200E	C	6.8	50	105	34	8	200	900	3	3	5.4	108	28.2
TCJD106M050#0120E	D	10	50	105	50	10	120	1400	3	3	8.0	87	25.3
TCJE156M050#0070E	E	15	50	105	75	6	70	1900	3	3	11.9	93	38

Energy is calculated by this formula (consider derating factor):

$$\text{Energy} = \frac{1}{2} C \times ((V_r \times X)^2 - V_r^2)$$

where C = Capacitance

V_r = Rated Voltage

X = Recommended derating factor

V_x = 3V (invariable)

Moisture Sensitivity Level (MSL) is defined according to J-STD-020.

All technical data relates to an ambient temperature of +25°C. Capacitance is measured at 120Hz, 0.5RMS with DC bias of 2.2 volts. DCL is measured at rated voltage after 5 minutes.

ESR allowed to move up to 1.25 times catalog limit post mounting.

For typical weight and composition see page 276.

NOTE: AVX reserves the right to supply higher voltage ratings in the same case size, to the same reliability standards.

RECOMMENDED DERATING FACTOR

Voltage and temperature derating as percentage of Vr

Product Category 1

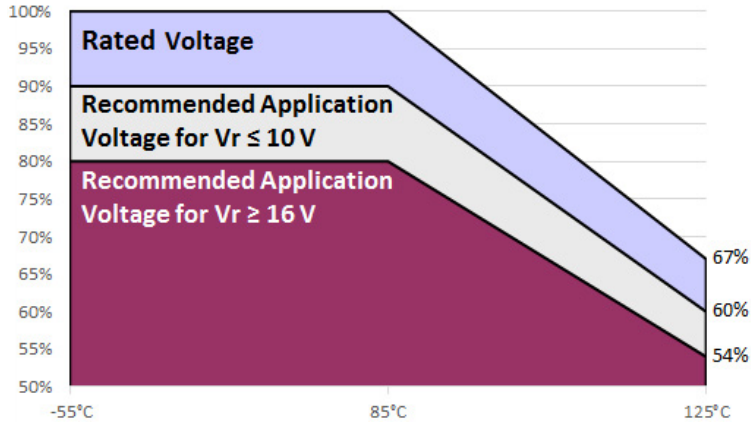

Product Category 2

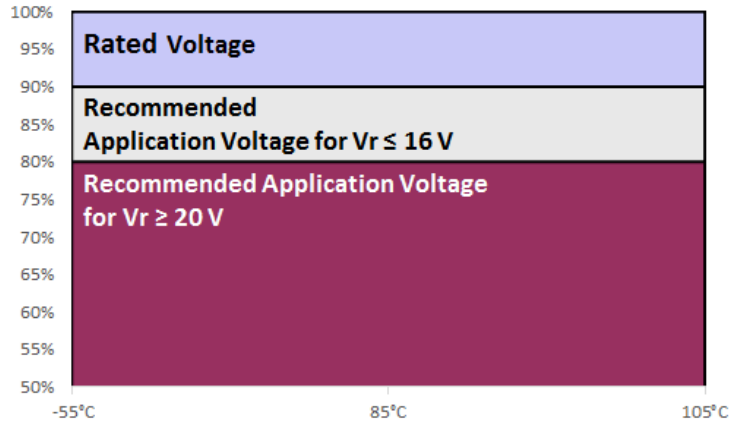

Product Category 3

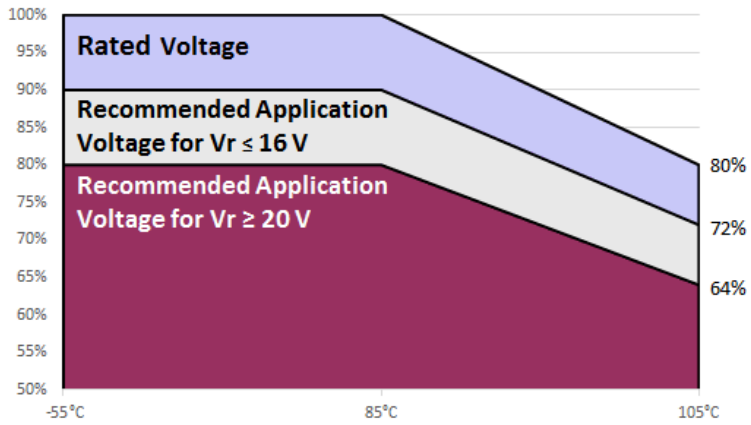

Product Category 5

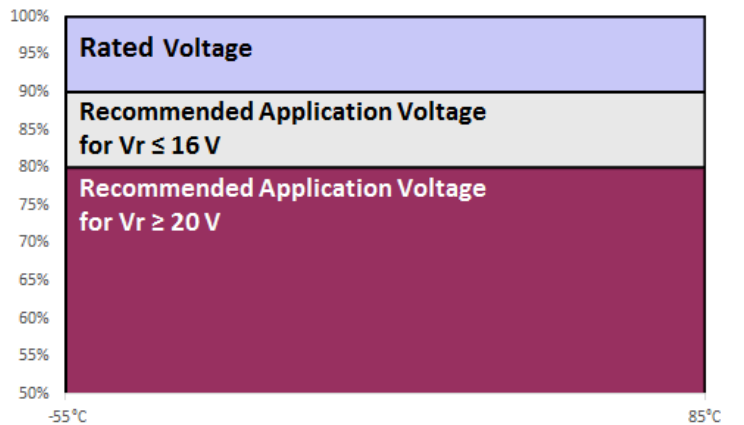

PRODUCT CATEGORY 1 (TEMPERATURE RANGE -55°C TO +125°C)

TEST	Condition	Characteristics								
Endurance	Apply rated voltage (Ur) at 85°C and /or 2/3 rated voltage (Ur) at 125°C for 2000 hours through a circuit impedance of $\leq 0.1\Omega/V$. Stabilize at room temperature for 1-2 hours before measuring.	Visual examination	no visible damage							
		DCL	1.25 x initial limit							
		$\Delta C/C$	within $\pm 20\%$ of initial value							
		DF	1.5 x initial limit							
		ESR	2 x initial limit							
Storage Life	Store at 125°C, no voltage applied, for 2000 hours. Stabilize at room temperature for 1-2 hours before measuring.	Visual examination	no visible damage							
		DCL	2 x initial limit							
		$\Delta C/C$	within $\pm 20\%$ of initial value							
		DF	1.5 x initial limit							
		ESR	2 x initial limit							
Humidity	Store at 65°C and 95% relative humidity for 500 hours, with no applied voltage. Stabilize at room temperature and humidity for 1-2 hours before measuring.	Visual examination	no visible damage							
		DCL	3 x initial limit							
		$\Delta C/C$	within +30/-20% of initial value							
		DF	1.5 x initial limit							
		ESR	2 x initial limit							
Temperature Stability	Step	Temperature°C	Duration(min)							
	1	+20	15		+20°C	-55°C	+20°C	+85°C	+125°C	+20°C
	2	-55	15	DCL	IL*	n/a	IL*	10 x IL*	12.5 x IL*	IL*
	3	+20	15	$\Delta C/C$	n/a	+0/-20%	$\pm 5\%$	+20/-0%	+30/-0%	$\pm 5\%$
	4	+85	15	DF	IL*	1.5 x IL*	IL*	1.5 x IL*	2 x IL*	IL*
	5	+125	15							
	6	+20	15							
Surge Voltage	Apply 1.3x 0.67x rated voltage (Ur) at 125°C for 1000 cycles of duration 6 min (30 sec charge, 5 min 30 sec discharge) through a charge / discharge resistance of 1000 Ω	Visual examination	no visible damage							
		DCL	initial limit							
		$\Delta C/C$	within +10/-20% of initial value for Vr $\leq 10V$ within +20/-30% of initial value for Vr $\geq 16V$							
		DF	1.25 x initial limit							
Mechanical Shock	MIL-STD-202, Method 213, Condition C	Visual examination	no visible damage							
		DCL	initial limit							
		$\Delta C/C$	within $\pm 5\%$ of initial value							
		DF	initial limit							
		ESR	initial limit							
Vibration	MIL-STD-202, Method 204, Condition D	Visual examination	no visible damage							
		DCL	initial limit							
		$\Delta C/C$	within $\pm 5\%$ of initial value							
		DF	initial limit							
		ESR	initial limit							

*Initial Limit

Initial measurement max. 1hr after the removal from dry pack or after pretreatment at 85°C for 24 hours.

PRODUCT CATEGORY 2, 3 (TEMPERATURE RANGE -55°C TO +105°C)

TEST	Condition	Characteristics								
Endurance	Apply rated voltage (Ur) at 85°C for 2000 hours through a circuit impedance of $\leq 0.1\Omega/V$ (all CATEGORIES). And / or apply rated voltage (Ur) (CATEGORY 2) or 0.8x rated voltage (CATEGORY 3) at 105°C for 2000 hours through a circuit impedance of $\leq 0.1\Omega/V$. Always stabilize at room temperature for 1-2 hours before measuring.	Visual examination	no visible damage							
		DCL	1.25 x initial limit							
		$\Delta C/C$	within +10/-20% of initial value for $V_r \leq 16V$ within $\pm 20\%$ of initial value for $V_r \geq 20V$							
		DF	1.5 x initial limit							
		ESR	2 x initial limit							
Storage Life	Store at 105°C, no voltage applied, for 2000 hours. Stabilize at room temperature for 1-2 hours before measuring.	Visual examination	no visible damage							
		DCL	1.25 x initial limit							
		$\Delta C/C$	within +10/-20% of initial value for $V_r \leq 16V$ within $\pm 20\%$ of initial value for $V_r \geq 20V$							
		DF	1.5 x initial limit							
		ESR	2 x initial limit							
Humidity	Store at 65°C and 95% relative humidity for 500 hours, with no applied voltage. Stabilize at room temperature and humidity for 1-2 hours before measuring.	Visual examination	no visible damage							
		DCL	3 x initial limit							
		$\Delta C/C$	within +30/-20% of initial value							
		DF	1.5 x initial limit							
		ESR	2 x initial limit							
Temperature Stability	Step	Temperature°C	Duration(min)		+20°C	-55°C	+20°C	+85°C	+105°C	+20°C
	1	+20	15							
	2	-55	15	DCL	IL*	n/a	IL*	10 x IL*	12.5 x IL*	IL*
	3	+20	15	$\Delta C/C$	n/a	+0/-20%	$\pm 5\%$	+20/-0%	+30/-0%	$\pm 5\%$
	4	+85	15	DF	IL*	1.5 x IL*	IL*	1.5 x IL*	2 x IL*	IL*
	5	+105	15							
	6	+20	15							
Surge Voltage	Apply 1.3x rated voltage (Ur) at 105°C for CATEGORY 2, or apply 1.3x 0.8x rated voltage (Ur) at 105°C for CATEGORY 3 for 1000 cycles of duration 6 min (30 sec charge, 5 min 30 sec discharge) through a charge / discharge resistance of 1000 Ω	Visual examination	no visible damage							
		DCL	initial limit							
		$\Delta C/C$	within +10/-20% of initial value for $V_r \leq 16V$ within +20/-30% of initial value for $V_r \geq 20V$							
		DF	1.25 x initial limit							
Mechanical Shock	MIL-STD-202, Method 213, Condition C	Visual examination	no visible damage							
		DCL	initial limit							
		$\Delta C/C$	within $\pm 5\%$ of initial value							
		DF	initial limit							
		ESR	initial limit							
Vibration	MIL-STD-202, Method 204, Condition D	Visual examination	no visible damage							
		DCL	initial limit							
		$\Delta C/C$	within $\pm 5\%$ of initial value							
		DF	initial limit							
		ESR	initial limit							

*Initial Limit

Initial measurement max. 1hr after the removal from dry pack or after pretreatment at 85°C for 24 hours.

PRODUCT CATEGORY 5 (TEMPERATURE RANGE -55°C TO +85°C)

TEST	Condition			Characteristics					
Endurance	Apply rated voltage (Ur) at 85°C for 2000 hours through a circuit impedance of $\leq 0.1\Omega/V$. Stabilize at room temperature for 1-2 hours before measuring.			Visual examination	no visible damage				
				DCL	1.25 x initial limit				
				$\Delta C/C$	within +10/-20% of initial value for Vr $\leq 16V$ within $\pm 20\%$ of initial value for Vr $\geq 20V$				
				DF	1.5 x initial limit				
				ESR	2 x initial limit				
Storage Life	Store at 85°C, no voltage applied, for 2000 hours. Stabilize at room temperature for 1-2 hours before measuring.			Visual examination	no visible damage				
				DCL	1.25 x initial limit				
				$\Delta C/C$	within +10/-20% of initial value for Vr $\leq 16V$ within $\pm 20\%$ of initial value for Vr $\geq 20V$				
				DF	1.5 x initial limit				
				ESR	2 x initial limit				
Humidity	Store at 65°C and 95% relative humidity for 500 hours, with no applied voltage. Stabilize at room temperature and humidity for 1-2 hours before measuring.			Visual examination	no visible damage				
				DCL	5 x initial limit				
				$\Delta C/C$	within +40/-20% of initial value				
				DF	1.5 x initial limit				
				ESR	2 x initial limit				
Temperature Stability	Step	Temperature°C	Duration(min)		+20°C	-55°C	+20°C	+85°C	+20°C
	1	+20	15						
	2	-55	15	DCL	IL*	n/a	IL*	10 x IL*	IL*
	3	+20	15	$\Delta C/C$	n/a	+0/-20%	$\pm 5\%$	+20/-0%	$\pm 5\%$
	4	+85	15	DF	IL*	1.5 x IL*	IL*	1.5 x IL*	IL*
	5	+20	15						
Surge Voltage	Apply 1.3x rated voltage (Ur) at 85°C for 1000 cycles of duration 6 min (30 sec charge, 5 min 30 sec discharge) through a charge / discharge resistance of 10000 Ω			Visual examination	no visible damage				
				DCL	initial limit				
				$\Delta C/C$	within +10/-20% of initial value for Vr $\leq 16V$ within +20/-30% of initial value for Vr $\geq 20V$				
				DF	1.25 x initial limit				
				ESR	initial limit				
Mechanical Shock	MIL-STD-202, Method 213, Condition C			Visual examination	no visible damage				
				DCL	initial limit				
				$\Delta C/C$	within $\pm 5\%$ of initial value				
				DF	initial limit				
				ESR	initial limit				
Vibration	MIL-STD-202, Method 204, Condition D			Visual examination	no visible damage				
				DCL	initial limit				
				$\Delta C/C$	within $\pm 5\%$ of initial value				
				DF	initial limit				
				ESR	initial limit				

*Initial Limit

Initial measurement max. 1hr after the removal from dry pack or after pretreatment at 85°C for 24 hours.

J-CAP™ Series

Highest Joules/cc Conductive Polymer Solid Electrolytic Chip Capacitors



SOLID ELECTROLYTIC CAPACITOR ROADMAP

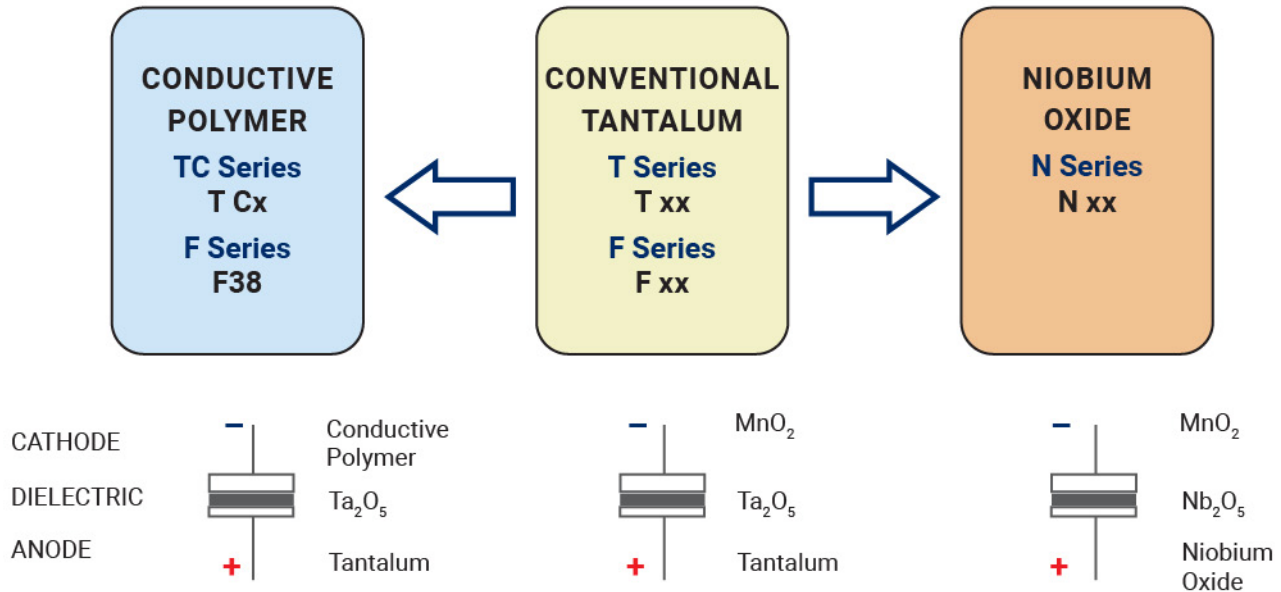

FIVE CAPACITOR CONSTRUCTION STYLES

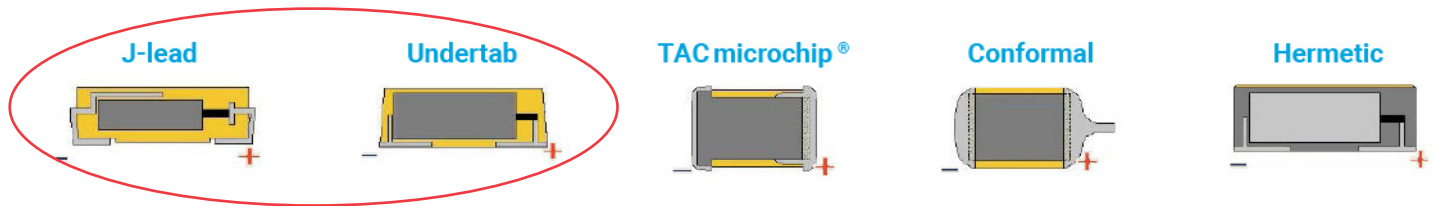

SERIES LINE UP : Conductive Polymer

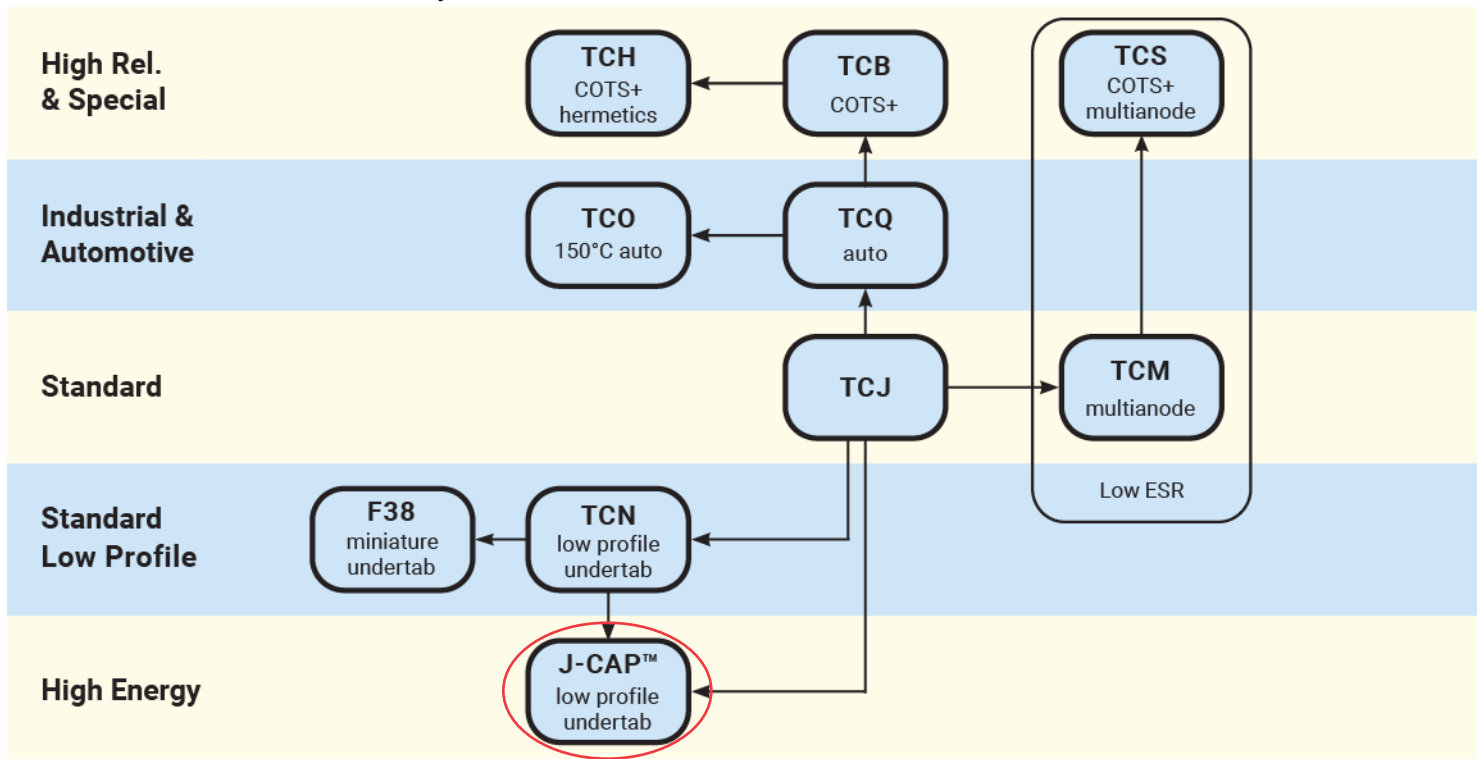

F38 Series

Conductive Polymer, Miniature, Undertab Solid Electrolytic Chip Capacitors



FEATURES

- Conductive Polymer Electrode
- Benign Failure Mode Under Recommended Use Conditions
- Compliant to the RoHS3 directive 2015/863/EU
- SMD Facedown
- Small and Low Profile
- High Volumetric Efficiency
- 100% Surge Current Tested

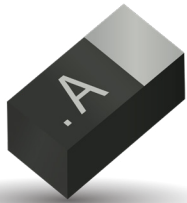

APPLICATIONS

- Smartphone
- Tablet PC
- Wireless Module
- Portable Game
- Bulk Decoupling of SoC (System on Chip)

CASE DIMENSIONS:

millimeters (inches)

Code	EIA Code	EIA Metric	L	W ₁	W ₂	H	S ₁	S ₂
M	0603	1608-09	1.60 ^{+0.20} _{-0.10} (0.063 ^{+0.008} _{-0.004})	0.85 ^{+0.20} _{-0.10} (0.033 ^{+0.008} _{-0.004})	0.65±0.10 (0.026±0.004)	0.80±0.10 ⁻¹ (0.031±0.004)	0.50±0.10 (0.020±0.004)	0.60±0.10 (0.024±0.004)
S	0805	2012-09	2.00 ^{+0.20} _{-0.10} (0.079 ^{+0.008} _{-0.004})	1.25 ^{+0.20} _{-0.10} (0.049 ^{+0.008} _{-0.004})	0.90±0.10 (0.035±0.004)	0.80±0.10 (0.031±0.004)	0.50±0.10 (0.020±0.004)	1.00±0.10 (0.039±0.004)
U	0402	1106-06	1.10±0.05 (0.043±0.002)	0.60±0.05 (0.024±0.002)	0.35±0.05 (0.014±0.002)	0.55±0.05 (0.022±0.002)	0.30±0.05 (0.012±0.002)	0.50±0.05 (0.020±0.002)

*1 F380J476MMAAXE: 1.0mm Max.

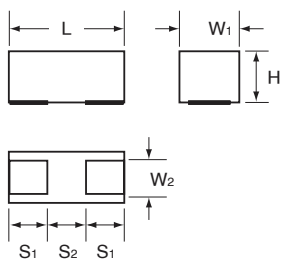

MARKING

U CASE

M CASE

S CASE



Rated Voltage Code

Rated Voltage Code

HOW TO ORDER

F38

Type

1A

Rated Voltage

225

Capacitance Code

pF code: 1st two digits represent significant figures, 3rd digit represents multiplier (number of zeros to follow)

M

Tolerance M=±20%

M

Case Size See table above

□

Packaging

Reel Dia (φ180)	Tape Width (mm)
A	8

□□□□□

Special Code

AXE = Rated temperature 60°C and H dimension 1.0mm Max.
 AXEH3 = Rated temperature 60°C and H dimension 1.0mm Max., Low ESR
 LZT = Rated temperature 60°C
 LZTH1 = Rated temperature 60°C, Low ESR

AH1, AH2, AH3 = Low ESR

TECHNICAL SPECIFICATIONS

Category Temperature Range:	-55 to +105°C
Rated Range:	+85°C or +60°C (*2)
Capacitance Tolerance:	±20% at 120Hz
Dissipation Factor:	Refer to next page (120Hz)
ESR 100kHz:	Refer to next page (120Hz)
Leaking Current:	Refer to next page At 20°C after application of rated voltage for 5 minutes Provided that: After 5 minute's application of rated voltage, leakage current at 105°C 10 times or less than 20°C specified value.
Termination Finish:	M, S case: Gold Plating (standard), U case: Sn-3.5Ag Plating (standard)

*2 LZT and AXE: Rated temperature +60°C, Surge and Endurance test temperature +60°C

F38 Series

Conductive Polymer, Miniature, Undertab Solid Electrolytic Chip Capacitors



CAPACITANCE AND RATED VOLTAGE RANGE (LETTER DENOTES CASE SIZE)

Capacitance		Rated Voltage					*Cap Code
μF	Code	4V (0G)	6.3V (0J)	8V (0K)	10V (1A)	25V (1E)	
1.0	105		U				A
2.2	225				M	M	J
4.7	475		U		M/S	S	S
10	106		M/M(AH1,AH2)/S/U		M/M(AH1)/S		a
22	226		M/M(AH3,AH1)/S/S(AH1)		M**/S		j
33	336		M**/S		S**		n
47	476		M**/M**(H3)/S/S(AH1)	S	S**		s
68	686		S**				w
100	107	S**	S**/S**(H1)				A

Released ratings, (Low ESR)

*4 (AXE) Rated temperature 60°C and H dimension 1.0mm Max. Please contact AVX when you need detail spec.

** (LZT) Rated temperature 60°C. Please contact AVX when you need detail spec.

Please contact to your local AVX sales office when these series are being designed in your application.

THE CORRELATIONS AMONG RATED VOLTAGE, SURGE VOLTAGE AND DERATED VOLTAGE

	F38 (Standard)			
Rated Voltage (V) ≤85°C	6.3	8	10	25
85°C Surge Voltage (V)	8	10	13	32
105°C Derated Voltage (V)	5	6.3	8	20

	F38-LZT, F38-AXE		
Rated Voltage (V) ≤60°C	4	6.3	10
60°C Surge Voltage (V)	5.2	8	13
85°C Derated Voltage (V)	2.8	4.5	7.2
105°C Derated Voltage (V)	2	3.3	5

RATINGS & PART NUMBER REFERENCE

AVX Part No.	Case Size	Capacitance (μF)	Rated Voltage (V)	DCL (μA)	DF @ 120Hz (%)	ESR @ 100kHz (mΩ)	100kHz RMS Current (mA)				*3 ΔC/C (%)	MSL
							45°C	60°C	85°C	105°C		
4 Volt												
F380G107MSALZT	S	100	4	80.0	10	200	474	332	-	237	*	3
6.3 Volt												
F380J105MUA	U	1	6.3	0.6	6	1500	100	-	70	50	*	3
F380J475MUA	U	4.7	6.3	20.0	10	1500	100	-	70	50	*	3
F380J106MMA	M	10	6.3	10.0	8	500	224	-	157	112	*	3
F380J106MMAAH1	M	10	6.3	10.0	8	300	289	-	202	144	*	3
F380J106MMAAH2	M	10	6.3	10.0	8	200	354	-	247	177	*	3
F380J106MSA	S	10	6.3	6.3	10	250	424	-	297	212	*	3
F380J106MUA	U	10	6.3	20.0	10	1500	100	-	70	50	*	3
F380J226MMA	M	22	6.3	13.9	10	500	224	-	157	112	*	3
F380J226MMAAH3	M	22	6.3	13.9	10	300	289	-	202	144	*	3
F380J226MMAAH1	M	22	6.3	13.9	10	200	354	-	247	177	*	3
F380J226MSA	S	22	6.3	13.9	10	200	474	-	332	237	*	3
F380J226MSAAH1	S	22	6.3	13.9	10	150	548	-	383	274	*	3
F380J336MMA	M	33	6.3	41.6	10	500	224	157	-	112	*	3
F380J336MSA	S	33	6.3	20.8	10	200	474	-	332	237	*	3
F380J476MMAAXE	M	47	6.3	59.2	10	500	224	157	-	112	*	3
F380J476MMAAXEH3	M	47	6.3	59.2	10	300	289	202	-	144	*	3
F380J476MSA	S	47	6.3	29.6	10	200	474	-	332	237	*	3
F380J476MSAAH1	S	47	6.3	29.6	10	150	548	-	383	274	*	3
F380J686MSALZT	S	68	6.3	86.0	10	200	474	332	-	237	*	3
F380J107MSALZT	S	100	6.3	126.0	10	200	474	332	-	237	*	3
F380J107MSALZTH1	S	100	6.3	126.0	10	150	548	383	-	274	*	3
8 Volt												
F380K476MSA	S	47	8	37.6	10	200	474	-	332	237	*	3
10 Volt												
F381A225MMA	M	2.2	10	10.0	6	500	224	-	157	112	*	3
F381A475MMA	M	4.7	10	10.0	6	500	224	-	157	112	*	3
F381A475MSA	S	4.7	10	4.7	10	300	387	-	271	194	*	3
F381A106MMA	M	10	10	10.0	15	500	224	-	157	112	*	3
F381A106MMAAH1	M	10	10	10.0	15	300	289	-	202	144	*	3
F381A106MSA	S	10	10	10.0	6	200	474	-	332	237	*	3
F381A226MMAAXE	M	22	10	44.0	10	500	224	157	-	112	*	3
F381A226MSA	S	22	10	22.0	10	200	474	-	332	237	*	3
F381A336MSALZT	S	33	10	99.0	10	200	474	332	-	237	*	3
F381A476MSALZT	S	47	10	94.0	10	200	474	332	-	237	*	3
25 Volt												
F381E225MMA	M	2.2	25	10.0	10	500	224	-	157	112	*	3
F381E475MSA	S	4.7	25	11.8	10	500	300	-	210	150	*	3

3: ΔC/C Marked ""

Moisture Sensitivity Level (MSL) is defined according to J-STD-020

Item	All Case (%)
Damp Heat, steady state	-20 to +30
Rapid change of temperature	±20
Resistance soldering heat	±20
Surge	±20
Endurance	±20



The Important Information/Disclaimer is incorporated in the catalog where these specifications came from or available online at www.avx.com/disclaimer/ by reference and should be reviewed in full before placing any order.

F38 Series

Conductive Polymer, Miniature, Undertab Solid Electrolytic Chip Capacitors



RECOMMENDED DERATING FACTOR

Voltage and temperature derating as percentage of Vr

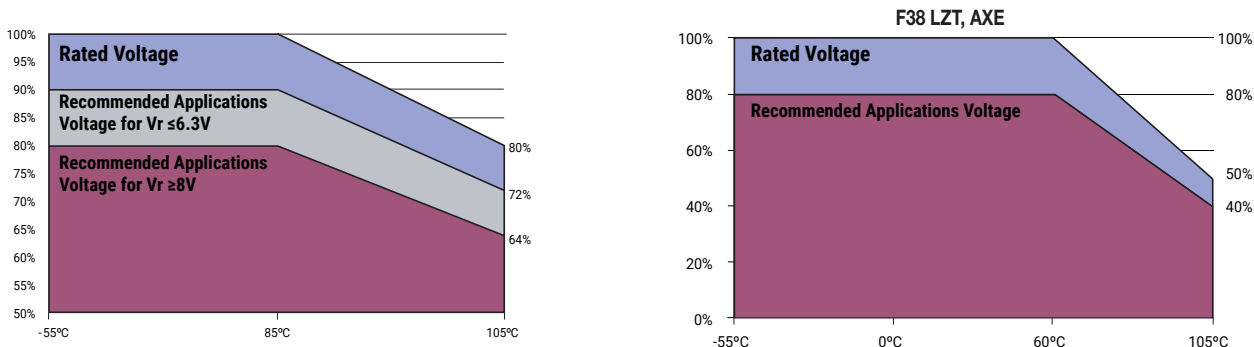

QUALIFICATION TABLE

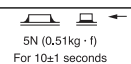
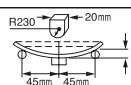
TEST	F38 series (Temperature Range -55°C to +105°C)	
	Condition	
Damp Heat (Steady State)	At 40°C, 90 to 95% R.H., 500 hours (No voltage applied) Capacitance Change Refer to page 229 (*3) Dissipation Factor 200% or less of initial specified value Leakage Current 300% or less of initial specified value	
Temperature Cycles	At -55°C / +105°C, 30 minutes each, 5 cycles Capacitance Change Refer to page 229 (*3) Dissipation Factor 200% or less of initial specified value Leakage Current 400% or less of initial specified value	
Resistance to Soldering Heat	5 seconds reflow at 260°C Capacitance Change Refer to page 229 (*3) Dissipation Factor 200% or less of initial specified value Leakage Current 300% or less of initial specified value	
Surge	After application of surge voltage in series with a 1kΩ resistor at the rate of 30 seconds ON, 30 seconds OFF, for 1000 successive test cycles at 85°C or 60°C (*2), capacitors shall meet the characteristic requirements in the table above. Capacitance Change Refer to page 229 (*3) Dissipation Factor 200% or less of initial specified value Leakage Current 300% or less of initial specified value	
Endurance	After 1000 hours' application of rated voltage in series with a 30 resistor at 85°C or 60°C (*2), capacitors shall meet the characteristic requirements in the table above. Capacitance Change Refer to page 229 (*3) Dissipation Factor 200% or less of initial specified value Leakage Current 400% or less of initial specified value	
Shear Test	After applying the pressure load of 5N for 10±1 seconds horizontally to the center of capacitor side body which has no electrode and has been soldered beforehand on a substrate, there shall be found neither exfoliation nor its sign at the terminal electrode.	
Terminal Strength	Keeping a capacitor surface-mounted on a substrate upside down and supporting the substrate at both of the opposite bottom points 45mm apart from the center of capacitor, the pressure strength is applied with a specified jig at the center of substrate so that the substrate may bend by 1mm as illustrated. Then, there shall be found no remarkable abnormality on the capacitor terminals.	

*2 LZT and AXE: Rated temperature 60°C, Surge and Endurance test temperature 60°C

NOTICE: DESIGN, SPECIFICATIONS ARE SUBJECT TO CHANGE WITHOUT NOTICE.

F38 Series

Conductive Polymer, Miniature, Undertab Solid Electrolytic Chip Capacitors



SOLID ELECTROLYTIC CAPACITOR ROADMAP

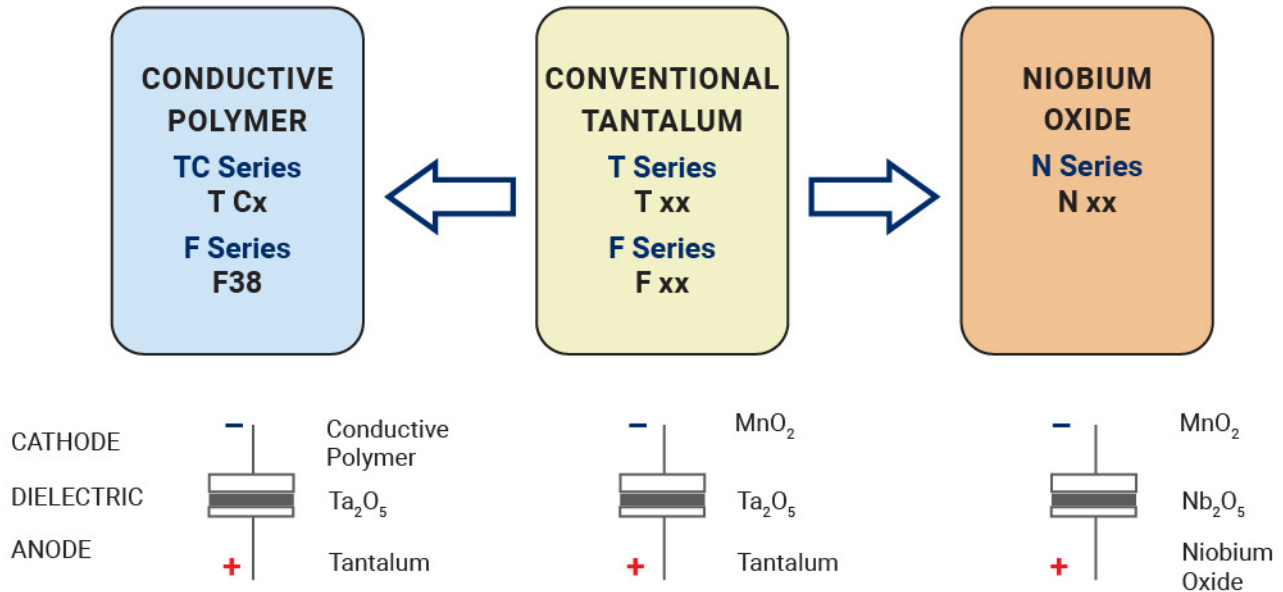

FIVE CAPACITOR CONSTRUCTION STYLES

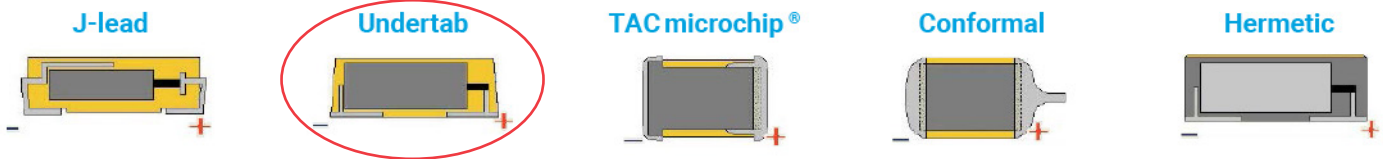

SERIES LINE UP : Conductive Polymer

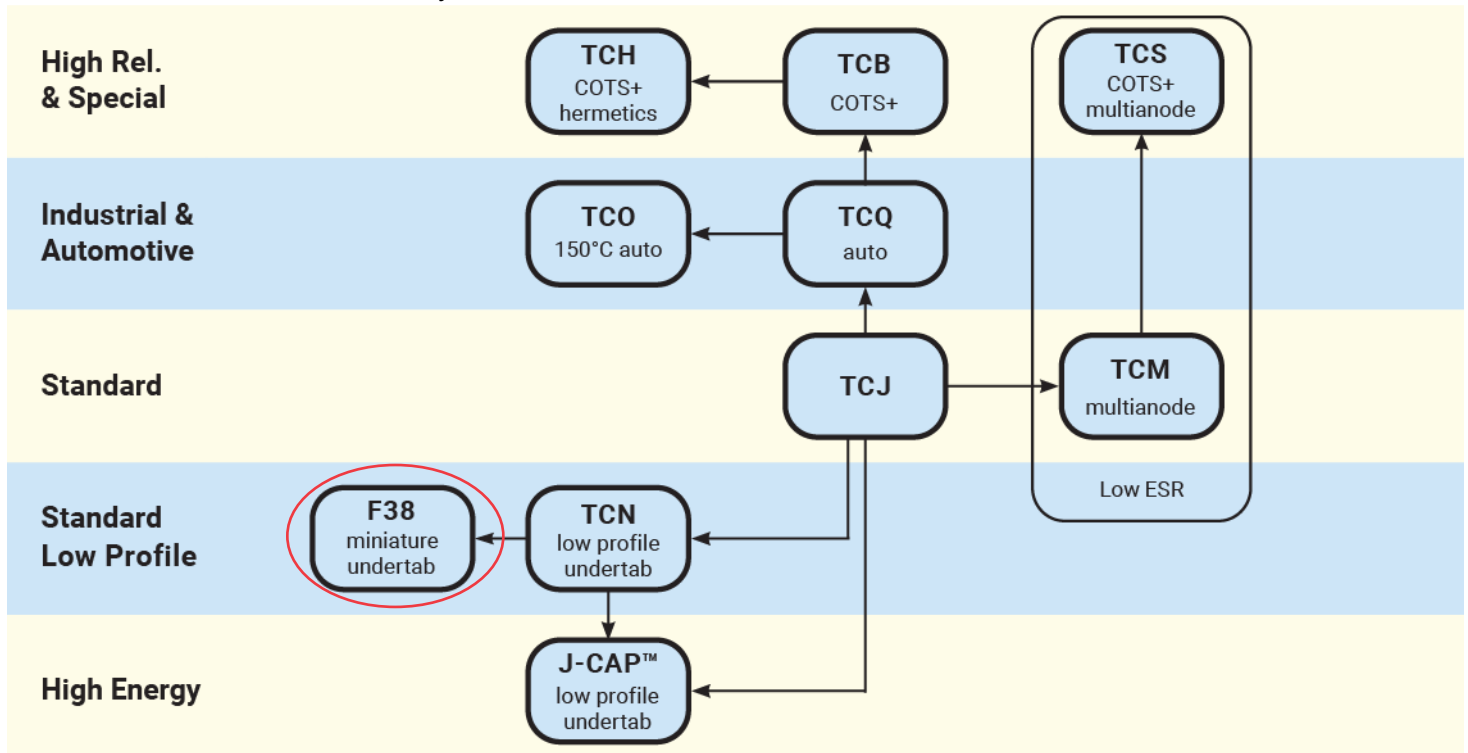

The Important Information/Disclaimer is incorporated in the catalog where these specifications came from or available online at www.avx.com/disclaimer/ by reference and should be reviewed in full before placing any order.

TCO Series

High Temperature Automotive Polymer Chip Capacitors

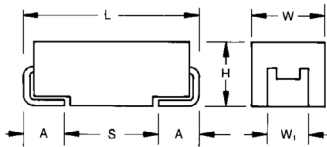
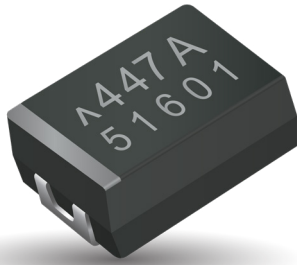

FEATURES

- Conductive Polymer Electrode
- Benign Failure Mode Under Recommended Use Conditions
- Robust Design for Automotive Applications
- Meets Requirements of AEC-Q200
- -55 to +150°C Operation Temperature
- Humidity 85°C/85%RH, Vr, 1000 Hours
- Basic Reliability 1%/1000hrs@85°C Vr with 60% Confidence Level
- DCL 0.1 CV
- 3x reflow 260°C Compatible
- 100% Surge Current Tested



APPLICATIONS

DC/DC converters, Telecommunication (coupling/decoupling), Industrial & special, Automotive (body electronics, cabin controls, infotainment, comfort, after market etc)
 Not recommended for use of conductive polymer parts in high power applications. For more information please see AVX automotive application guide at [avx.com](http://www.avx.com/docs/techinfo/ApplicationGuides/Automotive-Application-Guide.pdf) (see the link: <http://www.avx.com/docs/techinfo/ApplicationGuides/Automotive-Application-Guide.pdf>), or contact manufacturer.

AVX's qualification of TCO capacitors meets requirements of AEC-Q200. TCO series is manufactured in an IATF 16949 certified facility.

MARKING

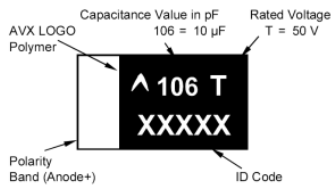

CASE DIMENSIONS:

millimeters (inches)

Code	EIA Code	EIA Metric	L±0.20 (0.008)	W+0.20 (0.008) -0.10 (0.004)	H+0.20 (0.008) -0.10 (0.004)	W ₁ ±0.20 (0.008)	A+0.30 (0.012) -0.20 (0.008)	S Min.
D	2917	7343-31	7.30 (0.287)	4.30 (0.169)	2.90 (0.114)	2.40 (0.094)	1.30 (0.051)	4.40 (0.173)

W₁ dimension applies to the termination width for A dimensional area only.

HOW TO ORDER

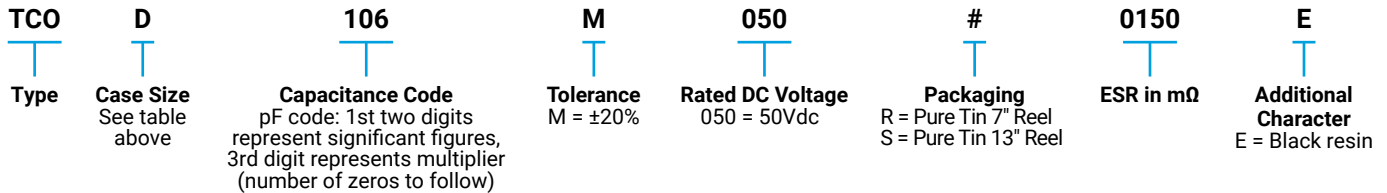

TECHNICAL SPECIFICATIONS

Technical Data:	All technical data relate to an ambient temperature of +25°C
Capacitance Range:	10 µF
Capacitance Tolerance:	±20%
Leakage Current DCL:	0.1CV
Temperature Range:	-55°C to +150°C
	Meets requirements of AEC-Q200

NOTE: Conductive Polymer Capacitors are designed to operate within the limits of the environmental conditions specified for each series. If operated continuously at their maximum temperature and / or humidity limit, or beyond these limits, capacitors may exhibit a parametric shift in capacitance and increases in ESR. These changes may occur earlier if the specified environmental conditions are exceeded. Similarly, their normal operational time period will be significantly extended if their general duty cycle includes operation below maximum temperature within humidity controlled environments. Careful attention should be paid to maximum temperature with associated high humidity environments as well as voltage derating, ripple current and current surges. Please reference the AVX Conductive Polymer Capacitor Guidelines for more information or contact factory for application assistance.

TCO Series

High Temperature Automotive Polymer Chip Capacitors



CAPACITANCE AND RATED VOLTAGE RANGE (LETTER DENOTES CASE SIZE)

Capacitance		Rated Voltage DC (V_R) @ 105°C		
μF	Code	25V (E)	35V (V)	50V (T)
10	106			D(150)
15	156			
22	226			
33	336			

Released ratings, (ESR ratings in mOhms in parentheses)

Note: Voltage ratings are minimum values. AVX reserves the right to supply higher voltage ratings in the same case size, to the same reliability standards.

RATINGS & PART NUMBER REFERENCE

AVX Part No.	Case Size	Capacitance (μF)	Rated Voltage (V)	Maximum Operating Temp. ($^{\circ}\text{C}$)	DCL Max (μA)	DF Max (%)	ESR Max @ 100kHz (m Ω)	100kHz RMS Current (mA)					Humidity 85°C/85% RH, V_r (hrs)	MSL
								45°C	85°C	105°C	125°C	150°C		
50 Volt														
TCOD106M050#0150E	D	10	50	150	50	10	150	1225	857	551	306	184	1000	3

Moisture Sensitivity Level (MSL) is defined according to J-STD-020.

All technical data relates to an ambient temperature of +25C.

Capacitance and DF are measured at 120Hz, 0.5RMS with DC bias of 2.2 volts.

DCL is measured at rated voltage after 5 minutes.

ESR allowed to move up to 1.25 times catalog limit post mounting.

For typical weight and composition see page 276.

RECOMMENDED DERATING FACTOR

Voltage and temperature derating as percentage of V_r

Rated voltage	Operating Temperature		
	$\leq 85^{\circ}\text{C}$	105°C	150°C
$\leq 10\text{V}$	90%	90%	60%
$\geq 16\text{V}$	80%	80%	54%

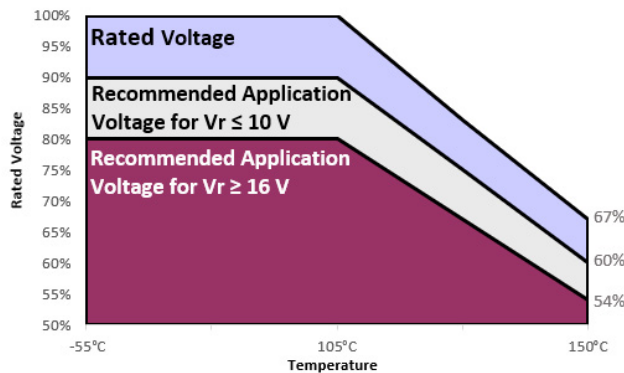

QUALIFICATION TABLE

TEST	TCO series (Temperature range -55°C to 150°C)									
	Condition			Characteristics						
Endurance	Apply rated voltage (Ur) at 105°C for 2000hrs and 2/3 rated voltage (Ur) at 150°C for 1000 hours through a circuit impedance of $\leq 0.1\Omega/V$. Stabilize at room temperature for 1-2 hours before measuring.			Visual examination	no visible damage					
				DCL	2 x initial limit					
				$\Delta C/C$	within +10/-20% of initial value					
				DF	2 x initial limit					
				ESR	2 x initial limit					
Storage Life	Store at 150°C, no voltage applied, for 1000 hours. Stabilize at room temperature for 1-2 hours before measuring.			Visual examination	no visible damage					
				DCL	2x initial limit					
				$\Delta C/C$	within +10/-20% of initial value					
				DF	2 x initial limit					
				ESR	2 x initial limit					
Biased Humidity	Apply rated voltage (Ur) at 85°C, 85% relative humidity for 1000 hours. Stabilize at room temperature and humidity for 1-2 hours before measuring.			Visual examination	no visible damage					
				DCL	2 x initial limit					
				$\Delta C/C$	within +35/-5% of initial value					
				DF	1.5 x initial limit					
				ESR	2 x initial limit					
Temperature Stability	Step	Temperature°C	Duration(min)		+20°C	-55°C	+20°C	+105°C	+150°C	+20°C
	1	+20	15							
	2	-55	15	DCL	IL*	n/a	IL*	10 x IL*	12.5 x IL*	IL*
	3	+20	15							
	4	+105	15	$\Delta C/C$	n/a	$\pm 20\%$	$\pm 5\%$	$\pm 20\%$	$\pm 30\%$	$\pm 5\%$
	5	+150	15	DF	IL*	IL*	IL*	1.5 x IL*	1.5 x IL*	IL*
6	+20	15								
Surge Voltage	Apply 1.3x 2/3x rated voltage (Ur) at 150°C for 1000 cycles, charge / discharge resistance 33 Ω .			Visual examination	no visible damage					
				DCL	initial limit					
				$\Delta C/C$	within +10/-20% of initial value for Vr $\leq 10V$ within +20/-30% of initial value for Vr $\geq 16V$					
				DF	initial limit for Vr $\leq 10V$ 1.25x initial limit for Vr $\geq 16V$					
				ESR	1.25 x initial limit					
Mechanical Shock	MIL-STD-202, Method 213, Condition F			Visual examination	no visible damage					
				DCL	initial limit					
				$\Delta C/C$	within $\pm 10\%$ of initial value					
				DF	initial limit					
				ESR	1.25 x initial limit					
Vibration	MIL-STD-202, Method 204, Condition D			Visual examination	no visible damage					
				DCL	initial limit					
				$\Delta C/C$	within $\pm 10\%$ of initial value					
				DF	initial limit					
				ESR	1.25 x initial limit					

*Initial Limit

For use outside of recommended conditions and special request, please contact AVX.

Initial measurement max. 1hr after the removal from dry pack or after pretreatment at 85°C for 24 hours.

TCO Series

High Temperature Automotive Polymer Chip Capacitors

SOLID ELECTROLYTIC CAPACITOR ROADMAP

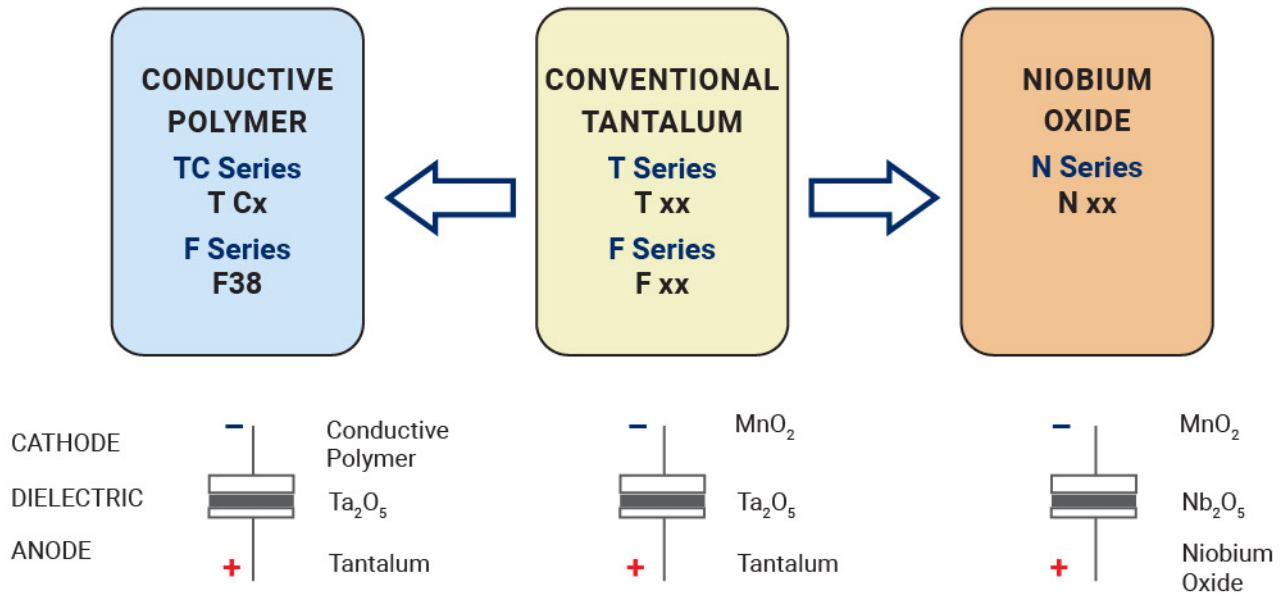

FIVE CAPACITOR CONSTRUCTION STYLES

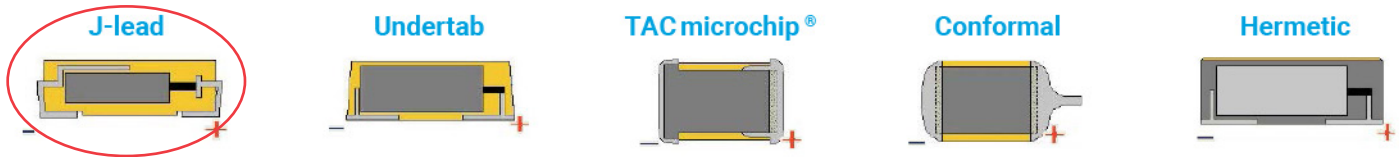

SERIES LINE UP : Conductive Polymer

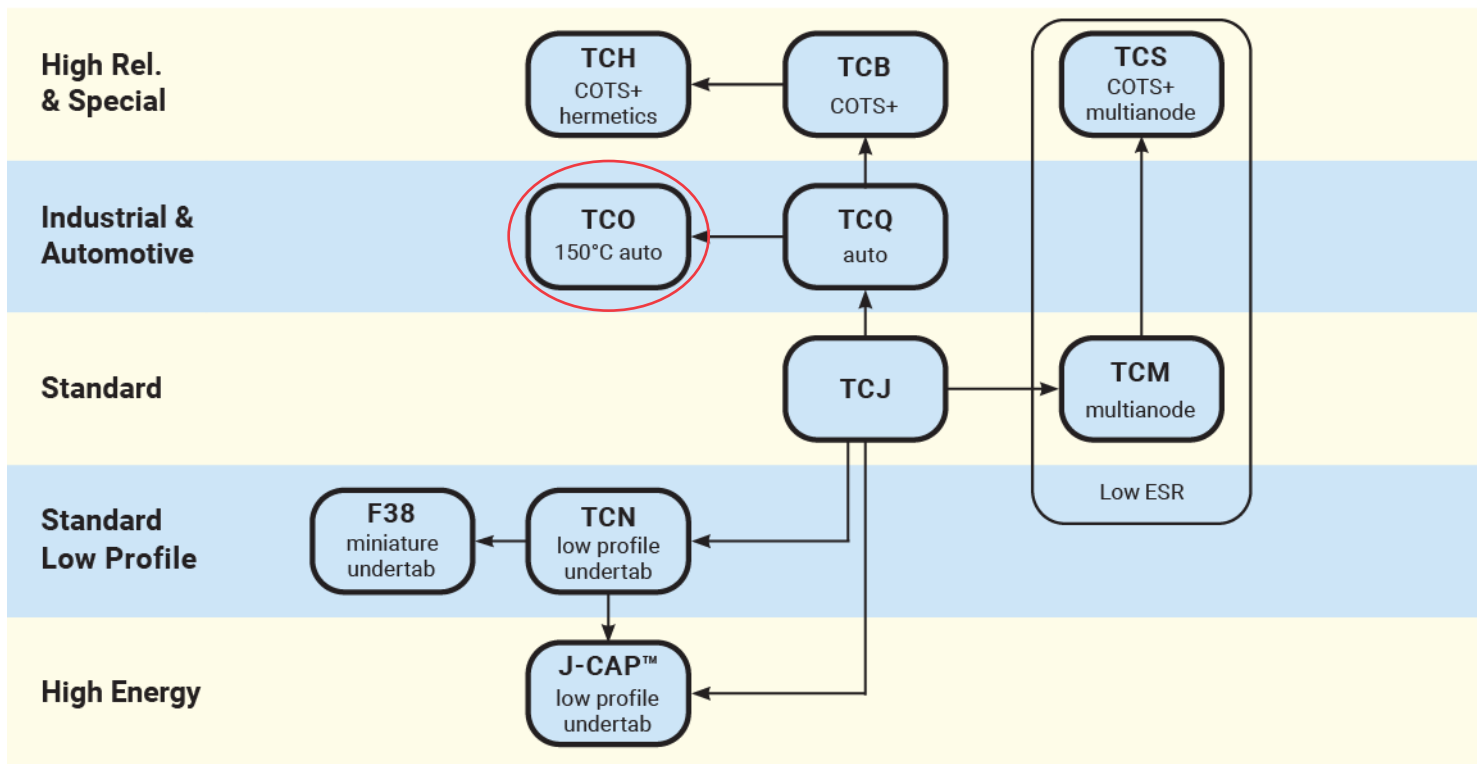

TCQ Series

Automotive Conductive Polymer Chip Capacitors

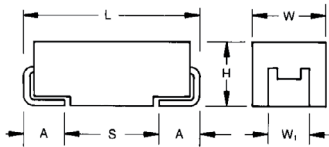

FEATURES

- Conductive Polymer Electrode
- Benign Failure Mode Under Recommended Use Conditions
- Robust Design for Automotive Applications
- Meets Requirements of AEC-Q200
- Humidity 85°C/85%RH, Vr, 1000 hours
- Basic Reliability 1%/1000hrs@85°C Vr with 60% Confidence Level
- -55 to +125°C Operation Temperature
- Full Voltage Range: 2.5-50V
- DCL 0.1 CV
- 3x Reflow 260°C Compatible
- 100% Surge Current Tested



APPLICATIONS

DC/DC converters, Telecommunication (coupling/decoupling), Industrial & special, Automotive (body electronics, cabin controls, infotainment, comfort, after market etc)

Not recommended for use of conductive polymer parts in high power applications. For more information please see AVX automotive application guide at [avx.com](http://www.avx.com) (see the link: <http://www.avx.com/docs/techinfo/ApplicationGuides/Automotive-Application-Guide.pdf>), or contact manufacturer.

AVX's qualification of TCQ capacitors meets requirements of AEC-Q200. TCQ series is manufactured in an IATF 16949 certified facility.

MARKING

B, D, E, U, Y CASE

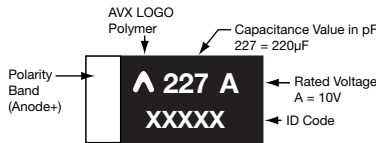

CASE DIMENSIONS:

millimeters (inches)

Code	EIA Code	EIA Metric	L±0.20 (0.008)	W+0.20 (0.008) -0.10 (0.004)	H+0.20 (0.008) -0.10 (0.004)	W1±0.20 (0.008)	A+0.30 (0.012) -0.20 (0.008)	S Min.
B	1210	3528-21	3.50 (0.138)	2.80 (0.110)	1.90 (0.075)	2.20 (0.087)	0.80 (0.031)	1.40 (0.055)
D	2917	7343-31	7.30 (0.287)	4.30 (0.169)	2.90 (0.114)	2.40 (0.094)	1.30 (0.051)	4.40 (0.173)
E	2917	7343-43	7.30 (0.287)	4.30 (0.169)	4.10 (0.162)	2.40 (0.094)	1.30 (0.051)	4.40 (0.173)
U	2924	7361-43	7.30 (0.287)	6.10 (0.240)	4.10 (0.162)	3.10 (0.122)	1.30 (0.051)	4.40 (0.173)
Y	2917	7343-20	7.30 (0.287)	4.30 (0.169)	2.00 (0.079) max	2.40 (0.094)	1.30 (0.051)	4.40 (0.173)

W₁ dimension applies to the termination width for A dimensional area only.

HOW TO ORDER

TCQ

Type

B

Case Size
See table above

476

Capacitance Code
pF code: 1st two digits represent significant figures, 3rd digit represents multiplier (number of zeros to follow)

M

Tolerance
M = ±20%

006

Rated DC Voltage
002 = 2.5Vdc
004 = 4Vdc
006 = 6.3Vdc
010 = 10Vdc
016 = 16Vdc
020 = 20Vdc
025 = 25Vdc
035 = 35Vdc
050 = 50Vdc

#

Packaging
R = Pure Tin 7" Reel
S = Pure Tin 13" Reel

0070

ESR in mΩ

E

Additional Character
E = Black resin

TECHNICAL SPECIFICATIONS

Technical Data:	All technical data relate to an ambient temperature of +25°C
Capacitance Range:	10 µF to 470 µF
Capacitance Tolerance:	±20%
Leakage Current DCL:	0.1CV
Temperature Range:	-55°C to +125°C
	Meets requirements of AEC-Q200

NOTE: Conductive Polymer Capacitors are designed to operate within the limits of the environmental conditions specified for each series. If operated continuously at their maximum temperature and / or humidity limit, or beyond these limits, capacitors may exhibit a parametric shift in capacitance and increases in ESR. These changes may occur earlier if the specified environmental conditions are exceeded. Similarly, their normal operational time period will be significantly extended if their general duty cycle includes operation below maximum temperature within humidity controlled environments. Careful attention should be paid to maximum temperature with associated high humidity environments as well as voltage derating, ripple current and current surges. Please reference the AVX Conductive Polymer Capacitor Guidelines for more information or contact factory for application assistance.

TCQ Series

Automotive Conductive Polymer Chip Capacitors



CAPACITANCE AND RATED VOLTAGE RANGE (LETTER DENOTES CASE SIZE)

Capacitance		Rated Voltage DC (V _R) @ 105°C								
µF	Code	2.5 (e)	4V (G)	6.3V (J)	10V (A)	16V (C)	20V (D)	25V (E)	35V (V)	50V (T)
10	106						B(150)		D(70)	D(90)
15	156					B(90)	B(150)	D(70)	D(125)	
22	226			B(70)	B(70)	B(70)	D(70)	D(100)	D(100)	
33	336			B(70)	B(70)	D(70),Y(70)	D(70)	D(100)	E(65), U(70)	
47	476			B(70)	B(70)	D(70),Y(70)	D(70),Y(70)	E(50)	E(75), U(70)	
68	686			B(70)	D(25,40)	D(70)		E(60)		
100	107	B(70)	B(70)		D(25,40)		E(40)	U(70)		
150	157			D(25,40)	D(25)	E(40)				
220	227		D(25),Y(25)	D(25)	D(25)					
330	337		D(25)	D(25)						
470	477		D(25)							

Released ratings, (ESR ratings in mOhms in parentheses)

Note: Voltage ratings are minimum values. AVX reserves the right to supply higher voltage ratings in the same case size, to the same reliability standards.

RATINGS & PART NUMBER REFERENCE

AVX Part No.	Case Size	Capacitance (µF)	Rated Voltage (V)	Maximum Operating Temp. (°C)	DCL Max (µA)	DF Max (%)	ESR Max @ 100kHz (mΩ)	100kHz RMS Current (mA)				Humidity 85°C/85% RH, Vr (hrs)	MSL
								45°C	85°C	105°C	125°C		
2.5 Volt													
TCQB107M002#0070E	B	100	2.5	125	25	6	70	1336	935	601	334	1000	3
4 Volt													
TCQB107M004#0070E	B	100	4	125	40	8	70	1336	935	601	334	1000	3
TCQD227M004#0025E	D	220	4	125	88	6	25	3000	2100	1350	750	1000	3
TCQY227M004#0025E	Y	220	4	125	88	6	25	2720	1904	1224	680	1000	3
TCQD337M004#0025E	D	330	4	125	132	6	25	3000	2100	1350	750	1000	3
TCQD477M004#0025E	D	470	4	125	188	6	25	3000	2100	1350	750	1000	3
6.3 Volt													
TCQB226M006#0070E	B	22	6.3	125	13.2	6	70	1336	935	601	334	1000	3
TCQB336M006#0070E	B	33	6.3	125	19.8	6	70	1336	935	601	334	1000	3
TCQB476M006#0070E	B	47	6.3	125	28.2	6	70	1336	935	601	334	1000	3
TCQB686M006#0070E	B	68	6.3	125	40.8	8	70	1336	935	601	334	1000	3
TCQD157M006#0025E	D	150	6.3	125	90	6	25	3000	2100	1350	750	1000	3
TCQD157M006#0040E	D	150	6.3	125	90	6	40	2372	1660	1067	593	1000	3
TCQD227M006#0025E	D	220	6.3	125	132	6	25	3000	2100	1350	750	1000	3
TCQD337M006#0025E	D	330	6.3	125	198	6	25	3000	2100	1350	750	1000	3
10 Volt													
TCQB226M010#0070E	B	22	10	125	22	6	70	1336	935	601	334	1000	3
TCQB336M010#0070E	B	33	10	125	33	6	70	1336	935	601	334	1000	3
TCQB476M010#0070E	B	47	10	125	47	6	70	1336	935	601	334	1000	3
TCQD686M010#0025E	D	68	10	125	68	6	25	3000	2100	1350	750	1000	3
TCQD686M010#0040E	D	68	10	125	68	6	40	2372	1660	1067	593	1000	3
TCQD107M010#0025E	D	100	10	125	100	6	25	3000	2100	1350	750	1000	3
TCQD107M010#0040E	D	100	10	125	100	6	40	2372	1660	1067	593	1000	3
TCQD157M010#0025E	D	150	10	125	150	6	25	3000	2100	1350	750	1000	3
TCQD227M010#0025E	D	220	10	125	220	6	25	3000	2100	1350	750	1000	3
16 Volt													
TCQB156M016#0090E	B	15	16	125	24	8	90	1179	825	530	295	1000	3
TCQB226M016#0070E	B	22	16	125	35.2	8	70	1336	935	601	334	1000	3
TCQD336M016#0070E	D	33	16	125	52.8	6	70	1793	1255	807	448	1000	3
TCQY336M016#0070E	Y	33	16	125	52.8	6	70	1626	1138	732	406	1000	3
TCQD476M016#0070E	D	47	16	125	75.2	6	70	1793	1255	807	448	1000	3
TCQY476M016#0070E	Y	47	16	125	75.2	6	70	1626	1138	732	406	1000	3
TCQD686M016#0070E	D	68	16	125	109	8	70	1793	1255	807	448	1000	3
TCQE157M016#0040E	E	150	16	125	240	10	40	2500	1750	1125	625	1000	3
20 Volt													
TCQB106M020#0150E	B	10	20	125	20	8	150	913	639	411	228	1000	3
TCQB156M020#0150E	B	15	20	125	30	8	150	913	639	411	228	1000	3
TCQD226M020#0070E	D	22	20	125	44	6	70	1793	1255	807	448	1000	3
TCQD336M020#0070E	D	33	20	125	66	8	70	1793	1255	807	448	1000	3
TCQD476M020#0070E	D	47	20	125	94	6	70	1793	1255	807	448	1000	3
TCQY476M020#0070E	Y	47	20	125	94	6	70	1626	1138	732	406	1000	3
TCQE107M020#0040E	E	100	20	125	200	10	40	2500	1750	1125	625	1000	3

TCQ Series

Automotive Conductive Polymer Chip Capacitors



RATINGS & PART NUMBER REFERENCE

AVX Part No.	Case Size	Capacitance (μF)	Rated Voltage (V)	Maximum Operating Temp. (°C)	DCL Max (μA)	DF Max (%)	ESR Max @ 100kHz (mΩ)	100kHz RMS Current (mA)				Humidity 85°C/85% RH, Vr (hrs)	MSL
								45°C	85°C	105°C	125°C		
25 Volt													
TCQD156M025#0070E	D	15	25	125	37.5	6	70	1793	1255	807	448	1000	3
TCQD226M025#0100E	D	22	25	125	55	8	100	1500	1050	675	375	1000	3
TCQD336M025#0100E	D	33	25	125	82.5	8	100	1500	1050	675	375	1000	3
TCQE476M025R0050E	E	47	25	125	117.5	10	50	2236	1565	1006	559	1000	3
TCQE686M025R0060E	E	68	25	125	170	10	60	2041	1429	919	510	1000	3
TCQU107M025R0070E	U	100	25	125	250	12	70	2330	1631	1048	582	1000	3
35 Volt													
TCQD106M035#0070E	D	10	35	125	35	6	70	1793	1255	807	448	1000	3
TCQD156M035#0125E	D	15	35	125	52.5	8	125	1342	939	604	335	1000	3
TCQD226M035#0100E	D	22	35	125	77	8	100	1500	1050	675	375	1000	3
TCQU336M035R0070E	U	33	35	125	115.5	12	70	2330	1631	1048	582	1000	3
TCQE336M035R0065E	E	33	35	125	115.5	10	65	1961	1373	883	490	1000	3
TCQE476M035R0075E	E	47	35	125	164.5	10	75	1826	1278	822	456	1000	3
TCQU476M035R0070E	U	47	35	125	164.5	12	70	2330	1631	1048	582	1000	3
50 Volt													
TCQD106M050#0090E	D	10	50	125	50	10	90	1581	1107	712	395	1000	3

Moisture Sensitivity Level (MSL) is defined according to J-STD-020. All technical data relates to an ambient temperature of +25°C. Capacitance and DF are measured at 120Hz, 0.5RMS with DC bias of 2.2 volts. DCL is measured at rated voltage after 5 minutes.

ESR allowed to move up to 1.25 times catalog limit post mounting. For typical weight and composition see page 276.

NOTE: AVX reserves the right to supply higher voltage ratings or tighter tolerance part in the same case size, to the same reliability standards.

RECOMMENDED DERATING FACTOR

Voltage and temperature derating as percentage of Vr

Rated voltage	Operating Temperature		
	≤85°C	105°C	125°C
≤10V	90%	90%	60%
≥16V	80%	80%	54%

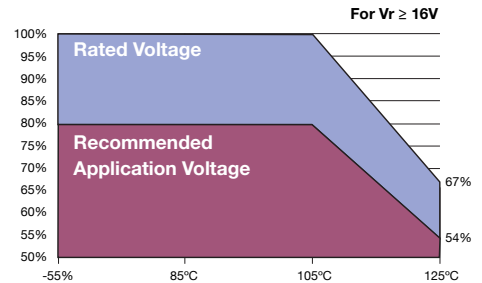
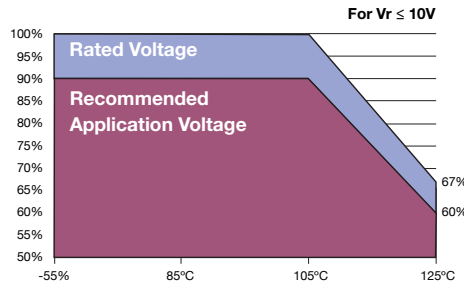

TCQ Series

Automotive Conductive Polymer Chip Capacitors

QUALIFICATION TABLE

TEST	TCQ series (Temperature range -55°C to 125°C)									
	Condition			Characteristics						
Endurance	Apply 2/3 rated voltage (Ur) at 125°C for 2000 hours through a circuit impedance of $\leq 0.1\Omega/V$. Stabilize at room temperature for 1-2 hours before measuring.			Visual examination	no visible damage					
				DCL	2 x initial limit					
				$\Delta C/C$	within +10/-20% of initial value					
				DF	2 x initial limit					
				ESR	2 x initial limit					
Storage Life	Store at 125°C, no voltage applied, for 2000 hours. Stabilize at room temperature for 1-2 hours before measuring.			Visual examination	no visible damage					
				DCL	2x initial limit					
				$\Delta C/C$	within +10/-20% of initial value					
				DF	2 x initial limit					
				ESR	2 x initial limit					
Biased Humidity	Apply rated voltage (Ur) at 85°C, 85% relative humidity for 1000 hours. Stabilize at room temperature and humidity for 1-2 hours before measuring.			Visual examination	no visible damage					
				DCL	2 x initial limit					
				$\Delta C/C$	within +35/-5% of initial value					
				DF	1.5 x initial limit					
				ESR	2 x initial limit					
Temperature Stability	Step	Temperature°C	Duration(min)		+20°C	-55°C	+20°C	+85°C	+125°C	+20°C
	1	+20	15							
	2	-55	15	DCL	IL*	n/a	IL*	10 x IL*	12.5 x IL*	IL*
	3	+20	15							
	4	+85	15	$\Delta C/C$	n/a	$\pm 20\%$	$\pm 5\%$	$\pm 20\%$	$\pm 30\%$	$\pm 5\%$
	5	+125	15	DF	IL*	IL*	IL*	1.2 x IL*	1.5 x IL*	IL*
6	+20	15								
Surge Voltage	Apply 1.3x 2/3x rated voltage (Ur) at 125°C for 1000 cycles of duration 6 min (30 sec charge, 5 min 30 sec discharge) through a charge / discharge resistance of 1000 Ω			Visual examination	no visible damage					
				DCL	initial limit					
				$\Delta C/C$	within +10/-20% of initial value for Vr $\leq 10V$ within +20/-30% of initial value for Vr $\geq 16V$					
				DF	initial limit for Vr $\leq 10V$ 1.25x initial limit for Vr $\geq 16V$					
				ESR	1.25 x initial limit					
Mechanical Shock	MIL-STD-202, Method 213, Condition F			Visual examination	no visible damage					
				DCL	initial limit					
				$\Delta C/C$	within $\pm 10\%$ of initial value					
				DF	initial limit					
				ESR	1.25 x initial limit					
Vibration	MIL-STD-202, Method 204, Condition D			Visual examination	no visible damage					
				DCL	initial limit					
				$\Delta C/C$	within $\pm 10\%$ of initial value					
				DF	initial limit					
				ESR	1.25 x initial limit					

*Initial Limit

For use outside of recommended conditions and special request, please contact AVX.

Initial measurement max. 1hr after the removal from dry pack or after pretreatment at 85°C for 24 hours.

SOLID ELECTROLYTIC CAPACITOR ROADMAP

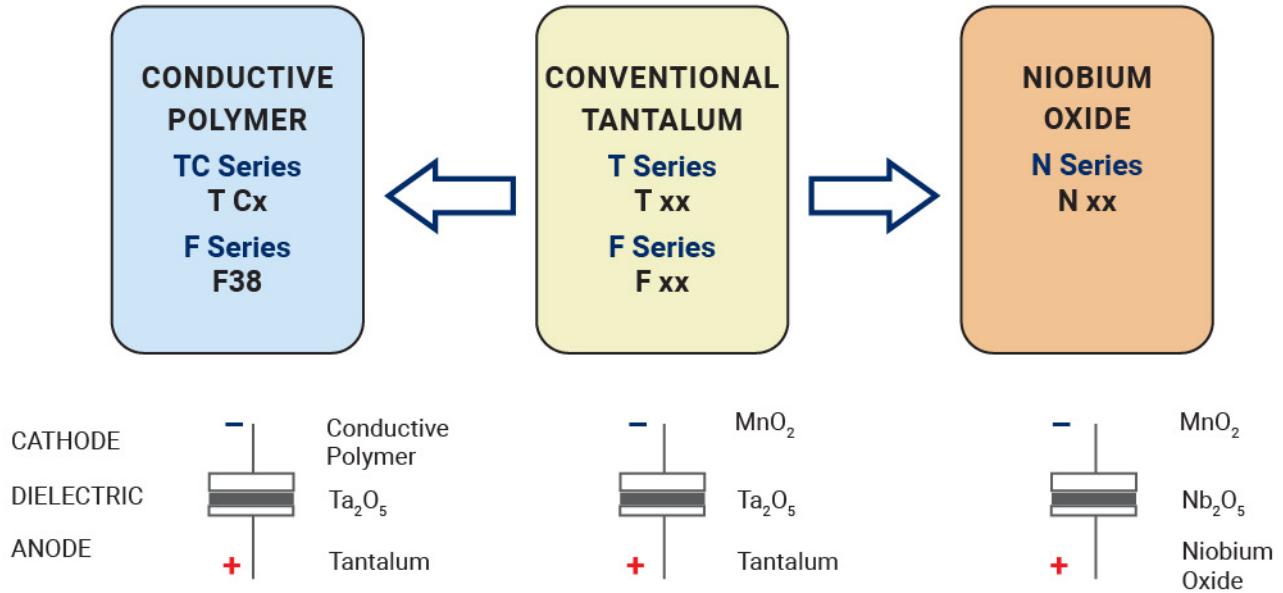

FIVE CAPACITOR CONSTRUCTION STYLES

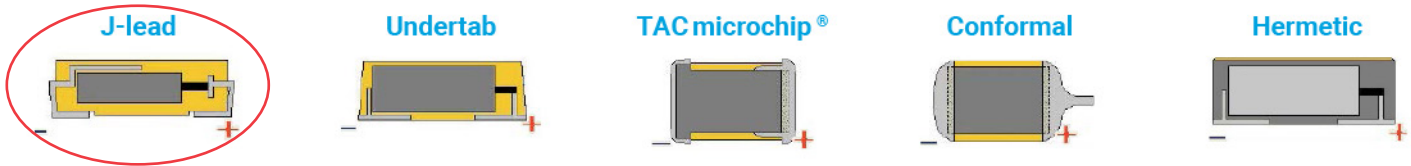

SERIES LINE UP : Conductive Polymer

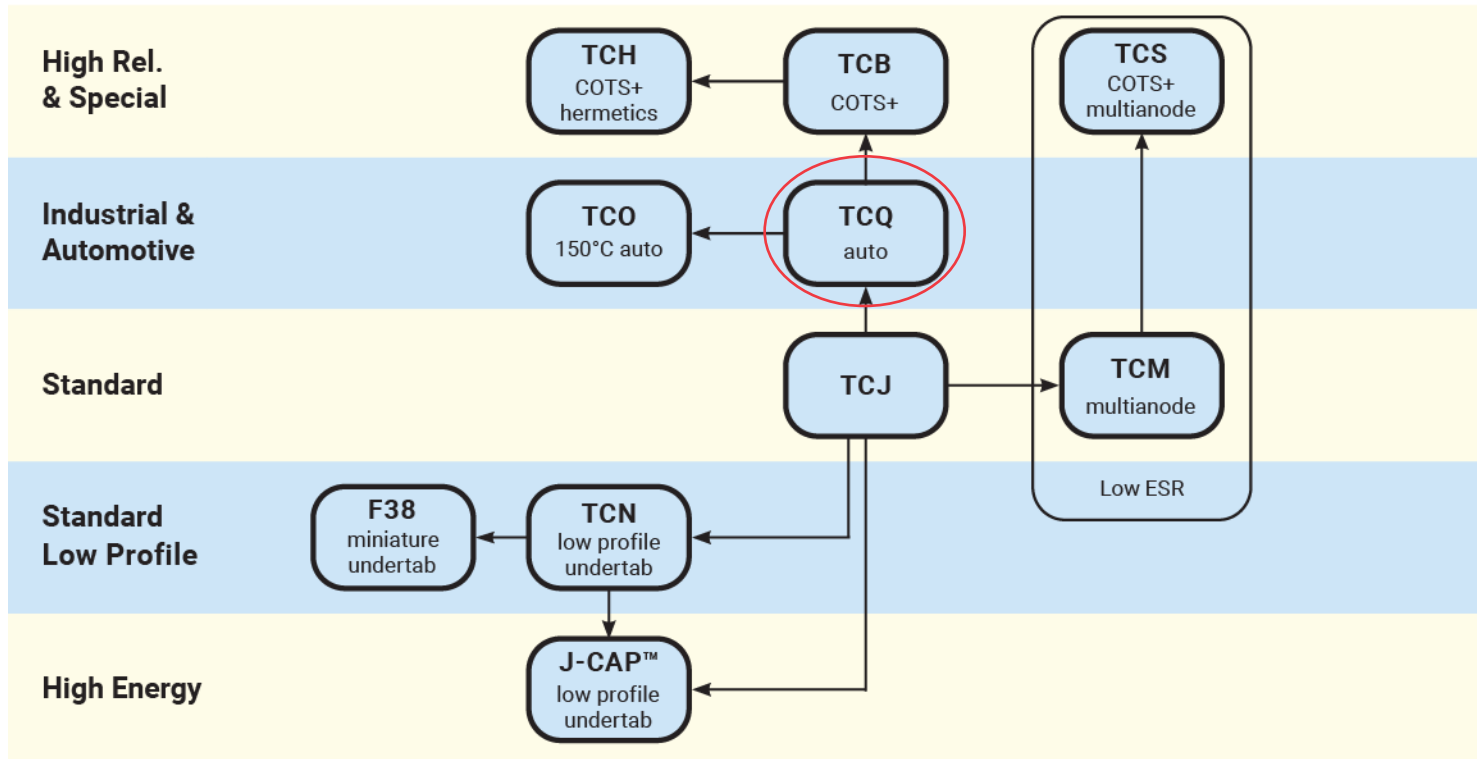

Introduction

Foreword

AVX offers a broad line of solid Tantalum capacitors in a wide range of sizes, styles, and ratings to meet any design needs. This catalog combines into one source AVX's leaded tantalum capacitor information from its worldwide tantalum operations.

The TAP/TEP is rated for use from -55°C to +85°C at rated voltage and up to +125°C with voltage derating. There are three preferred wire forms to choose from which are available on tape and reel, and in bulk for hand insertion.

AVX has a complete tantalum applications service available for use by all our customers. With the capability to prototype and mass produce solid tantalum capacitors in special configurations, almost any design need can be fulfilled.

And if the customer requirements are outside our standard testing, AVX will work with you to define and implement a test or screening plan.

AVX is determined to become the world leader in tantalum capacitor technology and has made, and is continuing to make, significant investments in equipment and research to reach that end. We believe that the investment has paid off with the devices shown on the following pages.

Dipped Radial Capacitors

SOLID TANTALUM RESIN DIPPED SERIES TAP/TEP

The TAP/TEP resin dipped series of miniature tantalum capacitors is available for individual needs in both commercial and professional applications. From computers to automotive to industrial, AVX has a dipped radial for almost any application.

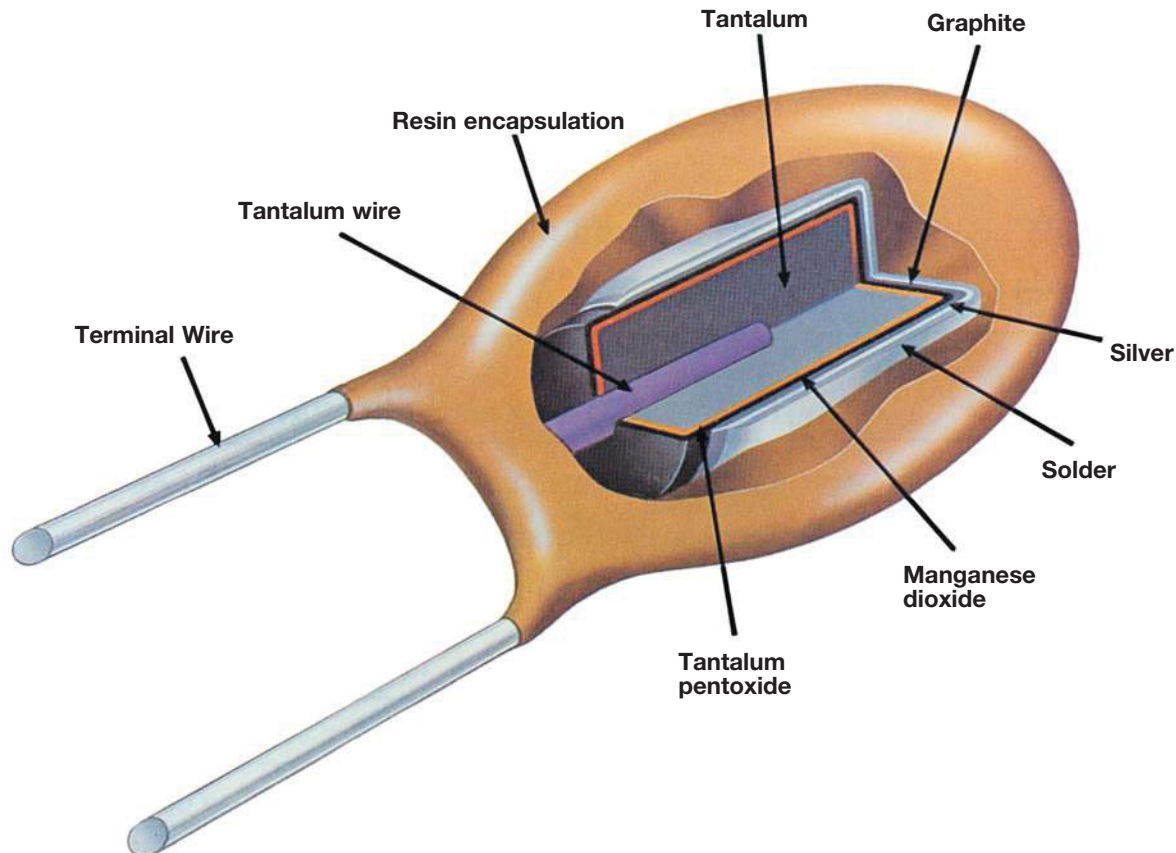

SOLID TANTALUM RESIN DIPPED TAP/TEP

Preferred Wire Forms

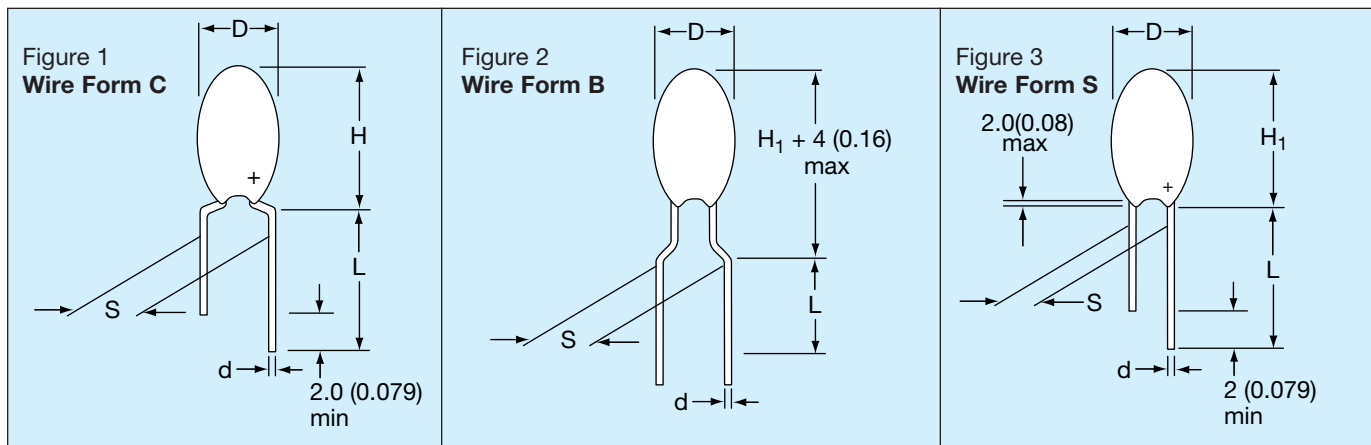

Non-Preferred Wire Forms (Not recommended for new designs)

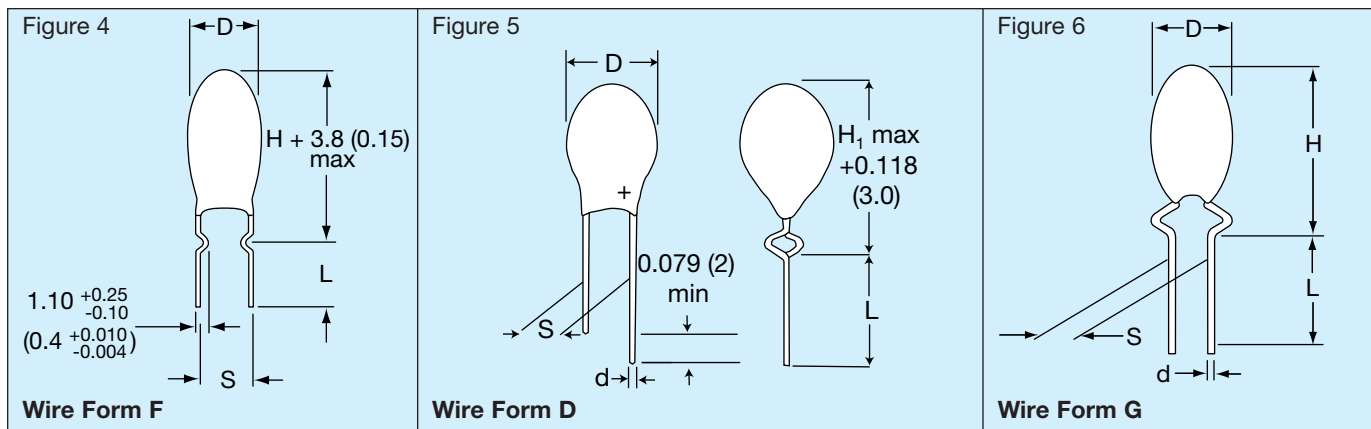

DIMENSIONS

millimeters (inches)

Wire Form	Figure	Case Size	L (see note 1)	S	d	Package Suffixes Available*
Preferred Wire Forms						
C	Figure 1	A - R*	16.0±4.00 (0.630±0.160)	5.00±1.00 (0.200±0.040)	0.50±0.05 (0.020±0.002)	CCS Bulk CRW Tape/Reel CRS Tape/Ammo
B	Figure 2	A - J*	16.0±4.00 (0.630±0.160)	5.00±1.00 (0.200±0.040)	0.50±0.05 (0.020±0.002)	BRW Tape/Reel BRS Tape/Ammo
S	Figure 3	A - J*	16.0±4.00 (0.630±0.160)	2.50±0.50 (0.100±0.020)	0.50±0.05 (0.020±0.002)	SCS Bulk SRW Tape/Reel SRS Tape/Ammo
Non-Preferred Wire Forms (Not recommended for new designs)						
F	Figure 4	A - R	3.90±0.75 (0.155±0.030)	5.00±0.50 (0.200±0.020)	0.50±0.05 (0.020±0.002)	FCS Bulk
D	Figure 5	A - H*	16.0±4.00 (0.630±0.160)	2.50±0.75 (0.100±0.020)	0.50±0.05 (0.020±0.002)	DCS Bulk DTW Tape/Reel DTS Tape/Ammo
G	Figure 6	A - J	16.0±4.00 (0.630±0.160)	3.18±0.50 (0.125±0.020)	0.50±0.05 (0.020±0.002)	GSB Bulk
H	Similar to Figure 1	A - R	16.0±4.00 (0.630±0.160)	6.35±1.00 (0.250±0.040)	0.50±0.05 (0.020±0.002)	HSB Bulk

Notes: (1) Lead lengths can be supplied to tolerances other than those above and should be specified in the ordering information.

(2) For D, H, and H1 dimensions, refer to individual product on following pages.

* For case size availability in tape and reel, please refer to pages 253-254.

Dipped Radial Capacitors

TAP Series

SOLID TANTALUM RESIN DIPPED CAPACITORS

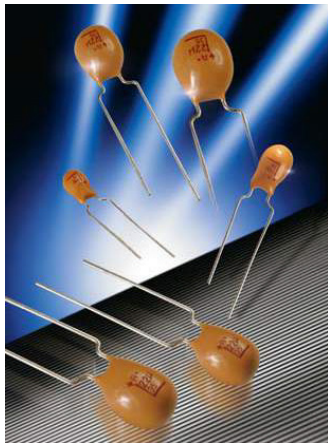

TAP is a professional grade device manufactured with a flame retardant coating and featuring low leakage current and impedance, very small physical sizes and exceptional temperature stability. It is designed and conditioned to operate to +125°C (see page 282 for voltage derating above 85°C) and is available loose or taped and reeled for auto insertion. The 15 case sizes with wide capacitance and working voltage ranges means the TAP can accommodate almost any application.

MAXIMUM CASE DIMENSIONS:

Wire Case	millimeters (inches)		
	C, F, G, H H	B, S, D *H ₁	D
A	8.50 (0.330)	7.00 (0.280)	4.50 (0.180)
B	9.00 (0.350)	7.50 (0.300)	4.50 (0.180)
C	10.0 (0.390)	8.50 (0.330)	5.00 (0.200)
D	10.5 (0.410)	9.00 (0.350)	5.00 (0.200)
E	10.5 (0.410)	9.00 (0.350)	5.50 (0.220)
F	11.5 (0.450)	10.0 (0.390)	6.00 (0.240)
G	11.5 (0.450)	10.0 (0.390)	6.50 (0.260)
H	12.0 (0.470)	10.5 (0.410)	7.00 (0.280)
J	13.0 (0.510)	11.5 (0.450)	8.00 (0.310)
K	14.0 (0.550)	12.5 (0.490)	8.50 (0.330)
L	14.0 (0.550)	12.5 (0.490)	9.00 (0.350)
M	14.5 (0.570)	13.0 (0.510)	9.00 (0.350)
N	16.0 (0.630)		9.00 (0.350)
P	17.0 (0.670)		10.0 (0.390)
R	18.5 (0.730)		10.0 (0.390)

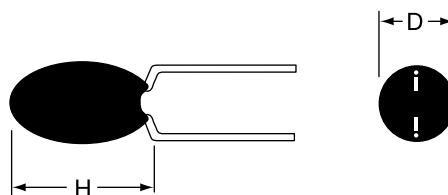

HOW TO ORDER

TAP

Type

475

Capacitance Code
pF code: 1st two digits represent significant figures, 3rd digit represents multiplier (number of zeros to follow)

M

Capacitance Tolerance
K = ±10%
M = ±20%
(For J = ±5% tolerance, please consult factory)

035

Rated DC Voltage

SCS

Suffix indicating wire form and packaging (see page 246)

Dipped Radial Capacitors

TAP Series



TECHNICAL SPECIFICATIONS

Technical Data:	All technical data relate to an ambient temperature of +25°C							
Capacitance Range:	0.10 μ F to 330 μ F							
Capacitance Tolerance:	\pm 20%; \pm 10% (\pm 5% consult your AVX representative for details)							
Rated Voltage DC (V_R)	$\leq +85^\circ\text{C}$:	6.3	10	16	20	25	35	50
Category Voltage (V_C)	$\leq +125^\circ\text{C}$:	4	6.3	10	13	16	23	33
Surge Voltage (V_S)	$\leq +85^\circ\text{C}$:	8	13	20	26	33	46	65
Surge Voltage (V_S)	$\leq +125^\circ\text{C}$:	5	9	12	16	21	28	40
Temperature Range:	-55°C to +125°C							
Environmental Classification:	55/125/56 (IEC 68-2)							
Dissipation Factor:	\leq 0.04 for C_R 0.1-1.5 μ F \leq 0.06 for C_R 2.2-6.8 μ F \leq 0.08 for C_R 10-68 μ F \leq 0.10 for C_R 100-330 μ F							
Reliability:	1% per 1000 hrs. at 85°C with 0.1 Ω /V series impedance, 60% confidence level.							
Qualification:	CECC 30201 - 032							

CAPACITANCE AND RATED VOLTAGE RANGE (LETTER DENOTES CASE SIZE)

Capacitance		Rated Voltage DC (V_R)						
μ F	Code	6.3V	10V	16V	20V	25V	35V	50V
0.10	104						A	A
0.15	154						A	A
0.22	224						A	A
0.33	334						A	A
0.47	474						A	A
0.68	684						A	B
1.0	105				A	A	A	C
1.5	155			A	A	A	A	D
2.2	225		A	A	A	A	B	E
3.3	335	A	A	A	B	B	C	F
4.7	475	A	A	B	C	C	E	G
6.8	685	A	B	C	D	D	F	H
10	106	B	C	D	E	E	F	J
15	156	C	D	E	F	F	H	K
22	226	D	E	F	H	H	K	L
33	336	E	F	F	J	J	M	
47	476	F	G	J	K	M	N	
68	686	G	H	L	N	N		
100	107	H	K	N	N			
150	157	K	N	N				
220	227	M	P	R				
330	337	P	R					

Values outside this standard range may be available on request.

AVX reserves the right to supply capacitors to a higher voltage rating, in the same case size, than that ordered.

MARKING

Polarity, capacitance, rated DC voltage, and an "A" (AVX logo) are laser marked on the capacitor body which is made of flame retardant gold epoxy resin with a limiting oxygen index in excess of 30 (ASTM-D-2863).

- Polarity \pm 20% = Standard (no marking)
- Capacitance \pm 10% = "K" on reverse side of unit
- Voltage \pm 5% = "J" on reverse side of unit
- AVX logo
- Tolerance code:

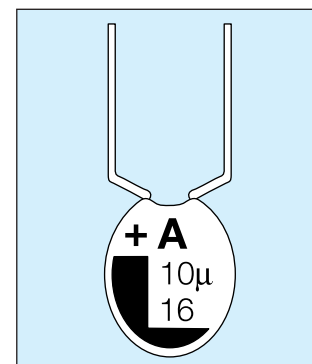

Dipped Radial Capacitors

TAP Series



RATINGS AND PART NUMBER REFERENCE

AVX Part No.	Case Size	Capacitance (µF)	DCL (µA) Max.	DF % Max.	ESR Max. (Ω) @ 100 kHz
6.3 volt @ 85°C (4 volt @ 125°C)					
TAP 335(*)006	A	3.3	0.5	6	13.0
TAP 475(*)006	A	4.7	0.5	6	10.0
TAP 685(*)006	A	6.8	0.5	6	8.0
TAP 106(*)006	B	10	0.5	8	6.0
TAP 156(*)006	C	15	0.8	8	5.0
TAP 226(*)006	D	22	1.1	8	3.7
TAP 336(*)006	E	33	1.7	8	3.0
TAP 476(*)006	F	47	2.4	8	2.0
TAP 686(*)006	G	68	3.4	8	1.8
TAP 107(*)006	H	100	5.0	10	1.6
TAP 157(*)006	K	150	7.6	10	0.9
TAP 227(*)006	M	220	11.0	10	0.9
TAP 337(*)006	P	330	16.6	10	0.7
10 volt @ 85°C (6.3 volt @ 125°C)					
TAP 225(*)010	A	2.2	0.5	6	13.0
TAP 335(*)010	A	3.3	0.5	6	10.0
TAP 475(*)010	A	4.7	0.5	6	8.0
TAP 685(*)010	B	6.8	0.5	6	6.0
TAP 106(*)010	C	10	0.8	8	5.0
TAP 156(*)010	D	15	1.2	8	3.7
TAP 226(*)010	E	22	1.7	8	2.7
TAP 336(*)010	F	33	2.6	8	2.1
TAP 476(*)010	G	47	3.7	8	1.7
TAP 686(*)010	H	68	5.4	8	1.3
TAP 107(*)010	K	100	8.0	10	1.0
TAP 157(*)010	N	150	12.0	10	0.8
TAP 227(*)010	P	220	17.6	10	0.6
TAP 337(*)010	R	330	20.0	10	0.5
16 volt @ 85°C (10 volt @ 125°C)					
TAP 155(*)016	A	1.5	0.5	4	10.0
TAP 225(*)016	A	2.2	0.5	6	8.0
TAP 335(*)016	A	3.3	0.5	6	6.0
TAP 475(*)016	B	4.7	0.6	6	5.0
TAP 685(*)016	C	6.8	0.8	6	4.0
TAP 106(*)016	D	10	1.2	8	3.2
TAP 156(*)016	E	15	1.9	8	2.5
TAP 226(*)016	F	22	2.8	8	2.0
TAP 336(*)016	F	33	4.2	8	1.6
TAP 476(*)016	J	47	6.0	8	1.3
TAP 686(*)016	L	68	8.7	8	1.0
TAP 107(*)016	N	100	12.8	10	0.8
TAP 157(*)016	N	150	19.2	10	0.6
TAP 227(*)016	R	220	20.0	10	0.5
20 volt @ 85°C (13 volt @ 125°C)					
TAP 105(*)020	A	1.0	0.5	4	10.0
TAP 155(*)020	A	1.5	0.5	4	9.0
TAP 225(*)020	A	2.2	0.5	6	7.0
TAP 335(*)020	B	3.3	0.5	6	5.5
TAP 475(*)020	C	4.7	0.7	6	4.5
TAP 685(*)020	D	6.8	1.0	6	3.6
TAP 106(*)020	E	10	1.6	8	2.9
TAP 156(*)020	F	15	2.4	8	2.3
TAP 226(*)020	H	22	3.5	8	1.8
TAP 336(*)020	J	33	5.2	8	1.4
TAP 476(*)020	K	47	7.5	8	1.2
TAP 686(*)020	N	68	10.8	8	0.9
TAP 107(*)020	N	100	16.0	10	0.6

AVX Part No.	Case Size	Capacitance (µF)	DCL (µA) Max.	DF % Max.	ESR Max. (Ω) @ 100 kHz
25 volt @ 85°C (16 volt @ 125°C)					
TAP 105(*)025	A	1.0	0.5	4	10.0
TAP 155(*)025	A	1.5	0.5	4	8.0
TAP 225(*)025	A	2.2	0.5	6	6.0
TAP 335(*)025	B	3.3	0.6	6	5.0
TAP 475(*)025	C	4.7	0.9	6	4.0
TAP 685(*)025	D	6.8	1.3	6	3.1
TAP 106(*)025	E	10	2.0	8	2.5
TAP 156(*)025	F	15	3.0	8	2.0
TAP 226(*)025	H	22	4.4	8	1.5
TAP 336(*)025	J	33	6.6	8	1.2
TAP 476(*)025	M	47	9.4	8	1.0
TAP 686(*)025	N	68	13.6	8	0.8
35 volt @ 85°C (23 volt @ 125°C)					
TAP 104(*)035	A	0.1	0.5	4	26.0
TAP 154(*)035	A	0.15	0.5	4	21.0
TAP 224(*)035	A	0.22	0.5	4	17.0
TAP 334(*)035	A	0.33	0.5	4	15.0
TAP 474(*)035	A	0.47	0.5	4	13.0
TAP 684(*)035	A	0.68	0.5	4	10.0
TAP 105(*)035	A	1.0	0.5	4	8.0
TAP 155(*)035	A	1.5	0.5	4	6.0
TAP 225(*)035	B	2.2	0.6	6	5.0
TAP 335(*)035	C	3.3	0.9	6	4.0
TAP 475(*)035	E	4.7	1.3	6	3.0
TAP 685(*)035	F	6.8	1.9	6	2.5
TAP 106(*)035	F	10	2.8	8	2.0
TAP 156(*)035	H	15	4.2	8	1.6
TAP 226(*)035	K	22	6.1	8	1.3
TAP 336(*)035	M	33	9.2	8	1.0
TAP 476(*)035	N	47	10.0	8	0.8
50 volt @ 85°C (33 volt @ 125°C)					
TAP 104(*)050	A	0.1	0.5	4	26.0
TAP 154(*)050	A	0.15	0.5	4	21.0
TAP 224(*)050	A	0.22	0.5	4	17.0
TAP 334(*)050	A	0.33	0.5	4	15.0
TAP 474(*)050	A	0.47	0.5	4	13.0
TAP 684(*)050	B	0.68	0.5	4	10.0
TAP 105(*)050	C	1.0	0.5	4	8.0
TAP 155(*)050	D	1.5	0.6	4	6.0
TAP 225(*)050	E	2.2	0.8	6	3.5
TAP 335(*)050	F	3.3	1.3	6	3.0
TAP 475(*)050	G	4.7	1.8	6	2.5
TAP 685(*)050	H	6.8	2.7	6	2.0
TAP 106(*)050	J	10	4.0	8	1.6
TAP 156(*)050	K	15	6.0	8	1.2
TAP 226(*)050	L	22	8.8	8	1.0

(*) Insert capacitance tolerance code; M for ±20%, K for ±10% and J for ±5%
 NOTE: Voltage ratings are minimum values. AVX reserves the right to supply higher voltage ratings in the same case size.

Dipped Radial Capacitors

TEP Series Tin-Lead (Sn/Pb) Finish Product



TEP is a Tin-Lead finish version of the conformally coated tantalum radial leaded capacitor (TAP). It is a professional grade device manufactured with a flame retardant coating and featuring low leakage current and impedance, very small physical sizes and exceptional temperature stability, available in bulk and T&R packaging for auto insertion. The wide range of Capacitance, working voltages and case sizes enables TEP to accommodate to almost any application.

Not RoHS Compliant

CASE DIMENSIONS:

millimeters (inches)

Wire Case	C, F, G, H H	B, S, D *H ₁	D
A	8.50 (0.335)	7.00 (0.276)	4.50 (0.177)
B	9.00 (0.354)	7.50 (0.295)	4.50 (0.177)
C	10.0 (0.394)	8.50 (0.335)	5.00 (0.197)
D	10.5 (0.413)	9.00 (0.354)	5.00 (0.197)
E	10.5 (0.413)	9.00 (0.354)	5.50 (0.217)
F	11.5 (0.453)	10.0 (0.394)	6.00 (0.236)
G	11.5 (0.453)	10.0 (0.394)	6.50 (0.256)
H	12.0 (0.472)	10.5 (0.413)	7.00 (0.276)
J	13.0 (0.512)	11.5 (0.453)	8.00 (0.315)
K	14.0 (0.551)		8.50 (0.335)
L	14.0 (0.551)		9.00 (0.354)
M	14.5 (0.571)		9.00 (0.354)
N	16.0 (0.630)		9.00 (0.354)
P	17.0 (0.669)		10.0 (0.394)
R	18.5 (0.728)		10.0 (0.394)

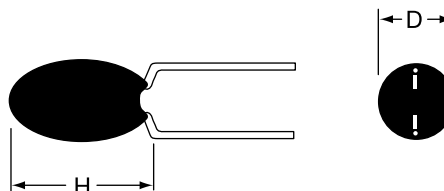

HOW TO ORDER

TEP

Type

106

Capacitance Code
pF code: 1st two digits represent significant figures, 3rd digit represents multiplier (number of zeros to follow)

M

Capacitance Tolerance
K = ±10%
M = ±20%
(For J = ±5% tolerance, please consult factory)

016

Rated DC Voltage

SCS

Suffix indicating wire form and packaging (see page 246)

Dipped Radial Capacitors

TEP Series

TECHNICAL SPECIFICATIONS

Technical Data:	All technical data relate to an ambient temperature of +25°C							
Capacitance Range:	0.10 μ F to 330 μ F							
Capacitance Tolerance:	\pm 10%; \pm 20% (\pm 5% consult your AVX representative for details)							
Rated Voltage DC (V_R)	\leq +85°C:	6.3	10	16	20	25	35	50
Category Voltage (V_C)	\leq +125°C:	4	6.3	10	13	16	23	33
Surge Voltage (V_S)	\leq +85°C:	8	13	20	26	33	46	65
Surge Voltage (V_S)	\leq +125°C:	5	9	12	16	21	28	40
Temperature Range:	-55°C to +125°C							
Dissipation Factor:	\leq 0.04 for C_R 0.1-1.5 μ F \leq 0.06 for C_R 2.2-6.8 μ F \leq 0.08 for C_R 10-68 μ F \leq 0.10 for C_R 100-330 μ F							
Reliability:	1% per 1000 hrs. at 85°C, V_R with 0.1 Ω /V series impedance, 60% confidence level.							

CAPACITANCE AND RATED VOLTAGE RANGE (LETTER DENOTES CASE SIZE)

Capacitance		Rated Voltage DC (V_R)						
μ F	Code	6.3V	10V	16V	20V	25V	35V	50V
0.10	104						A	A
0.15	154						A	A
0.22	224						A	A
0.33	334						A	A
0.47	474						A	A
0.68	684						A	B
1.0	105				A	A	A	C
1.5	155			A	A	A	A	D
2.2	225		A	A	A	A	B	E
3.3	335	A	A	A	B	B	C	F
4.7	475	A	A	B	C	C	E	G
6.8	685	A	B	C	D	D	F	H
10	106	B	C	D	E	E	F	J
15	156	C	D	E	F	F	H	K
22	226	D	E	F	H	H	K	L
33	336	E	F	F	J	J	M	
47	476	F	G	J	K	M	N	
68	686	G	H	L	N	N		
100	107	H	K	N	N			
150	157	K	N	N				
220	227	M	P	R				
330	337	P	R					

Values outside this standard range may be available on request.

AVX reserves the right to supply capacitors to a higher voltage rating, in the same case size, than that ordered.

MARKING

Polarity, capacitance, rated DC voltage, and an "A" (AVX logo) are laser marked on the capacitor body which is made of flame retardant gold epoxy resin with a limiting oxygen index in excess of 30 (ASTM-D-2863).

- Polarity \pm 20% = Standard (no marking)
- Capacitance \pm 10% = "K" on reverse side of unit
- Voltage \pm 5% = "J" on reverse side of unit
- AVX logo
- Tolerance code:

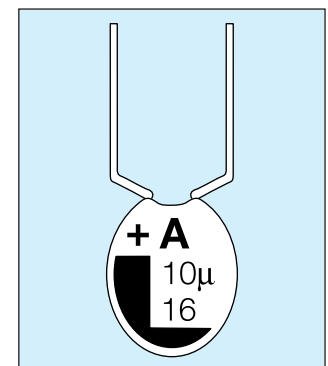

Dipped Radial Capacitors

TEP Series



RATINGS AND PART NUMBER REFERENCE

AVX Part No.	Case Size	Cap (µF)	DCL (µA) Max.	DF % Max.	ESR Max. (Ω) @100kHz
TEP335(*)006	A	3.3	0.5	6	13
TEP475(*)006	A	4.7	0.5	6	10
TEP685(*)006	A	6.8	0.5	6	8
TEP106(*)006	B	10	0.5	8	6
TEP156(*)006	C	15	0.8	8	5
TEP226(*)006	D	22	1.1	8	3.7
TEP336(*)006	E	33	1.7	8	3
TEP476(*)006	F	47	2.4	8	2
TEP686(*)006	G	68	3.4	8	1.8
TEP107(*)006	H	100	5	10	1.6
TEP157(*)006	K	150	7.6	10	0.9
TEP227(*)006	M	220	11	10	0.9
TEP337(*)006	P	330	16.6	10	0.7
TEP335(*)006	A	3.3	0.5	6	13
TEP225(*)010	A	2.2	0.5	6	13
TEP335(*)010	A	3.3	0.5	6	10
TEP475(*)010	A	4.7	0.5	6	8
TEP685(*)010	B	6.8	0.5	6	6
TEP106(*)010	C	10	0.8	8	5
TEP156(*)010	D	15	1.2	8	3.7
TEP226(*)010	E	22	1.7	8	2.7
TEP336(*)010	F	33	2.6	8	2.1
TEP476(*)010	G	47	3.7	8	1.7
TEP686(*)010	H	68	5.4	8	1.3
TEP107(*)010	K	100	8	10	1
TEP157(*)010	N	150	12	10	0.8
TEP227(*)010	P	220	17.6	10	0.6
TEP337(*)010	R	330	20	10	0.5
TEP155(*)016	A	1.5	0.5	4	10
TEP225(*)016	A	2.2	0.5	6	8
TEP335(*)016	A	3.3	0.5	6	6
TEP475(*)016	B	4.7	0.6	6	5
TEP685(*)016	C	6.8	0.8	6	4
TEP106(*)016	D	10	1.2	8	3.2
TEP156(*)016	E	15	1.9	8	2.5
TEP226(*)016	F	22	2.8	8	2
TEP336(*)016	F	33	4.2	8	1.6
TEP476(*)016	J	47	6	8	1.3
TEP686(*)016	L	68	8.7	8	1
TEP107(*)016	N	100	12.8	10	0.8
TEP157(*)016	N	150	19.2	10	0.6
TEP227(*)016	R	220	20	10	0.5
TEP105(*)020	A	1	0.5	4	10
TEP155(*)020	A	1.5	0.5	4	9
TEP225(*)020	A	2.2	0.5	6	7
TEP335(*)020	B	3.3	0.5	6	5.5
TEP475(*)020	C	4.7	0.7	6	4.5
TEP685(*)020	D	6.8	1	6	3.6
TEP106(*)020	E	10	1.6	8	2.9
TEP156(*)020	F	15	2.4	8	2.3

AVX Part No.	Case Size	Cap (µF)	DCL (µA) Max.	DF % Max.	ESR Max. (Ω) @100kHz
TEP226(*)020	H	22	3.5	8	1.8
TEP336(*)020	J	33	5.2	8	1.4
TEP476(*)020	K	47	7.5	8	1.2
TEP686(*)020	N	68	10.8	8	0.9
TEP107(*)020	N	100	16	10	0.6
TEP105(*)025	A	1	0.5	4	10
TEP155(*)025	A	1.5	0.5	4	8
TEP225(*)025	A	2.2	0.5	6	6
TEP335(*)025	B	3.3	0.6	6	5
TEP475(*)025	C	4.7	0.9	6	4
TEP685(*)025	D	6.8	1.3	6	3.1
TEP106(*)025	E	10	2	8	2.5
TEP156(*)025	F	15	3	8	2
TEP226(*)025	H	22	4.4	8	1.5
TEP336(*)025	J	33	6.6	8	1.2
TEP476(*)025	M	47	9.4	8	1
TEP686(*)025	N	68	13.6	8	0.8
TEP104(*)035	A	0.1	0.5	4	26
TEP154(*)035	A	0.15	0.5	4	21
TEP224(*)035	A	0.22	0.5	4	17
TEP334(*)035	A	0.33	0.5	4	15
TEP474(*)035	A	0.47	0.5	4	13
TEP684(*)035	A	0.68	0.5	4	10
TEP105(*)035	A	1	0.5	4	8
TEP155(*)035	A	1.5	0.5	4	6
TEP225(*)035	B	2.2	0.6	6	5
TEP335(*)035	C	3.3	0.9	6	4
TEP475(*)035	E	4.7	1.3	6	3
TEP685(*)035	F	6.8	1.9	6	2.5
TEP106(*)035	F	10	2.8	8	2
TEP156(*)035	H	15	4.2	8	1.6
TEP226(*)035	K	22	6.1	8	1.3
TEP336(*)035	M	33	9.2	8	1
TEP476(*)035	N	47	10	8	0.8
TEP104(*)050	A	0.1	0.5	4	26
TEP154(*)050	A	0.15	0.5	4	21
TEP224(*)050	A	0.22	0.5	4	17
TEP334(*)050	A	0.33	0.5	4	15
TEP474(*)050	A	0.47	0.5	4	13
TEP684(*)050	B	0.68	0.5	4	10
TEP105(*)050	C	1	0.5	4	8
TEP155(*)050	D	1.5	0.6	4	6
TEP225(*)050	E	2.2	0.8	6	3.5
TEP335(*)050	F	3.3	1.3	6	3
TEP475(*)050	G	4.7	1.8	6	2.5
TEP685(*)050	H	6.8	2.7	6	2
TEP106(*)050	J	10	4	8	1.6
TEP156(*)050	K	15	6	8	1.2
TEP226(*)050	L	22	8.8	8	1

Dipped Radial Capacitors

Tape and Reel Packaging

SOLID TANTALUM RESIN DIPPED TAP/TEP TAPE AND REEL PACKAGING FOR AUTOMATIC COMPONENT INSERTION

TAP/TEP types are all offered on radial tape, in reel or 'ammo' pack format for use on high speed radial automatic insertion equipment, or preforming machines.

The tape format is compatible with EIA 468A standard for component taping set out by major manufacturers of radial automatic insertion equipment.

TAP/TEP – available in three formats. See page 254 for dimensions.

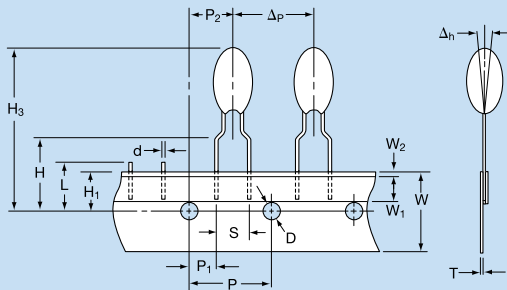

'B' wires for normal automatic insertion on 5mm pitch.

BRW suffix for reel

BRS suffix for 'ammo' pack

Available in case sizes A - J

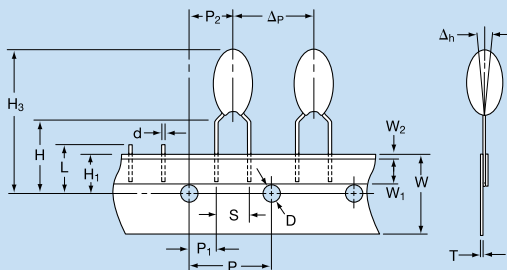

'C' wires for preforming.

CRW suffix for reel

CRS suffix for 'ammo' pack

Available in case sizes A - R

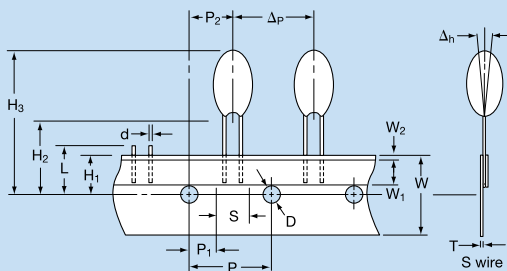

'S' and 'D' wire for special applications, automatic insertion on 2.5mm pitch.

SRW, DTW suffix for reel

SRS, DTS suffix for 'ammo' pack

Available in case sizes A - J

Dipped Radial Capacitors

Tape and Reel Packaging

SOLID TANTALUM RESIN DIPPED TAP/TEP

CASE DIMENSIONS:

Description	Code	Dimension millimeters (inches)
Feed hole pitch	P	12.7 ± 0.30 (0.500 ± 0.010)
Hole center to lead	P ₁	3.85 ± 0.70 (0.150 ± 0.030) to be measured at bottom of clench
		5.05 ± 1.00 (0.200 ± 0.040) for S wire
Hole center to component center	P ₂	6.35 ± 0.40 (0.250 ± 0.020)
Change in pitch	Δp	± 1.00 (± 0.040)
Lead diameter	d	0.50 ± 0.05 (0.020 ± 0.003)
Lead spacing	S	See wire form table
Component alignment	Δh	0 ± 2.00 (0 ± 0.080)
Feed hole diameter	D	4.00 ± 0.20 (0.150 ± 0.008)
Tape width	W	18.0 + 1.00 (0.700 + 0.040) - 0.50 - 0.020)
Hold down tape width	W ₁	6.00 (0.240) min.
Hold down tape position	W ₂	1.00 (0.040) max.
Lead wire clench height	H	16.0 ± 0.50 (0.630 ± 0.020)
		19.0 ± 1.00 (0.750 ± 0.040) on request
Hole position	H ₁	9.00 ± 0.50 (0.350 ± 0.020)
Base of component height	H ₂	18.0 (0.700) min. (S wire only)
Component height	H ₃	32.25 (1.300) max.
Length of snipped lead	L	11.0 (0.430) max.
Total tape thickness	T	0.70 ± 0.20 (0.030 ± 0.001)
		Carrying card 0.50 ± 0.10 (0.020 ± 0.005)

REEL CONFIGURATION AND DIMENSIONS:

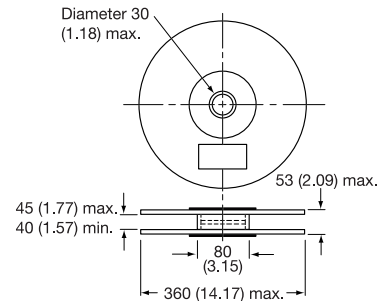

Manufactured from cardboard with plastic hub.

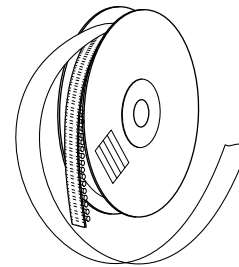

Holding tape outside. Positive terminal leading.

PACKAGING QUANTITIES

For Reels

Style	Case size	No. of pieces
TAP TEP	A	1500
	B, C, D	1250
	E, F	1000
	G, H, J	750
	K, L, M, N, P, R	500

For 'Ammo' pack

Style	Case size	No. of pieces
TAP TEP	A, B, C, D	3000
	E, F, G	2500
	H, J	2000
	K, L, M, N, P, R	1000

For bulk products

Style	Case size	No. of pieces
TAP TEP	A to H	1000
	J to L	500
	M to R	100

AMMO PACK DIMENSIONS

millimeters (inches) max.

Height 360 (14.17), width 360 (14.17), thickness 60 (2.36)

GENERAL NOTES

Resin dipped tantalum capacitors are only available taped in the range of case sizes and in the modular quantities by case size as indicated.

Packaging quantities on tape may vary by ±1%.

INTRODUCTION

Tantalum capacitors are manufactured from a powder of pure tantalum metal. OxiCap® - niobium oxide capacitor is made from niobium oxide NbO powder. The typical particle size is between 2 and 10 μm.

Figure below shows typical powders. Note the very great difference in particle size between the powder CVs/g.



4000μFV

20000μFV

50000μFV

Figure 1a. Tantalum powder

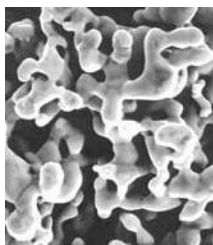

Figure 1b. Niobium Oxide powder

The powder is compressed under high pressure around a Tantalum or Niobium wire (known as the Riser Wire) to form a “pellet”. The riser wire is the anode connection to the capacitor. This is subsequently vacuum sintered at high temperature (typically 1200 - 1800°C) which produces a mechanically strong pellet and drives off any impurities within the powder.

During sintering the powder becomes a sponge like structure with all the particles interconnected in a huge lattice.

This structure is of high mechanical strength and density, but is also highly porous giving a large internal surface area (see Figure 2)

The larger the surface area the larger the capacitance. Thus high CV/g (capacitance voltage product per gram) powders, which have a low average particle size, are used for low voltage, high capacitance parts.

By choosing which powder and sinter temperature is used to produce each capacitance/voltage rating the surface area can be controlled.

The following example uses a 220μF 6V capacitor to illustrate the point.

$$C = \frac{\epsilon_0 \epsilon_r A}{d}$$

where ϵ_0 is the dielectric constant of free space (8.855 x 10⁻¹² Farads/m)

ϵ_r is the relative dielectric constant

= 27 for Tantalum Pentoxide

= 41 for Niobium Pentoxide

d is the dielectric thickness in meters

C is the capacitance in Farads

and A is the surface area in meters

Rearranging this equation gives:

$$A = \frac{C d}{\epsilon_0 \epsilon_r}$$

thus for a 220μF/6V capacitor the surface area is 346 square centimeters, or nearly a half times the size of this page.

The dielectric is then formed over all the Tantalum or niobium oxide surfaces by the electrochemical process of anodization. To activate this, the “pellet” is dipped into a very weak solution of phosphoric acid.

The dielectric thickness is controlled by the voltage applied during the forming process. Initially the power supply is kept in a constant current mode until the correct thickness of dielectric has been reached (that is the voltage reaches the ‘forming voltage’), it then switches to constant voltage mode and the current decays to close to zero.

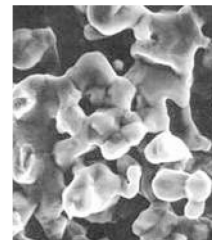
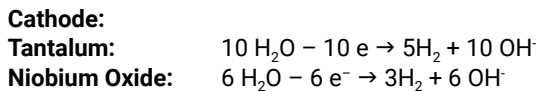
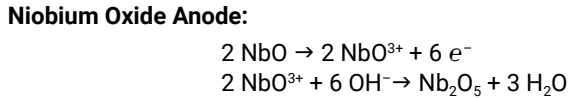
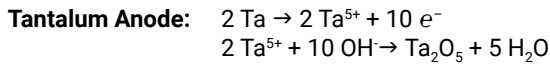

Figure 2. Sintered Anode

The chemical equations describing the process are as follows:



The oxide forms on the surface of the Tantalum or Niobium Oxide but it also grows into the material. For each unit of oxide two thirds grows out and one third grows in. It is for this reason that there is a limit on the maximum voltage rating of Tantalum & Niobium Oxide capacitors with present technology powders (see Figure 3).

The dielectric operates under high electrical stress. Consider a 220µF 6V part:

$$\begin{aligned} \text{Formation voltage} &= \text{Formation Ratio} \times \text{Working Voltage} \\ &= 3.5 \times 6 \\ &= 21 \text{ Volts} \end{aligned}$$

Tantalum:
 The pentoxide (Ta_2O_5) dielectric grows at a rate of 1.7×10^{-9} m/V

$$\begin{aligned} \text{Dielectric thickness (d)} &= 21 \times 1.7 \times 10^{-9} \\ &= 0.036 \text{ } \mu\text{m} \end{aligned}$$

$$\begin{aligned} \text{Electric Field strength} &= \text{Working Voltage} / d \\ &= 167 \text{ KV/mm} \end{aligned}$$

Niobium Oxide:
 The niobium oxide (Nb_2O_5) dielectric grows at a rate of 2.4×10^{-9} m/V

$$\begin{aligned} \text{Dielectric thickness (d)} &= 21 \times 2.4 \times 10^{-9} \\ &= 0.050 \text{ } \mu\text{m} \end{aligned}$$

$$\begin{aligned} \text{Electric Field strength} &= \text{Working Voltage} / d \\ &= 120 \text{ KV/mm} \end{aligned}$$

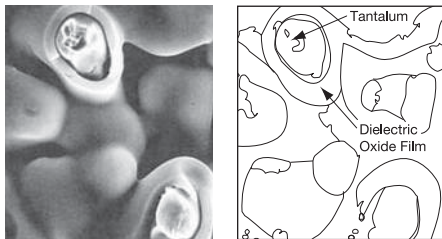
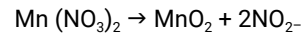

Figure 3. Dielectric layer

The next stage is the production of the cathode plate. This is achieved by pyrolysis of Manganese Nitrate into Manganese Dioxide.

The “pellet” is dipped into an aqueous solution of nitrate and then baked in an oven at approximately 250°C to produce the dioxide coat. The chemical equation is:



This process is repeated several times through varying specific densities of nitrate to build up a thick coat over all internal and external surfaces of the “pellet”, as shown in Figure 4.

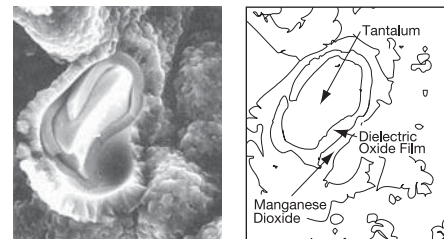

Figure 4. Manganese Dioxide Layer

The “pellet” is then dipped into graphite and silver to provide a good connection to the Manganese Dioxide cathode plate. Electrical contact is established by deposition of carbon onto the surface of the cathode. The carbon is then coated with a conductive material to facilitate connection to the cathode termination (see Figure 5). Packaging is carried out to meet individual specifications and customer requirements. This manufacturing technique is adhered to for the whole range of AVX Tantalum capacitors, which can be subdivided into four basic groups: Chip / Resin dipped / Rectangular boxed / Axial.

Further information on production of Tantalum Capacitors can be obtained from the technical paper “Basic Tantalum Technology”, by John Gill, available from your local AVX representative.

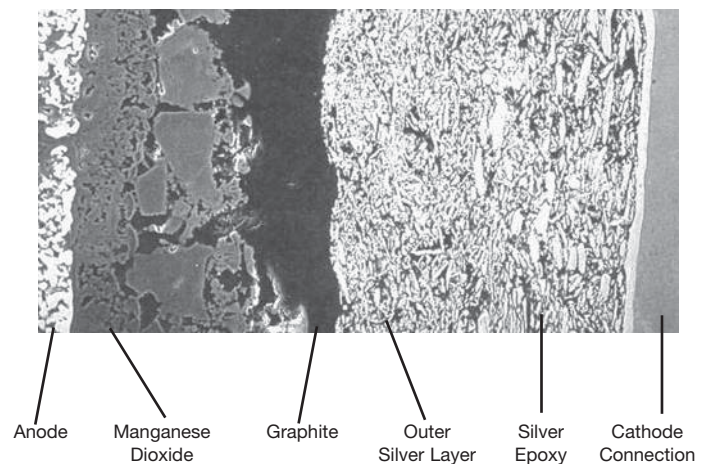

Figure 5. Cathode Termination

SECTION 1: ELECTRICAL CHARACTERISTICS AND EXPLANATION OF TERMS

1.1 CAPACITANCE

1.1.1 Rated capacitance (C_R).

This is the nominal rated capacitance. For tantalum and OxiCap® capacitors it is measured as the capacitance of the equivalent series circuit at 25°C using a measuring bridge supplied by a 0.5V rms 120Hz sinusoidal signal, free of harmonics with a bias of 2.2Vd.c.

1.1.2 Capacitance tolerance.

This is the permissible variation of the actual value of the capacitance from the rated value. For additional reading, please consult the AVX technical publication "Capacitance Tolerances for Solid Tantalum Capacitors".

1.1.3 Temperature dependence of capacitance.

The capacitance of a tantalum capacitor varies with temperature. This variation itself is dependent to a small extent on the rated voltage and capacitor size.

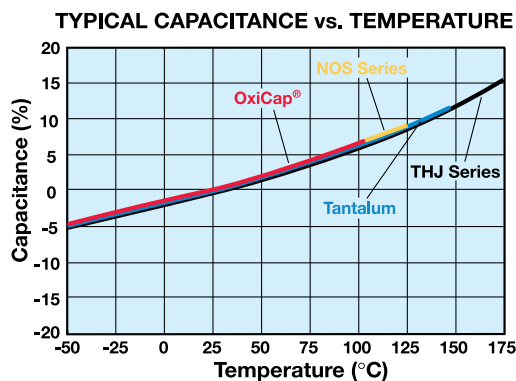

1.1.4 Frequency dependence of the capacitance.

The effective capacitance decreases as frequency increases. Beyond 100kHz the capacitance continues to drop until resonance is reached (typically between 0.5 - 5MHz depending on the rating). Beyond the resonant frequency the device becomes inductive.

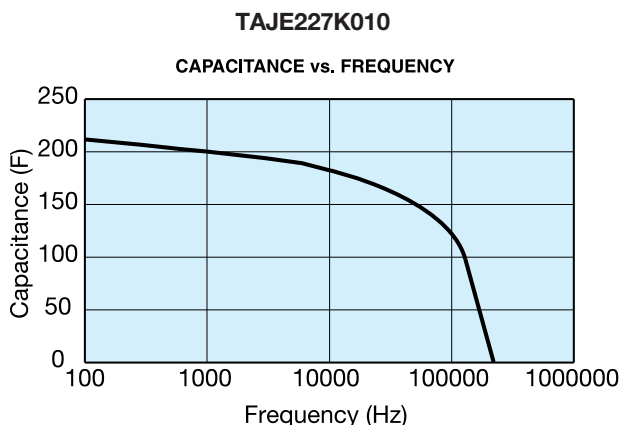

For individual part number please refer to SpiTan Software for frequency and temperature behavior found on AVX Corporation website.

1.2 VOLTAGE

1.2.1 Rated d.c. voltage (V_R).

This is the rated d.c. voltage for continuous operation up to 85°C (up to 40°C for TLJ, TLN, NLJ series).

Operating voltage consists of the sum of DC bias voltage and ripple peak voltage. The peak voltage should not exceed the category voltage. For recommended voltage (application) derating refer to figure 2c of the SECTION 3.

1.2.2 Category voltage (V_C).

This is the maximum voltage that may be applied continuously to a capacitor. It is equal to the rated voltage up to +85°C (up to 40°C for TLJ, TLN, NLJ series), beyond which it is subject to a linear derating, to 2/3 V_R at 125°C for tantalum and 2/3 V_R at 105°C for OxiCap®.

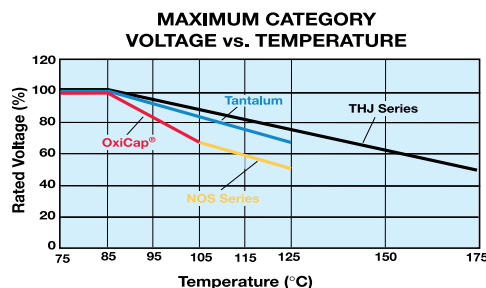

1.2.3 Surge voltage (V_S).

This is the highest voltage that may be applied to a capacitor for short periods of time in circuits with minimum series resistance of 330ohms (CECC states 1kΩ). The surge voltage may be applied up to 10 times in an hour for periods of up to 30 seconds at a time. The surge voltage must not be used as a parameter in the design of circuits in which, in the normal course of operation, the capacitor is periodically charged and discharged.

85°C Tantalum		125°C Tantalum*	
Rated Voltage V_R	Surge Voltage V_S	Category Voltage V_C	Surge Voltage V_S
2	2.7	1.3	1.7
2.5	3.3	1.7	2.2
3	3.9	2	2.6
4	5.2	2.7	3.4
5	6.5	3.3	4
6.3	8	4	5
10	13	7	8
16	20	10	13
20	26	13	16
25	32	17	20
35	46	23	28
50	65	33	40

85°C OxiCap®		105°C OxiCap®	
Rated Voltage V_R	Surge Voltage V_S	Category Voltage V_C	Surge Voltage V_S
1.8	2.3	1.2	1.6
2.5	3.3	1.7	2.2
4	5.2	2.7	3.4
6.3	8	4	5
10	13	7	8

*For THJ 175°C Category & Surge voltage see THJ section on pages 135-140.

1.2.4 Effect of surges

The solid Tantalum and OxiCap® capacitors have a limited ability to withstand voltage and current surges. This is in common with all other electrolytic capacitors and is due to the fact that they operate under very high electrical stress across the dielectric. For example a 6 volt tantalum capacitor has an Electrical Field of 167 kV/mm when operated at rated voltage. OxiCap® capacitors operate at electrical field significantly less than 167 kV/mm.

It is important to ensure that the voltage across the terminals of the capacitor never exceeds the specified surge voltage rating.

Solid tantalum capacitors and OxiCap® have a self healing ability provided by the Manganese Dioxide semiconducting layer used as the negative plate. However, this is limited in low impedance applications. In the case of low impedance circuits, the capacitor is likely to be stressed by current surges.

Derating the capacitor increases the reliability of the component. (See Figure 2b page 265). The “AVX Recommended Derating Table” (page 268) summarizes voltage rating for use on common voltage rails, in low impedance applications for both Tantalum and OxiCap® capacitors.

In circuits which undergo rapid charge or discharge a protective resistor of 1Ω/V is recommended. If this is impossible, a derating factor of up to 70% should be used on tantalum capacitors. OxiCap® capacitors can be used with derating of 20% minimum.

In such situations a higher voltage may be needed than is available as a single capacitor. A series combination should be used to increase the working voltage of the equivalent capacitor: For example, two 22μF 25V parts in series is equivalent to one 11μF 50V part. For further details refer to J.A. Gill's paper “Investigation into the Effects of Connecting Tantalum Capacitors in Series”, available from AVX offices worldwide.

NOTE:

While testing a circuit (e.g. at ICT or functional) it is likely that the capacitors will be subjected to large voltage and current transients, which will not be seen in normal use. These conditions should be borne in mind when considering the capacitor's rated voltage for use. These can be controlled by ensuring a correct test resistance is used.

1.2.5 Reverse voltage and Non-Polar operation.

The values quoted are the maximum levels of reverse voltage which should appear on the capacitors at any time. These limits are based on the assumption that the capacitors are polarized in the correct direction for the majority of their working life. They are intended to cover short term reversals of polarity such as those occurring during switching transients or during a minor portion of an impressed waveform. Continuous application of reverse voltage without normal polarization will result in a degradation of leakage current. In conditions under which continuous application of a reverse voltage could occur two similar capacitors should be used in a back-to-back configuration with the negative terminations connected together. Under most conditions this combination will have a capacitance

one half of the nominal capacitance of either capacitor. Under conditions of isolated pulses or during the first few cycles, the capacitance may approach the full nominal value. The reverse voltage ratings are designed to cover exceptional conditions of small level excursions into incorrect polarity. The values quoted are not intended to cover continuous reverse operation.

The peak reverse voltage applied to the capacitor must not exceed:

10% of the rated d.c. working voltage to a maximum of 1.0v at 25°C

3% of the rated d.c. working voltage to a maximum of 0.5v at 85°C

1% of the rated d.c. working voltage to a maximum of 0.1v at 125°C (0.1v at 150°C THJ Series)

Note: Capacitance and DF values of OxiCap® may exceed specification limits under these conditions.

LEAKAGE CURRENT vs. BIAS VOLTAGE

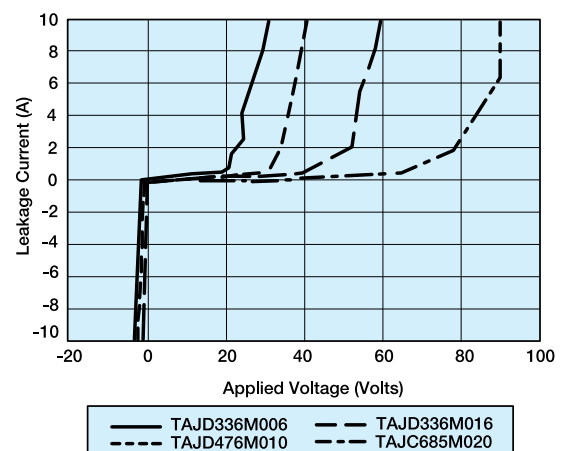

1.2.6 Superimposed A.C. Voltage (Vr.m.s.) - Ripple Voltage.

This is the maximum r.m.s. alternating voltage; superimposed on a d.c. voltage, that may be applied to a capacitor. The sum of the d.c. voltage and peak value of the superimposed a.c. voltage must not exceed the category voltage, v.c.

Full details are given in Section 2.

1.2.7 Forming voltage.

This is the voltage at which the anode oxide is formed. The thickness of this oxide layer is proportional to the formation voltage for a capacitor and is a factor in setting the rated voltage.

1.3 DISSIPATION FACTOR AND TANGENT OF LOSS ANGLE (TAN δ)

1.3.1 Dissipation factor (D.F.).

Dissipation factor is the measurement of the tangent of the loss angle (\tan) expressed as a percentage. The measurement of DF is carried out using a measuring bridge that supplies a 0.5V rms 120Hz sinusoidal signal, free of harmonics with a bias of 2.2Vdc. The value of DF is temperature and frequency dependent.

Note: For surface mounted products the maximum allowed DF values are indicated in the ratings table and it is important to note that these are the limits met by the component AFTER soldering onto the substrate.

1.3.2 Tangent of Loss Angle ($\tan \delta$).

This is a measurement of the energy loss in the capacitor. It is expressed, as \tan and is the power loss of the capacitor divided by its reactive power at a sinusoidal voltage of specified frequency. Terms also used are power factor, loss factor and dielectric loss. $\cos(90 - \delta)$ is the true power factor. The measurement of $\tan \delta$ is carried out using a measuring bridge that supplies a 0.5V rms 120Hz sinusoidal signal, free of harmonics with a bias of 2.2Vdc.

1.3.3 Frequency dependence of Dissipation Factor.

Dissipation Factor increases with frequency as shown in the typical curves that are for tantalum and OxiCap® capacitors identical:

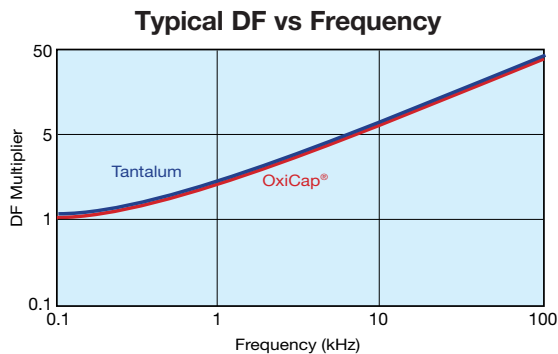

1.3.4 Temperature dependence of Dissipation Factor.

Dissipation factor varies with temperature as the typical curves show. These plots are identical for both Tantalum and OxiCap® capacitors. For maximum limits please refer to ratings tables.

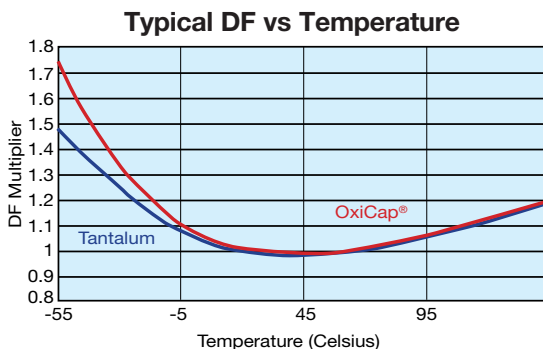

1.4 IMPEDANCE, (Z) AND EQUIVALENT SERIES RESISTANCE (ESR)

This is the ratio of voltage to current at a specified frequency. Three factors contribute to the impedance of a Tantalum capacitor; the resistance of the semiconductor layer; the capacitance value and the inductance of the electrodes and leads.

At high frequencies the inductance of the leads becomes a limiting factor. The temperature and frequency behavior of these three factors of impedance determine the behavior of the impedance Z. The impedance is measured at 25°C and 100kHz

1.4.2 Equivalent Series Resistance, ESR.

Resistance losses occur in all practical forms of capacitors. These are made up from several different mechanisms, including resistance in components and contacts, viscous forces within the dielectric and defects producing bypass current paths. To express the effect of these losses they are considered as the ESR of the capacitor. The ESR is frequency dependent and can be found by using the relationship;

$$ESR = \frac{\tan \delta}{2\pi fC}$$

Where f is the frequency in Hz, and C is the capacitance in farads. The ESR is measured at 25°C and 100kHz.

ESR is one of the contributing factors to impedance, and at high frequencies (100kHz and above) it becomes the dominant factor. Thus ESR and impedance become almost identical, impedance being only marginally higher.

1.4.3 Frequency dependence of Impedance and ESR.

ESR and Impedance both increase with decreasing frequency. At lower frequencies the values diverge as the extra contributions to impedance (due to the reactance of the capacitor) become more significant. Beyond 1MHz (and beyond the resonant point of the capacitor) impedance again increases due to the inductance of the capacitor. Typical ESR and Impedance values are similar for both tantalum and niobium oxide materials and thus the same charts are valid for both for Tantalum and OxiCap® capacitors.

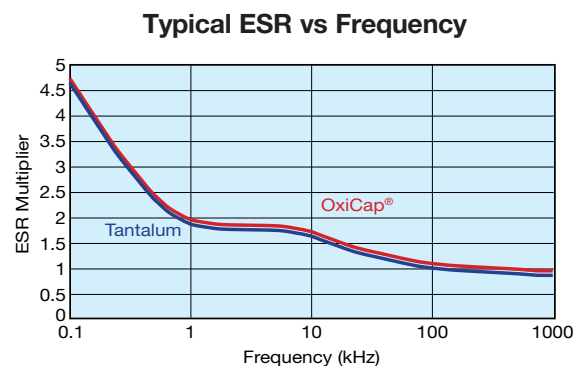

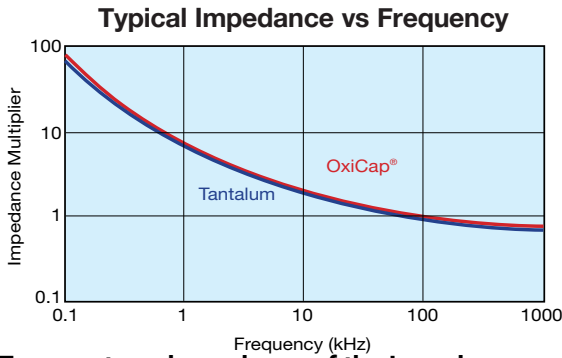

1.4.4 Temperature dependence of the Impedance and ESR.

At 100kHz, impedance and ESR behave identically and decrease with increasing temperature as the typical curves show.

Typical 100kHz ESR vs Temperature

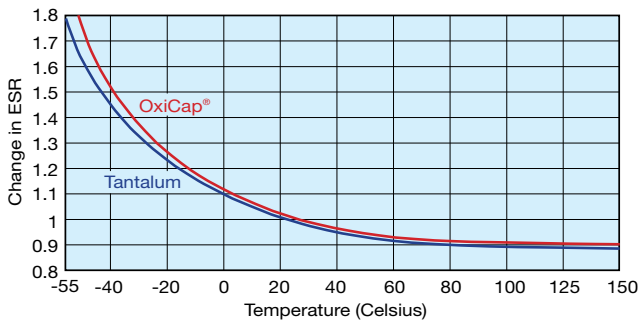

1.5 D.C. LEAKAGE CURRENT

1.5.1 Leakage current.

The leakage current is dependent on the voltage applied, the elapsed time since the voltage was applied and the component temperature. It is measured at +20°C with the rated voltage applied. A protective resistance of 1000Ω is connected in series with the capacitor in the measuring circuit. Three to five minutes after application of the rated voltage the leakage current must not exceed the maximum values indicated in the ratings table. Leakage current is referenced as DCL (for Direct Current Leakage). The default maximum limit for DCL Current is given by $DCL = 0.01CV$, where DCL is in microamperes, and C is the capacitance rating in microfarads, and V is the voltage rating in volts. DCL of tantalum capacitors vary within arrange of 0.01 - 0.1CV or 0.5μA (whichever is the greater). And 0.02 - 0.1CV or 1.0μA (whichever is the greater) for OxiCap® capacitors.

Reforming of Tantalum or OxiCap® capacitors is unnecessary even after prolonged storage periods without the application of voltage.

1.5.2 Temperature dependence of the leakage current.

The leakage current increases with higher temperatures; typical values are shown in the graph. For operation between 85°C and 125°C, the maximum working voltage must be derated and can be found from the following formula.

$$V_{max} = \left(1 - \frac{T - 85}{125}\right) \times V_R$$

where T is the required operating temperature.

LEAKAGE CURRENT vs. TEMPERATURE

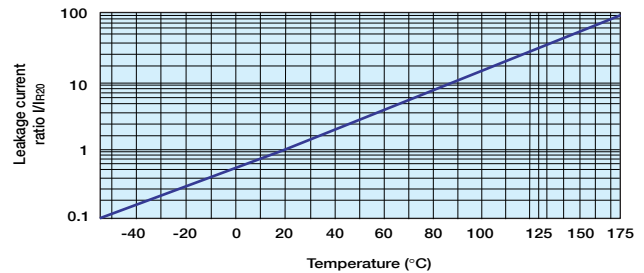

1.5.3 Voltage dependence of the leakage current.

The leakage current drops rapidly below the value corresponding to the rated voltage V_R when reduced voltages are applied.

The effect of voltage derating on the leakage current is shown in the graph. This will also give a significant increase in the reliability for any application. See Section 3.1 (page 265) for details.

LEAKAGE CURRENT vs. RATED VOLTAGE

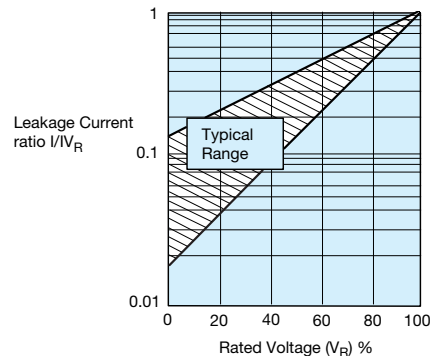

For input condition of fixed application voltage and including median curve of the Leakage current vs. Rated voltage graph displayed above we can evaluate following curve.

LEAKAGE CURRENT MULTIPLIER vs. VOLTAGE DERATING for FIXED APPLICATION VOLTAGE V_A

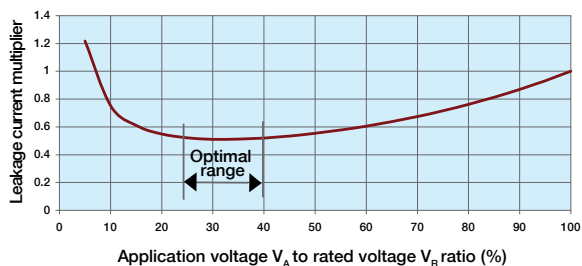

We can identify the range of V_A/V_R (derating) values with minimum actual DCL as the “optimal” range. Therefore the minimum DCL is obtained when capacitor is used at 25 to 40 % of rated voltage - when the rated voltage of the capacitor is 2.5 to 4 times higher than actual application voltage.

For additional information on Leakage Current, please consult the AVX technical publication “Analysis of Solid Tantalum Capacitor Leakage Current” by R. W. Franklin.

1.5.4 Ripple current.

The maximum ripple current allowed is derived from the power dissipation limits for a given temperature rise above ambient temperature (please refer to Section 2, pages 262-263).

1.6 SELF INDUCTANCE (ESL)

The self-inductance value (ESL) can be important for resonance frequency evaluation. See figure below typical ESL values per case size.

TAJ/TMJ/TPS/TRJ/THJ/TLJ/TCJ/TCO/TCQ/ NLJ/NOJ/NOS

Case Size	Typical Self Inductance value (nH)	Case Size	Typical Self Inductance value (nH)	Case Size	Typical Self Inductance value (nH)
A	1.8	H	1.8	U	2.4
B	1.8	K	1.8	V	2.4
C	2.2	N	1.4	W	2.2
D	2.4	P	1.4	X	2.4
E	2.5	R	1.4	Y	2.4
F	2.2	S	1.8	5	2.4
G	1.8	T	1.8		

TAC/TLC/TPC

Case Size	Typical Self Inductance value (nH)
A	1.5
B	1.6
D	1.4
E	1.0
H	1.4
I	1.3
J	1.2
K	1.1
L	1.2
M	1.3
R	1.4
T	1.6
U	1.3
V	1.5
Z	1.1

TCM/TPM TRM/NOM

Case Size	Typical Self Inductance value (nH)
D	1.0
E	2.5
U	2.4
V	2.4
Y	1.0

TLN/TCN/J-CAP™

Case Size	Typical Self Inductance value (nH)
K	1.0
L	1.0
M	1.3
N	1.3
O	1.0
S	1.0
T	1.0
X	1.8
Z	1.8
3	2.0
4	2.2
6	2.5
8	2.2

SECTION 2: A.C. OPERATION, RIPPLE VOLTAGE AND RIPPLE CURRENT

2.1 RIPPLE RATINGS (A.C.)

In an a.c. application heat is generated within the capacitor by both the a.c. component of the signal (which will depend upon the signal form, amplitude and frequency), and by the d.c. leakage. For practical purposes the second factor is insignificant. The actual power dissipated in the capacitor is calculated using the formula:

$$P = I^2 R$$

and rearranged to $I = \text{SQRT}(P/R)$ (Eq. 1)

where I = rms ripple current, amperes
 R = equivalent series resistance, ohms
 U = rms ripple voltage, volts
 P = power dissipated, watts
 Z = impedance, ohms, at frequency under consideration

Maximum a.c. ripple voltage (U_{max}).

From the Ohms' law equation:

$$U_{\text{max}} = IR \text{(Eq. 2)}$$

Where P is the maximum permissible power dissipated as listed for the product under consideration (see tables).

However care must be taken to ensure that:

1. The d.c. working voltage of the capacitor must not be exceeded by the sum of the positive peak of the applied a.c. voltage and the d.c. bias voltage.
2. The sum of the applied d.c. bias voltage and the negative peak of the a.c. voltage must not allow a voltage reversal in excess of the "Reverse Voltage".

Historical ripple calculations.

Previous ripple current and voltage values were calculated using an empirically derived power dissipation required to give a 10°C (30°C for polymer) rise of the capacitors body temperature from room temperature, usually in free air. These values are shown in Table I. Equation 1 then allows the maximum ripple current to be established, and Equation 2, the maximum ripple voltage. But as has been shown in the AVX article on thermal management by I. Salisbury, the thermal conductivity of a Tantalum chip capacitor varies considerably depending upon how it is mounted.

Table I: Power Dissipation Ratings (In Free Air)

TAJ/TMJ/TPS/TPM/TRJ/TRM/THJ/TLJ/TLN/TCJ/TCM/TCN/J-CAP™/TCO/TCQ/NLJ/NOJ/NOS/NOM Series Molded Chip

Case Size	Max. power dissipation (W)						
	Tantalum			Polymer		OxiCap®	
	TAJ/TMJ/TPS TRJ/THJ TLJ	TLN	TPM TRM	TCJ TCN J-CAP™ TCO TCQ	TCM	NLJ NOJ NOS	NOM
A	0.075	—	—	0.100	—	0.090	—
B	0.085	—	—	0.125	—	0.102	—
C	0.110	—	—	0.175	—	0.132	—
D	0.150	—	0.255	0.225	—	0.180	—
E	0.165	—	0.270	0.250	0.410	0.198	0.324
F	0.100	—	—	0.150	—	0.120	—
G	0.070	0.060	—	0.100	—	0.084	—
H	0.080	0.070	—	0.100	—	0.096	—
K	0.065	0.055	—	0.090	—	0.078	—
L	0.070	0.060	—	0.095	—	0.084	—
M	—	0.040	—	0.080	—	—	—
N	0.050	0.040	—	0.080	—	—	—
O	—	—	—	0.065	—	—	—
P	0.060	—	—	0.090	—	0.072	—
R	0.055	—	—	0.085	—	0.066	—
S	0.065	0.055	—	0.095	—	0.078	—
T	0.080	0.070	—	0.100	—	0.096	—
U	0.165	—	0.295	0.380	—	—	—
V	0.250	—	0.285	0.360	0.420	0.300	—
W	0.090	—	—	0.130	—	0.108	—
X	0.100	—	—	0.175	—	0.120	—
Y	0.125	0.115	0.210	0.185	—	0.150	—
Z	—	—	—	0.175	—	—	—
3	—	—	—	0.145	—	—	—
4	—	0.165	—	0.190	—	—	—
5	—	—	—	0.240	—	—	—
6	—	0.230	—	—	—	—	—
8	—	—	—	0.190	—	—	—

TACmicrochip® Series

Case Size	Max. power dissipation (W)
A	0.040
B	0.040
D	0.035
E	0.010
H	0.040
I	0.035
J	0.020
K	0.015
L	0.025
M	0.030
Q	0.040
R	0.045
T	0.040
U	0.035
V	0.035
X	0.040
Z	0.020

NLJ/NOJ/NOS/NOM

Temperature correction factor for ripple current	
Temp. °C	Factor
+25	1.00
+55	0.95
+85	0.90
+105	0.40
+125 (NOS,NOM)	0.40

TAJ/TPS/TPM/TRJ/TRM/THJ/TLJ/TLN

Temp °C	Correction Factor for ripple current	Correction Factor for Power Dissipation	Max. Temperature rise °C
up to 25°C	1.00	1.00	10
+55	0.95	0.90	9
+85	0.90	0.81	8.1
+105	0.65	0.42	4.2
+115	0.49	0.24	2.4
+125	0.40	0.16	1.6
+175 (THJ)	0.20	0.04	0.4
+200 (THJ)	0.10	0.01	0.1

TCJ/TCM/TCN/J-CAP™/TCO/TCQ

Temp °C	Correction Factor for ripple current	Correction Factor for Power Dissipation	Max. Temperature rise °C
up to 45°C	1.00	1.00	30
+85	0.70	0.49	15
+105	0.45	0.20	6
+125	0.25	0.06	1.8

A piece of equipment was designed which would pass sine and square wave currents of varying amplitudes through a biased capacitor. The temperature rise seen on the body of the capacitor was then measured using an infra-red probe. This ensured that there was no heat loss through any thermocouple attached to the capacitor's surface.

Results for the C, D and E case sizes

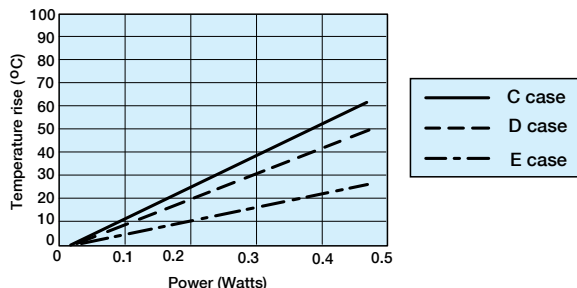

Several capacitors were tested and the combined results are shown above. All these capacitors were measured on FR4 board, with no other heat sinking. The ripple was supplied at various frequencies from 1kHz to 1MHz.

As can be seen in the figure above, the average P_{max} value for the C case capacitors was 0.11 Watts. This is the same as that quoted in Table I.

The D case capacitors gave an average P_{max} value 0.125 Watts. This is lower than the value quoted in the Table I by 0.025 Watts. The E case capacitors gave an average P_{max} of 0.200 Watts that was much higher than the 0.165 Watts from Table I.

If a typical capacitor's ESR with frequency is considered, e.g. figure below, it can be seen that there is variation. Thus for a set ripple current, the amount of power to be dissipated by the capacitor will vary with frequency. This is clearly shown in figure in top of next column, which shows that the surface temperature of the unit raises less for a given value of ripple current at 1MHz than at 100kHz.

The graph below shows a typical ESR variation with frequency. Typical ripple current versus temperature rise for 100kHz and 1MHz sine wave inputs.

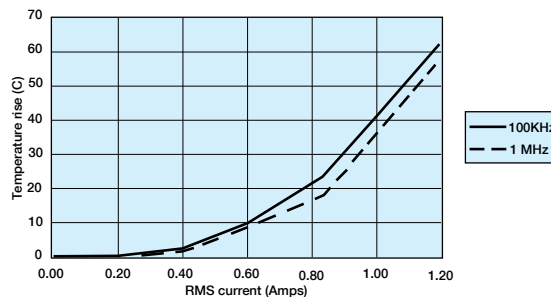
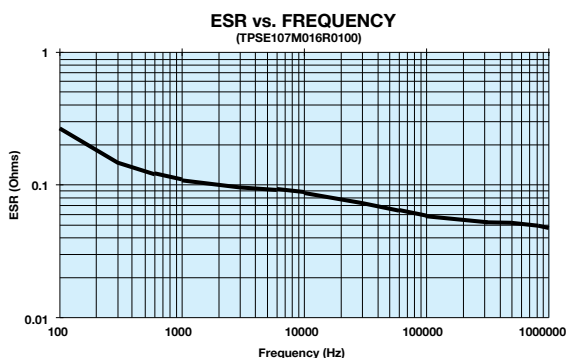

If I^2R is then plotted it can be seen that the two lines are in fact coincident, as shown in figure below.

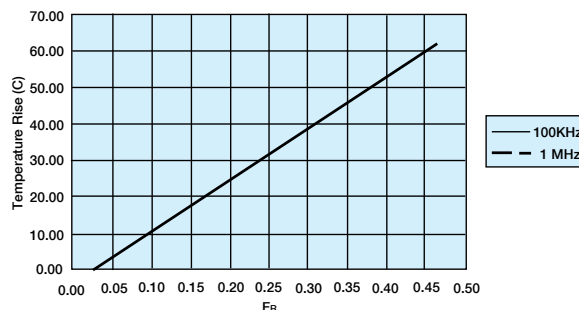

Example

A Tantalum capacitor is being used in a filtering application, where it will be required to handle a 2 Amp peak-to-peak, 200kHz square wave current.

A square wave is the sum of an infinite series of sine waves at all the odd harmonics of the square waves fundamental frequency. The equation which relates is:

$$I_{square} = I_{pk} \sin(2\pi f) + I_{pk} \sin(6\pi f) + I_{pk} \sin(10\pi f) + I_{pk} \sin(14\pi f) + \dots$$

Thus the special components are:

Frequency	Peak-to-peak current (Amps)	RMS current (Amps)
200 KHz	2.000	0.707
600 KHz	0.667	0.236
1 MHz	0.400	0.141
1.4 MHz	0.286	0.101

Let us assume the capacitor is a TAJD686M006

Typical ESR measurements would yield.

Frequency	Typical ESR (Ohms)	Power (Watts) $I_{rms}^2 \times ESR$
200 KHz	0.120	0.060
600 KHz	0.115	0.006
1 MHz	0.090	0.002
1.4 MHz	0.100	0.001

Thus the total power dissipation would be 0.069 Watts.

From the D case results shown in figure top of previous column, it can be seen that this power would cause the capacitors surface temperature to rise by about 5°C. For additional information, please refer to the AVX technical publication "Ripple Rating of Tantalum Chip Capacitors" by R.W. Franklin.

2.2 OXICAP® RIPPLE RATING

OxiCap® capacitors showing 20% higher power dissipation allowed compared to tantalum capacitors as a result of twice higher specific heat of niobium oxide compared to Tantalum powders. (Specific heat is related to energy necessary to heat a defined volume of material to

a specified temperature.)

2.3 THERMAL MANAGEMENT

The heat generated inside a tantalum capacitor in a.c. operation comes from the power dissipation due to ripple current. It is equal to I^2R , where I is the rms value of the current at a given frequency, and R is the ESR at the same frequency with an additional contribution due to the leakage current. The heat will be transferred from the outer surface by conduction. How efficiently it is transferred from this point is dependent on the thermal management of the board.

The power dissipation ratings given in Section 2.1 (page 236) are based on free-air calculations. These ratings can be approached if efficient heat sinking and/or forced cooling is used.

In practice, in a high density assembly with no specific thermal

management, the power dissipation required to give a 10°C (30°C for polymer) rise above ambient may be up to a factor of 10 less. In these cases, the actual capacitor temperature should be established (either by thermocouple probe or infra-red scanner) and if it is seen to be above this limit it may be necessary to specify a lower ESR part or a higher voltage rating.

Please contact application engineering for details or contact the AVX technical publication entitled "Thermal Management of Surface Mounted Tantalum Capacitors" by Ian Salisbury.

Thermal Dissipation from the Mounted Chip

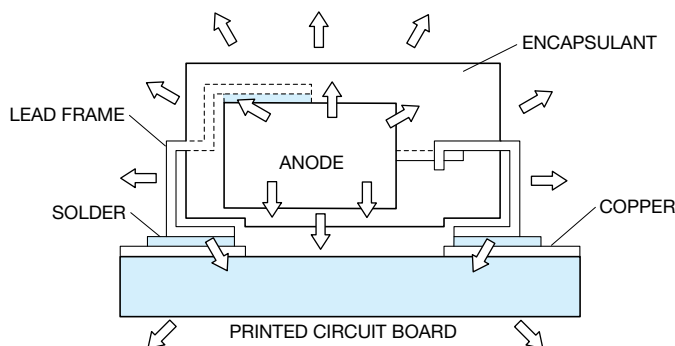

Thermal Impedance Graph with Ripple Current

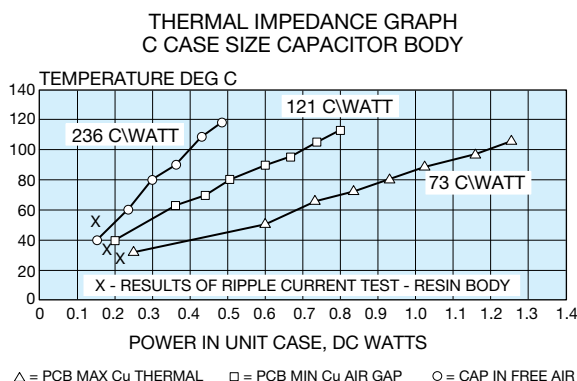

SECTION 3: RELIABILITY AND CALCULATION OF FAILURE RATE

3.1 STEADY-STATE

Both Tantalum and Niobium Oxide dielectric have essentially no wear out mechanism and in certain circumstances is capable of limited self healing. However, random failures can occur in operation. The failure rate of Tantalum capacitors will decrease with time and not increase as with other electrolytic capacitors and other electronic components.

Figure 1. Tantalum and OxiCap® Reliability Curve

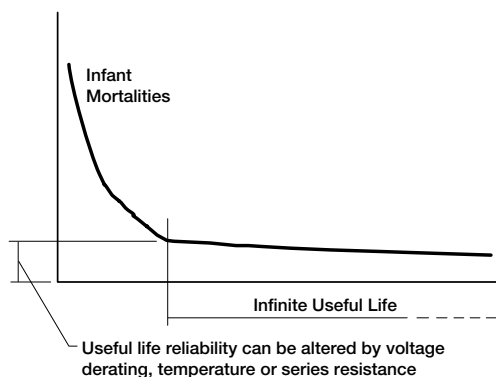

The useful life reliability of the Tantalum and OxiCap® capacitors in steady-state is affected by three factors. The equation from which the failure rate can be calculated is:

$$F = F_V \times F_T \times F_R \times F_B$$

where F_V is a correction factor due to operating voltage/voltage derating

F_T is a correction factor due to operating temperature

F_R is a correction factor due to circuit series resistance

F_B is the basic failure rate level

Base failure rate.

Standard Tantalum conforms to Level M reliability (i.e. 1%/1000 hrs) or better at rated voltage, 85°C and 0.1Ω/volt circuit impedance.

$F_B = 1.0\% / 1000$ hours for TAJ, TPS, TPM, TCJ, TCO, TCQ, TCM, TCN, J-CAP™, TAC

0.5% / 1000 hours for TMJ, TRJ, TRM, THJ & NOJ

0.2% / 1000 hours for NOS and NOM

TLJ, TLN, TLC and NLJ series of tantalum capacitors are defined at 0.5 x rated voltage at 85°C due to the temperature derating.

$F_B = 0.2\% / 1000$ hours at 85°C and $0.5 \times V_R$ with 0.1Ω/V series impedance with 60% confidence level.

Operating voltage/voltage derating.

If a capacitor with a higher voltage rating than the maximum line voltage is used, then the operating reliability will be improved. This is known as voltage derating.

The graph, Figure 2a, shows the relationship between voltage derating (the ratio between applied and rated voltage) and the failure rate. The graph gives the correction factor F_V for any operating voltage.

Figure 2a. Correction factor to failure rate F_V for voltage derating of a typical component (60% con. level).

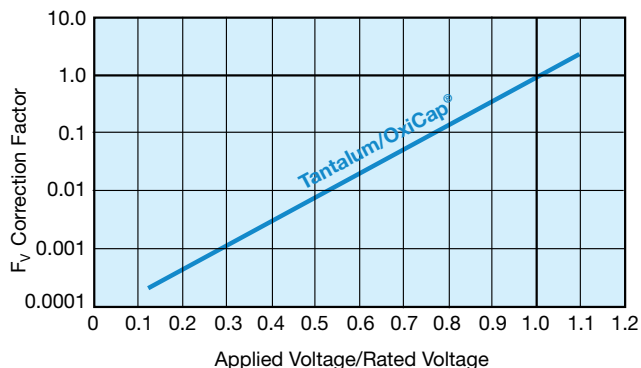

Figure 2b. Gives our recommendation for voltage derating for tantalum capacitors to be used in typical applications.

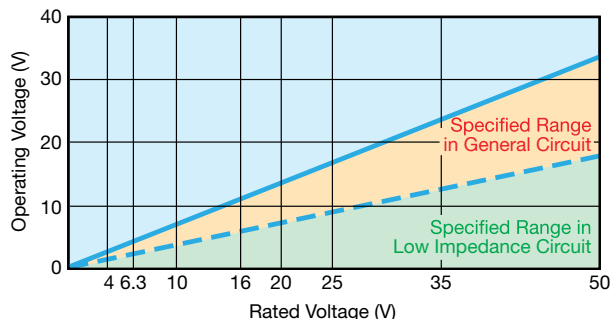
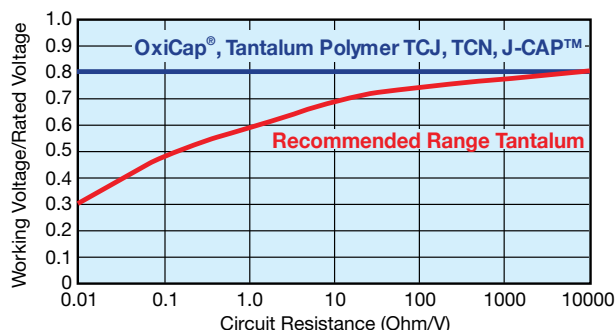

Figure 2c. Gives voltage derating recommendations for tantalum capacitors as a function of circuit impedance.



Operating Temperature.

If the operating temperature is below the rated temperature for the capacitor then the operating reliability will be improved as shown in Figure 3. This graph gives a correction factor F_T for any temperature of operation.

Figure 3: Correction factor to failure rate F_R for ambient temperature T for typical component (60% con. level).

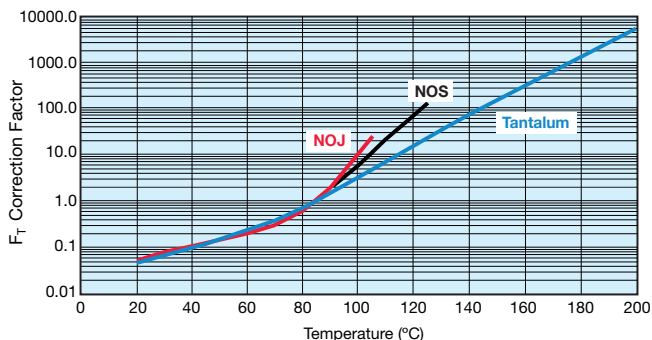

Circuit Impedance.

All solid Tantalum and/or niobium oxide capacitors require current limiting resistance to protect the dielectric from surges. A series resistor is recommended for this purpose. A lower circuit impedance may cause an increase in failure rate, especially at temperatures higher than 20°C. An inductive low impedance circuit may apply voltage surges to the capacitor and similarly a non-inductive circuit may apply current surges to the capacitor, causing localized over-heating and failure. The recommended impedance is 1 Ω per volt. Where this is not feasible, equivalent voltage derating should be used (See MIL HANDBOOK 217). The graph, Figure 4, shows the correction factor, FR, for increasing series resistance.

Figure 4. Correction factor to failure rate F_R for series resistance R on basic failure rate F_B for a typical component (60% con. level).

Circuit resistance ohms/volt	F_R
3.0	0.07
2.0	0.1
1.0	0.2
0.8	0.3
0.6	0.4
0.4	0.6
0.2	0.8
0.1	1.0

For circuit impedances below 0.1 ohms per volt, or for any mission critical application, circuit protection should be considered. An ideal solution would be to employ an AVX SMT thin-film fuse in series.

Example calculation.

Consider a 12 volt power line. The designer needs about 10 μ F of capacitance to act as a decoupling capacitor near a video bandwidth amplifier. Thus the circuit impedance will be limited only by the output impedance of the board's power unit and the track resistance. Let us assume it to be about 2 Ohms minimum, i.e. 0.167 Ohms/Volt. The operating temperature range is -25°C to +85°C.

If a 10 μ F 16 Volt capacitor was designed in the operating failure rate would be as follows.

- $F_T = 1.0 @ 85^\circ\text{C}$
- $F_R = 0.85 @ 0.167 \text{ Ohms/Volt}$
- $F_V = 0.08 @ \text{applied voltage/rated voltage} = 75\%$
- $F_B = 1\%/1000 \text{ hours, basic failure rate level}$

Thus $F = 1.0 \times 0.85 \times 0.08 \times 1 = 0.068\%/1000 \text{ Hours}$ If the capacitor was changed for a 20 volt capacitor, the operating failure rate will change as shown.

$$F_V = 0.018 @ \text{applied voltage/rated voltage} = 60\%$$

$$F = 1.0 \times 0.85 \times 0.018 \times 1 = 0.0153\%/1000 \text{ Hours}$$

3.2 Dynamic.

As stated in Section 1.2.4 (page 258), the solid capacitor has a limited ability to withstand voltage and current surges. Such current surges can cause a capacitor to fail. The expected failure rate cannot be calculated by a simple formula as in the case of steady-state reliability. The two parameters under the control of the circuit design engineer known to reduce the incidence of failures are derating and series resistance.

The table below summarizes the results of trials carried out at AVX with a piece of equipment, which has very low series resistance with no voltage derating applied. That is if the capacitor was tested at its rated voltage. It has been tested on tantalum capacitors, however the conclusions are valid for both tantalum and OxiCap[®] capacitors.

Results of production scale derating experiment

Capacitance and Voltage	Number of units tested	50% derating applied	No derating applied
47 μ F 16V	1,547,587	0.03%	1.1%
100 μ F 10V	632,876	0.01%	0.5%
22 μ F 25V	2,256,258	0.05%	0.3%

As can clearly be seen from the results of this experiment, the more derating applied by the user, the less likely the probability of a surge failure occurring.

It must be remembered that these results were derived from a highly accelerated surge test machine, and failure rates in the low ppm are more likely with the end customer.

A commonly held misconception is that the leakage current of a Tantalum capacitor can predict the number of failures which will be seen on a surge screen. This can be disproved by the results of an experiment carried out at AVX on 47 μ F

10V surface mount capacitors with different leakage currents. The results are summarized in the table below.

Leakage current vs number of surge failures.

Again, it must be remembered that these results were derived from a highly accelerated surge test machine, and failure rates in the low ppm are more likely with the end customer.

	Number tested	Number failed surge
Standard leakage range 0.1µA to 1µA	10,000	25
Over Catalog limit 5µA to 50µA	10,000	26
Classified Short Circuit 50µA to 500µA	10,000	25

OxiCap[®] capacitor is less sensitive to an overloading stress compared to Tantalum and so a 20% minimum derating is recommended. It may be necessary in extreme low impedance circuits of high transient or 'switch-on' currents to derate the voltage further. Hence in general a lower voltage OxiCap[®] part number can be placed on a higher rail voltage compared to the tantalum capacitor - see table below.

AVX recommended derating table.

Voltage Rail (V)	Rated Voltage of Cap (V)	
	Tantalum	OxiCap [®]
3.3	6.3	4
5	10	6.3
8	16	10
10	20	-
12	25	-
15	35	-
>24	Series Combination	-

For further details on surge in Tantalum capacitors refer to J.A. Gill's paper "Surge in Solid Tantalum Capacitors", available from AVX offices worldwide.

An added bonus of increasing the derating applied in a circuit, to improve the ability of the capacitor to withstand surge conditions, is that the steady-state reliability is improved by up to an order. Consider the example of a 6.3 volt capacitor being used on a 5 volt rail.

The steady-state reliability of a Tantalum capacitor is affected by three parameters; temperature, series resistance and voltage derating. Assume 40°C operation and 0.1 Ohms/Volt series resistance.

The capacitors reliability will therefore be:

$$\begin{aligned}
 \text{Failure rate} &= F_U \times F_T \times F_R \times 1\%/1000 \text{ hours} \\
 &= 0.15 \times 0.1 \times 1 \times 1\%/1000 \text{ hours} \\
 &= 0.015\%/1000 \text{ hours}
 \end{aligned}$$

If a 10 volt capacitor was used instead, the new scaling factor would be 0.006, thus the steady-state reliability would be:

$$\begin{aligned}
 \text{Failure rate} &= F_U \times F_T \times F_R \times 1\%/1000 \text{ hours} \\
 &= 0.006 \times 0.1 \times 1 \times 1\%/1000 \text{ hours} \\
 &= 6 \times 10^{-4} \%/1000 \text{ hours}
 \end{aligned}$$

So there is an order improvement in the capacitors steady-state reliability.

SECTION 4: APPLICATION GUIDELINES FOR TANTALUM AND OXICAP® CAPACITORS

Both Tantalum and OxiCap® are lead-free system compatible components, meeting requirements of J-STD-020 standard. The maximum conditions with care: Max. Peak Temperature: 260°C for maximum 10s, 3 reflow cycles. 2 cycles are allowed for F-series capacitors.

Small parametric shifts may be noted immediately after reflow, components should be allowed to stabilize at room temperature prior to electrical testing.

RECOMMENDED REFLOW PROFILE

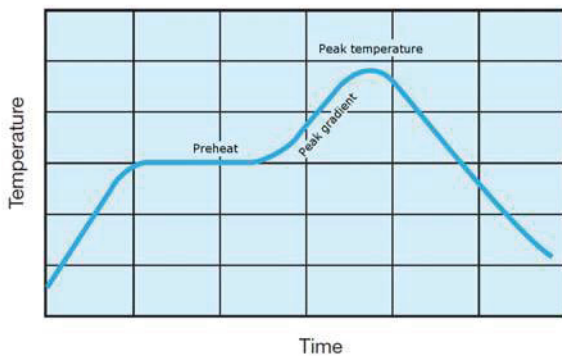

Lead-free soldering:

Pre-heating: 150±15°C/60–120sec.
 Max. Peak Temperature: 245±5°C
 Max. Peak Temperature Gradient: 2.5°C/sec.
 Max. Time above 230°C: 40sec. max.
 Time to Peak: 195sec.

SnPb soldering:

Pre-heating: 150±15°C/60–90sec.
 Max. Peak Temperature: 220±5°C
 Max. Peak Temperature Gradient: 2°C/sec.
 Max. Time above solder melting point: 60sec.

RECOMMENDED WAVE SOLDERING

Lead-free soldering:

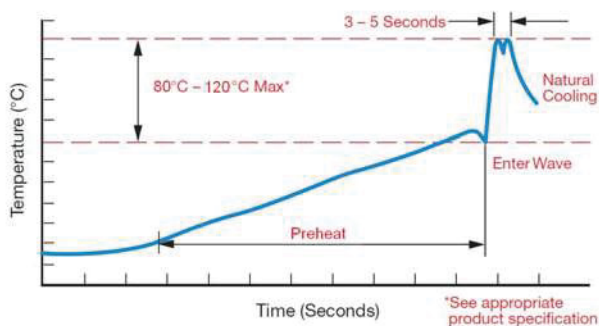

Pre-heating: 50-165°C/90-120sec.
 Max. Peak Temperature: 250-260°C
 Time of wave: 3-5sec.(max. 10sec.)

SnPb soldering:

Pre-heating: 50-165°C/90–120sec.
 Max. Peak Temperature: 240-250°C
 Time of wave: 3-5sec.(max.10sec.)

The upper side temperature of the board should not exceed +150°C.

GENERAL LEAD-FREE NOTES

The following should be noted by customers changing from lead based systems to the new lead free pastes.

- The visual standards used for evaluation of solder joints will need to be modified as lead-free joints are not as bright as with tin-lead pastes and the fillet may not be as large.
- Resin color may darken slightly due to the increase in temperature required for the new pastes.
- Lead-free solder pastes do not allow the same self alignment as lead containing systems. Standard mounting pads are acceptable, but machine set up may need to be modified.

Note: TCJ, TCM, TCN, J-CAP™, TCO, TCQ, F38, TLN and F98 series are not dedicated to wave soldering.

RECOMMENDED HAND SOLDERING

Recommended hand soldering condition:

Tip Diameter	Selected to fit Application
Max. Tip Temperature	+370°C
Max. Exposure Time	3s
Anti-static Protection	Non required

Note: TCJ, TCM, TCN, J-CAP™, TCO, TCQ, F38, TLN and F98 series are not dedicated to hand soldering.

SECTION 5: TERMINATIONS

5.1 Basic Materials

Two basic materials are used for termination leads: Nilo 42 (Fe58Ni42) and copper. Copper lead frame is mainly used for products requiring low ESR performance, while Nilo 42 is used for other products. The actual status of basic material per individual part type can be checked with AVX.

5.2 Termination Finishes - Coatings

Three terminations plating are available. Standard plating material is pure matte tin (Sn). Gold or tin-lead (SnPb) are available upon request with different part number suffix designations.*

5.2.1. Pure matte tin is used as the standard coating material meeting lead-free and RoHS requirements. AVX carefully monitors the latest findings on prevention of whisker formation. Currently used techniques include use of matte tin electrodeposition, nickel barrier underplating and recrystallization of surface by reflow. Terminations are tested for whiskers according to NEMI recommendations and JEDEC standard requirements. Data is available upon request.

5.2.2. Gold Plating is available as a special option* mainly for hybrid assembly using conductive glue.

5.2.3. Tin-lead (90%Sn 10%Pb) electroplated termination finish is available as a special option* upon request.

* Some plating options can be limited to specific part types. Please check availability of special options with AVX.

SECTION 6: MECHANICAL AND THERMAL PROPERTIES OF CAPACITORS

6.1 Acceleration

98.1m/s² (10g)

6.2 Vibration Severity

10 to 2000Hz, 0.75mm of 98.1m/s² (10g)

6.3 Shock

Trapezoidal Pulse, 98.1m/s² for 6ms.

6.4 Adhesion to Substrate

IEC 384-3. minimum of 5N.

6.5 Resistance to Substrate Bending

The component has compliant leads which reduces the risk of stress on the capacitor due to substrate bending.

6.6 Soldering Conditions

Dip soldering is permissible provided the solder bath temperature is 270°C, the solder time < 3 seconds and the circuit board thickness ≥ 1.0mm.

6.7 Installation Instructions

The upper temperature limit (maximum capacitor surface temperature) must not be exceeded even under the most unfavorable conditions when the capacitor is installed. This must be considered particularly when it is positioned near components which radiate heat strongly (e.g. valves and power transistors). Furthermore, care must be taken, when bending the wires, that the bending forces do not strain the capacitor housing.

6.8 Installation Position

No restriction.

6.9 Soldering Instructions

Fluxes containing acids must not be used.

6.9.1 Guidelines for Surface Mount Footprints

Component footprint and reflow pad design for AVX capacitors.

The component footprint is defined as the maximum board area taken up by the terminators. The footprint dimensions are given by A, B, C and D in the diagram, which corresponds to W₁ max., A max., S min. and L max. for the component. The footprint is symmetric about the center lines.

The dimensions x, y and z should be kept to a minimum to reduce rotational tendencies while allowing for visual inspection of the component and its solder fillet.

Dimensions PS (c for F-series) (Pad Separation) and PW (a for F-series) (Pad Width) are calculated using dimensions x and z. Dimension y may vary, depending on whether reflow or wave soldering is to be performed.

For reflow soldering, dimensions PL (b for positive terminal of F-series; b' for negative terminal of F-series) (Pad Length), PW (a) (Pad Width), and PSL (Pad Set Length) have been calculated. For wave soldering the pad width (PWw) is reduced to less than the termination width to minimize the amount of solder pick up while ensuring that a good joint can be produced. In the case of mounting conformal coated capacitors, excentering (Δc) is needed to except anode tab [4].

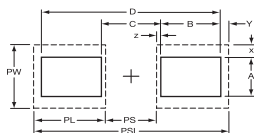

NOTE:

These recommendations (also in compliance with EIA) are guidelines only. With care and control, smaller footprints may be considered for reflow soldering.

Nominal footprint and pad dimensions for each case size are given in the following tables:

PAD DIMENSIONS:

millimeters (inches)

Case Size	PSL	PL	PS	PW	PWw
Series	A 4.00 (0.157)	1.40 (0.055)	1.20 (0.047)	1.80 (0.071)	0.90 (0.035)
SMD 'J' Lead & OxiCap® (excluding F-series)	B 4.00 (0.157)	1.40 (0.055)	1.20 (0.047)	2.80 (0.110)	1.60 (0.063)
	C 6.50 (0.256)	2.00 (0.079)	2.50 (0.098)	2.80 (0.110)	1.60 (0.063)
	D 8.00 (0.315)	2.00 (0.079)	4.00 (0.157)	3.00 (0.118)	1.70 (0.067)
	E 8.00 (0.315)	2.00 (0.079)	4.00 (0.157)	3.00 (0.118)	1.70 (0.067)
	F 6.50 (0.256)	2.00 (0.079)	2.50 (0.098)	2.80 (0.110)	1.60 (0.063)
	G 4.00 (0.157)	1.40 (0.055)	1.20 (0.047)	1.80 (0.071)	0.90 (0.035)
	H 4.00 (0.157)	1.40 (0.055)	1.20 (0.047)	2.80 (0.110)	1.60 (0.063)
	K 4.00 (0.157)	1.40 (0.055)	1.20 (0.047)	1.80 (0.071)	0.90 (0.035)
	L 4.00 (0.157)	1.40 (0.055)	1.20 (0.047)	2.80 (0.110)	1.60 (0.063)
	N 2.70 (0.106)	0.95 (0.037)	0.80 (0.031)	1.60 (0.063)	0.80 (0.031)
	P 2.70 (0.106)	0.95 (0.037)	0.80 (0.031)	1.60 (0.063)	0.80 (0.031)
	R 2.70 (0.106)	0.95 (0.037)	0.80 (0.031)	1.60 (0.063)	0.80 (0.031)
	S 4.00 (0.157)	1.40 (0.055)	1.20 (0.047)	1.80 (0.071)	0.90 (0.035)
	T 4.00 (0.157)	1.40 (0.055)	1.20 (0.047)	2.80 (0.110)	1.60 (0.063)
	U 8.00 (0.315)	2.00 (0.079)	4.00 (0.157)	3.70 (0.145)	1.80 (0.071)
	V 8.00 (0.315)	2.00 (0.079)	4.00 (0.157)	3.70 (0.145)	1.80 (0.071)
	W 6.50 (0.256)	2.00 (0.079)	2.50 (0.098)	2.80 (0.110)	1.60 (0.063)
	X 8.00 (0.315)	2.00 (0.079)	4.00 (0.157)	3.00 (0.118)	1.70 (0.067)
	Y 8.00 (0.315)	2.00 (0.079)	4.00 (0.157)	3.00 (0.118)	1.70 (0.067)
	Z 8.00 (0.315)	2.00 (0.079)	4.00 (0.157)	3.00 (0.118)	1.70 (0.067)
TACmicrochip® Series	A 4.40 (0.173)	1.60 (0.063)	1.20 (0.047)	1.80 (0.071)	0.90 (0.035)
	B 4.70 (0.185)	1.70 (0.067)	1.30 (0.051)	3.00 (0.118)	1.50 (0.059)
	C 4.40 (0.173)	1.60 (0.063)	1.20 (0.047)	1.80 (0.071)	0.90 (0.035)
	D 4.40 (0.173)	1.60 (0.063)	1.20 (0.047)	1.80 (0.071)	0.90 (0.035)
	E 0.90 (0.035)	0.30 (0.012)	0.30 (0.012)	0.30 (0.012)	N/A
	H 3.20 (0.126)	1.30 (0.051)	0.60 (0.024)	1.50 (0.059)	0.75 (0.030)
	I 4.40 (0.173)	1.60 (0.063)	1.20 (0.047)	1.80 (0.071)	0.90 (0.035)
	J 2.80 (0.110)	1.10 (0.043)	0.60 (0.024)	1.00 (0.039)	0.50 (0.019)
	K 2.20 (0.087)	0.90 (0.035)	0.40 (0.016)	0.70 (0.028)	0.35 (0.014)
	L 2.80 (0.110)	1.10 (0.043)	0.60 (0.024)	1.00 (0.039)	0.50 (0.019)
	M 3.20 (0.126)	1.30 (0.051)	0.60 (0.024)	1.00 (0.039)	0.50 (0.019)
	Q 3.20 (0.126)	1.30 (0.051)	0.60 (0.024)	1.50 (0.059)	0.75 (0.030)
	R 3.20 (0.126)	1.30 (0.051)	0.60 (0.024)	1.50 (0.059)	0.75 (0.030)
	S 4.40 (0.173)	1.60 (0.063)	1.20 (0.047)	1.80 (0.071)	0.90 (0.035)
	T 4.70 (0.185)	1.70 (0.067)	1.30 (0.051)	3.00 (0.118)	1.50 (0.059)
	U 3.20 (0.126)	1.30 (0.051)	0.60 (0.024)	1.50 (0.059)	0.75 (0.030)
V 4.40 (0.173)	1.60 (0.063)	1.20 (0.047)	1.80 (0.071)	0.90 (0.035)	
Z 2.80 (0.110)	1.10 (0.043)	0.60 (0.024)	0.70 (0.028)	0.35 (0.014)	

Note: SMD 'J' Lead = TAJ, TMJ, TPS, TPM, TRJ, TRM, THJ, TLJ, TCJ, TCM, TCO, TCQ

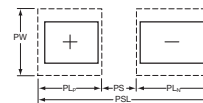

PAD DIMENSIONS:

millimeters (inches)

Case Size	PSL	PL _p	PS	PL _N	PW+	PW-
Series	M 2.50 (0.098)	1.05 (0.041)	0.40 (0.016)	1.05 (0.041)	1.00 (0.039)	1.00 (0.039)
TLN, TCN & J-CAP® Undertab	N 2.50 (0.098)	1.05 (0.041)	0.40 (0.016)	1.05 (0.041)	1.00 (0.039)	1.00 (0.039)
	O 3.60 (0.142)	1.35 (0.053)	0.90 (0.035)	1.35 (0.053)	1.30 (0.051)	1.30 (0.051)
	K 3.60 (0.142)	1.35 (0.053)	0.90 (0.035)	1.35 (0.053)	1.30 (0.051)	1.30 (0.051)
	S 3.60 (0.142)	1.35 (0.053)	0.90 (0.035)	1.35 (0.053)	1.30 (0.051)	1.30 (0.051)
	L 3.90 (0.154)	1.35 (0.053)	1.00 (0.039)	1.55 (0.061)	2.50 (0.098)	2.10 (0.083)
	T 3.90 (0.154)	1.35 (0.053)	1.00 (0.039)	1.55 (0.061)	2.50 (0.098)	2.10 (0.083)
	H 3.90 (0.154)	1.35 (0.053)	1.00 (0.039)	1.55 (0.061)	2.50 (0.098)	2.10 (0.083)
	X 7.70 (0.303)	2.20 (0.087)	2.10 (0.083)	3.40 (0.134)	3.25 (0.128)	3.25 (0.128)
	3 7.70 (0.303)	2.20 (0.087)	2.10 (0.083)	3.40 (0.134)	4.75 (0.187)	4.75 (0.187)
	4 7.70 (0.303)	2.20 (0.087)	2.10 (0.083)	3.40 (0.134)	4.75 (0.187)	4.75 (0.187)
	6 15.20 (0.598)	2.65 (0.104)	9.90 (0.390)	2.65 (0.104)	5.50 (0.217)	5.50 (0.217)
	B 8.00 (0.315)	2.30 (0.096)	3.40 (0.134)	2.30 (0.096)	4.40 (0.173)	4.40 (0.173)

PAD DIMENSIONS F-SERIES:

millimeters (inches)

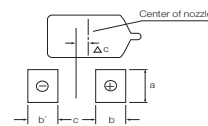

Case Size	a	b	b'	c	Δc*
Series	U 0.35 (0.014)	0.40 (0.016)	0.40 (0.016)	0.40 (0.016)	0.00
F38, F91, F92, F93, F97, F98	M 0.65 (0.026)	0.70 (0.028)	0.70 (0.028)	0.60 (0.024)	0.00
	S 0.90 (0.035)	0.70 (0.028)	0.70 (0.028)	0.80 (0.032)	0.00
	P 1.00 (0.039)	1.10 (0.043)	1.10 (0.043)	0.40 (0.016)	0.00
	A 1.30 (0.051)	1.40 (0.055)	1.40 (0.055)	1.00 (0.039)	0.00
	B 2.30 (0.091)	1.40 (0.055)	1.40 (0.055)	1.30 (0.051)	0.00
	C 2.30 (0.091)	2.00 (0.079)	2.00 (0.079)	2.70 (0.106)	0.00
	N 2.50 (0.098)	2.00 (0.079)	2.00 (0.079)	4.00 (0.157)	0.00
	R-P 1.40 (0.055)	0.60 (0.024)	0.50 (0.020)	0.70 (0.028)	0.20 (0.008)
F95, AUDIO F95 Conformal	Q-S 1.70 (0.067)	0.70 (0.028)	0.60 (0.024)	1.10 (0.043)	0.20 (0.008)
	A 1.80 (0.071)	0.70 (0.028)	0.60 (0.024)	1.10 (0.043)	0.20 (0.008)
	T 2.60 (0.102)	0.70 (0.028)	0.60 (0.024)	1.20 (0.047)	0.20 (0.008)
	B 2.60 (0.102)	0.80 (0.032)	0.70 (0.028)	1.10 (0.043)	0.20 (0.008)
F72 Conformal	R-M 5.80 (0.228)	1.20 (0.047)	1.20 (0.047)	3.90 (0.154)	0.50 (0.020)
	F75 Conformal	U-C 3.00 (0.118)	1.20 (0.047)	1.20 (0.047)	3.30 (0.130)
D 4.10 (0.161)		1.20 (0.047)	1.20 (0.047)	3.90 (0.154)	0.50 (0.020)
R-M 5.80 (0.228)		1.20 (0.047)	1.20 (0.047)	3.90 (0.154)	0.50 (0.020)

*In the case of mounting conformal coated capacitors, excentering (Δc) is needed to except anode tab [4].

PAD DIMENSIONS:

millimeters (inches)

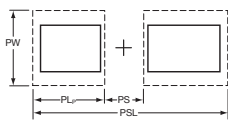

Case Size	PSL	PL	PS	PW	PW _w	
Series						
TCH & THH J-lead only	9	13.20 (0.520)	2.40 (0.094)	8.40 (0.331)	11.80 (0.465)	N/A
THH J-lead only	1	13.00 (0.512)	3.80 (0.150)	5.40 (0.213)	5.30 (0.210)	N/A
THH Undertab only	1	10.60 (0.417)	3.00 (0.118)	4.60 (0.181)	4.00 (0.157)	N/A

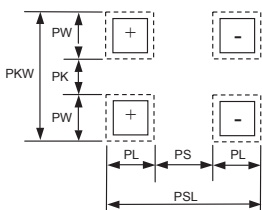

Case Size	PSL	PL	PS	PKW	PW	PK	
Series							
TCH & THH Undertab only	9	11.00(0.433)	1.70(0.067)	7.60(0.300)	10.60(0.417)	3.00(0.118)	4.60(0.181)

6.10 PCB Cleaning

Ta chip capacitors are compatible with most PCB board cleaning systems. If aqueous cleaning is performed, parts must be allowed to dry prior to test. In the event ultrasonics are used power levels should be less than 10 watts per/litre, and care must be taken to avoid vibrational nodes in the cleaning bath.

SECTION 7: EPOXY FLAMMABILITY

EPOXY	UL RATING	OXYGEN INDEX
TAJ/TMJ/TPS/TPM/TRJ/TRM/THJ TLJ/ TLN/TCJ/TCM/TCN/J-CAP™/TCO/TCQ/ NLJ/NOJ/NOS/NOM	UL94 V-0	35%

SECTION 8: QUALIFICATION APPROVAL STATUS

DESCRIPTION	STYLE	SPECIFICATION
Surface mount capacitors	TAJ	CECC 30801 - 005 Issue 2 CECC 30801 - 011 Issue 1

Material Data and Handling

This should be read in conjunction with the Product Datasheet. Failure to observe the ratings and the information on this sheet may result in a safety hazard.

1. Material Content

Solid Tantalum and OxiCap[®] capacitors do not contain liquid hazardous materials.

The operating section contains:

Tantalum/Niobium	Graphite/carbon
Tantalum/Niobium oxide	Conducting paint/resins
Manganese dioxide	Fluoropolymers (not TAC)

The encapsulation contains:

TAC - epoxy molding compound, solder/tin coated terminal pads

TAJ, TMJ, TPS, TPM, TRJ, TRM, TLJ, TLN, TCJ, TCM, TCN, J-CAP[™], TCO, TCQ, NLJ, NOJ, NOS and NOM - epoxy molding compound, tin/solder coated terminal pads

TAP - solder, solder coated terminal wires, epoxy dipped resin

The capacitors do not contain PBB or PBB0/PBBE. The solder alloys may contain lead.

2. Physical Form

These capacitors are physically small and are either rectangular with solderable terminal pads, or cylindrical or bead shaped with solderable terminal wires.

3. Intrinsic Properties

Operating

Both Tantalum and OxiCap[®] capacitors are polarized devices and operate satisfactorily in the correct d.c. mode. They will withstand a limited application of reverse voltage as stated in the datasheets. However, a reverse application of the rated voltage will result in early short circuit failure and may result in fire or explosion. Consequential failure of other associated components in the circuit e.g. diodes, transformers, etc. may also occur. When operated in the correct polarity, a long period of satisfactory operation will be obtained but failure may occur for any of the following reasons:

- normal failure rate
- surge voltage exceeded
- reverse voltage exceeded
- temperature too high
- ripple rating exceeded

If this failure mode is a short circuit, the previous conditions apply. If the adjacent circuit impedance is low, voltage or current surges may exceed the power handling capability of the capacitor. For this reason capacitors in circuits of below 1Ω/V should be derated by minimum 50% for tantalum and 20% for OxiCap[®]. Precautions should be taken to prevent reverse voltage spikes. Where capacitors may be subjected to fast switched, low impedance source voltages, the manufacturers advice should be sought to determine the most suitable capacitors for such applications.

Non-operating

Both Tantalum and OxiCap[®] capacitors contain no liquids or noxious gases to leak out. However, cracking or damage to the encapsulation may lead to premature failure due to ingress of material such as cleaning fluids or to stresses transmitted to the tantalum anode.

4. Fire Characteristics

Primary

Any component subject to abnormal power dissipation may

- self ignite
- become red hot
- break open or explode emitting flaming or red hot material, solid, molten or gaseous.

Fumes from burning components will vary in composition depending on the temperature, and should be considered to be hazardous, although fumes from a single component in a well ventilated area are unlikely to cause problems.

Secondary

Induced ignition may occur from an adjacent burning or red hot component. Epoxy resins used in the manufacture of capacitors give off noxious fumes when burning as stated above. Wherever possible, capacitors comply with the following:

BS EN 60065

UL 492.60A/280

LOI (ASTM D2863-70) as stated in the datasheets.

5. Storage

AVX Tantalum dielectric chip capacitors are unaffected by the following storage condition for 2 years:

Temperature: -10°C – +50°C

Humidity: 75% RH maximum

Atmospheric pressure: 860 mbar ~ 1060mbar

Tantalum and OxiCap[®] capacitors exhibit a very low random failure rate after long periods of storage and apart from this there are no known modes of failure under normal storage conditions. All capacitors will withstand any environmental conditions within their ratings for the periods given in the detail specifications. Storage for longer periods under high humidity conditions may affect the leakage current of resin protected capacitors. Solderability of solder coated surfaces may be affected by storage of excess of 2 years. If F-series capacitors should be stored more than 1 year please contact AVX for advice.

6. Moisture Sensitivity Level

MSL is defined in J-STD-020. It is applicable to non-hermetic surface mount devices, and is focussed on parts in plastic packages.

The basic concept is that a plastic package may contain moisture, which can become a high pressure vapour during solder reflow. If this occurs, the vapor pressure may cause internal cracking or damage to the device. It can also result in external steam jets from the package, and these may displace other nearby components on the circuit board during the solder process. A common industry reference for this is "popcorning".

AVX solid electrolyte chips (standard tantalum, conductive polymer, OxiCap[®]), which are considered MSL 3, MSL 4 or MSL 5 (ref. product datasheet) are molded in plastic packages, and are distributed in packaging including a moisture barrier.

AVX solid tantalum TACmicrochip[®] (TAC, TPC) are considered MSL 1 and supplied in packaging with a moisture barrier. TLC series is considered MSL 3 and is distributed in packaging including a moisture barrier.

Product Safety Information Datasheet

Material Data and Handling

The series, which are considered MSL 3, MSL 4 or MSL 5 are delivered in vacuum sealed bag with calculated shelf life:

- a) 12 months at < 40°C and < 90% relative humidity (RH)
- b) 24 months at < 30°C and < 70% relative humidity (RH)

7. Disposal

Incineration of epoxy coated capacitors will cause emission of noxious fumes and metal cased capacitors may explode due to build up of internal gas pressure. Disposal by any other means normally involves no special hazards. Large quantities may have salvage value.

8. Unsafe Use

Most failures are of a passive nature and do not represent a safety hazard. A hazard may, however, arise if this failure causes a dangerous malfunction of the equipment in which the capacitor is employed. Circuits should be designed to fail safe under the normal modes of failure. The usual failure mode is an increase in leakage current or short circuit. Other possible modes are decrease of capacitance, increase in dissipation factor (and impedance) or an open-circuit. Operations outside the ratings quoted in the datasheets represents unsafe use.

9. Handling

Careless handling of the cut terminal leads could result in scratches and/or skin punctures. Hands should be washed after handling solder coated terminals before eating or smoking, to avoid ingestion of lead. Capacitors must be kept out of the reach of small children.

Care must be taken to discharge capacitors before handling as capacitors may retain a residual charge even after equipment in which they are being used has been switched off. Sparks from the discharge could ignite a flammable vapor.

Environmental Information

AVX has always sought to minimize the environmental impact of its manufacturing operations and of its capacitors supplied to customers throughout the world. We have a policy of preventing and minimizing waste streams during manufacture, and recycling materials wherever possible. We actively avoid or minimize environmentally hazardous materials in our production processes.

1. Material Content

For customers wishing to assess the environmental impact of AVX's capacitors contained in waste electrical and electronic equipment, the following information is provided: Surface mount tantalum capacitors contain:

- Tantalum/Niobium and Tantalum/Niobium oxide
- Manganese dioxide
- Carbon/graphite
- Silver
- Tin/Tin-lead alloy plating
- Nickel-iron alloy or Copper alloy depending on design (consult factory for details)
- Polymers including fluorinated polymers
- Epoxide resin encapsulant

The encapsulant is made fire retardant to UL 94 V-0 by the inclusion of inert mineral filler and fire retardants.

2. Packaging Material

The component packing tape is recyclable Polycarbonate and the sealing tape is a laminate of halogen-free polymers. The reels are recyclable polystyrene, and marked with the recycling symbol. The reels are overpacked in recyclable fiber board boxes. None of the packing contains heavy metals.

3. Lead (Pb)

Parts supplied today are electroplated over the terminal contact area with 100% fused matte Tin (Sn). Parts with SnPb termination finish are available upon request only. Contact AVX for availability of parts with SnPb termination finish.

4. Fire Retardants

A combustible encapsulant free of antimony trioxide and organic bromide compound are supplied today. AVX believes that the health and safety

benefits of using these materials to provide fire retardancy during the life of the product, far outweigh the possible risks to the environment and human health.

5. Nickel Alloy

It is intended that all case sizes will be made with a high copper alloy termination. Some case sizes are supplied now with this termination, and other sizes may be available. Please contact AVX if you prefer this.

6. Recycling

Surface mount Tantalum and OxiCap® capacitors have a very long service life with no known wear-out mechanism, and a low failure rate. However, parts contained in equipment which is of no further use will have some residual value mainly because of the Tantalum metal or niobium oxide contained. This can be recovered and recycled by specialist companies. The silver and nickel or copper alloy will also have some value. Please contact AVX if you require assistance with the disposal of parts. Packaging can be recycled as described above.

7. Disposal

Surface mount Tantalum and OxiCap® capacitors do not contain any liquids and no part of the devices is normally soluble in water at neutral pH values. Incineration will cause the emission of noxious fumes and is not recommended except by specialists. Landfill may be considered for disposal, bearing in mind the small lead content.

Under certain extreme physical conditions it is possible to generate ignition of Tantalum, Niobium and Niobium oxide capacitors. These physical conditions relate to high-speed impact and although not considered to be a normal operating occurrence may occur as a method of material(s) recovery. Therefore appropriate safeguards procedures and methodologies need to be adopted to eliminate any risks of material ignition.

For further information, please contact your local AVX sales office or representative.

8. Typical Component Weight by Case Sizes

The approximate weight of capacitor by case size is in the table below. If the weight of specific part number is required, please contact manufacturer.

Case Size	TAJ, TMJ TPS, TRJ TLJ, THJ	TPM TRM	TLN	TCJ TCO TCQ	TCM	TCN J-CAP™	NOJ NOS NLJ	NOM	TAC TLC TPC	F38	F72	F75	F91, F93 F97	F92	F95	F98	F98-AJ6	TCH	THH
Typical Weight (mg)																			
A	29			28			25		57.3				28	19	37				
B	68			72			57		83.6				65	36	68				
C	166			137			154					240	160						
D	290	298		278			265		14			400	300						
E	512	527		472	474		392	402	0.5										
F	148						109												
G	28			25			23												
H	52			51		51			15.2										
I									12										543
J									5.9										
K	17		22	15			20		2.8										
L			41				38		9										
M			10				10		11.3	5.7	330					6	8		
N	9		10	9			10						350						
O							11												
P	15			15			12							9	18				
Q															20				
R	10			10					23.4		180	670			7				
S	19		27	18			25	17		12.4					25	13	14		
T	35		47	39			43	32	65.8						41				
U	738	673		642					8.5	1.2		160				1.6			
V	641	649		655	625		510		16.4										
W	99			100			82												
X	152			151			190	126											
Y	223	237		215			178												
Z							190		3.9										
3							251												
4			426				355												
5				429															
6			1056																
8							355												
9																		2185	2210

Environmental Information

9. RoHS Compliance

9.1 Tantalum & Niobium Oxide Capacitors (excluding F-series)

AVX can declare that we do not add any materials from the list below to series TAJ, TMJ, TPS, TPM, TRJ, TRM, THJ, TLJ, TLN, TCJ, TCM, TCN, J-CAP™, TCO, TCQ, TAC, TLC, TPC, NLJ, NOJ, NOS and NOM during production, so they are not contained in any significant level.

9.2 F-Series Eco-Products “GeoCap”

AVX promotes environmentally conscious practices.

AVX offers “GeoCap”, which has completely lead free terminals and contains no polyvinyl chloride in the sleeve.

Substances		Taping Code	RoHS Compliance
Heavy Metals	Cadmium and cadmium compounds	All	YES
	Lead and lead compounds	A,B,Y,P	YES
		R,S,T,U	YES, since production date 1/1/04
		K,H	NO
	Mercury and mercury compounds	All	YES
Hexavalent chromium compounds	All	YES	
Chlorinated organic compounds	Polychlorinated biphenyls (PCB)	All	YES
	Polychlorinated naphthalenes (PCN)	All	YES
	Chlorinated paraffins (CP)	All	YES
	Mirex (Perchlordecone)	All	YES
Brominated organic compounds	Polybrominated biphenyls (PBB)	All	YES
	Polybrominated diphenylethers (PBDE)	All	YES

F-SERIES TANTALUM CAPACITORS

Type • Classification		Series	Lead-Free Compliance	Anti Polyvinyl Chloride Compliance
Surface Mount type	Resin-Molded type	F38, F91, F92, F93, F97, F98	Complied	Complied
	Conformal Coated type	AUDIO F95, F95, F72, F75		

F-SERIES TANTALUM CAPACITORS CORRESPONDING TO ROHS DIRECTIVE

	Resin-Molded Chip F91/F92/F93/F97 Series	Conformal Coated Chip Audio F95/F95/F72/F75 Series	Facedown Terminal Resin-Molded Chip F98 Series	Conductive Polymer Facedown Terminal Resin-Molded Chip F38 Series
Compliance with RoHS Directive	Compliant	Compliant	Compliant	Compliant
Construction of Electrode Terminal	42 Alloy/ Ni/ Sn plating	Ni/ Sn-Cu solder	U Case Cu/ Ni/ Au/ Sn-3.5Ag plating M, S Case Cu/ Ni/ Au plating	Cu/ Ni/ Au plating
	Sn thickness 5µm Plating type matte No heat treatment after plating	Sn-Cu thickness 30µm (Solder dipping) No heat treatment after Solder dipping	U Case Sn-Ag thickness 5µm M, S Case Au thickness 0.05µm Plating type matte No heat treatment after plating	Au thickness 0.05µm Plating type matte No heat treatment after plating
Lead (Pb)	Does not contain	Does not contain	Does not contain	Does not contain
Chromium (VI)				
Mercury				
Cadmium				
PBB				
PBDE				
MSL (IPC/ JEDEC J-STD-020)	* LEVEL 1 to LEVEL 3 If you need detailed information about MSL LEVEL, please contact us.	LEVEL 3	LEVEL 3	LEVEL 3

Tantalum & Niobium Oxide Capacitors (excluding F-series)



Tape & Reel Packaging

Tape and reel packaging for automatic component placement. Please enter required Suffix on order. Bulk packaging is not available.

TAPE SPECIFICATION

Tape dimensions comply to EIA 481-1 Dimensions A0 and B0 of the pocket and the tape thickness, K, are dependent on the component size. Tape materials do not affect component solderability during storage. Carrier Tape Thickness <0.4mm.

TAPING SUFFIX TABLE TAJ, TMJ, TPS, TPM, TRJ, TRM, THJ, TLJ, TLN TCJ, TCM, TCN, J-CAP™, TCO, TCQ, NLJ, NOJ, NOS, NOM

Case Size	Tape width mm	P mm	180mm (7") reel Tin Termination			330mm (13") reel Tin Termination			180mm (7") reel Gold Termination	
			Suffix	Automotive Suffix	Qty.	Suffix	Automotive Suffix	Qty.	Suffix	Qty.
A	8	4	R	T	2,000	S	U	8,000	A	2,000
B	8	4	R	T	2,000	S	U	8,000	A	2,000
C	12	8	R	T	500	S	U	3,000	A	500
D	12	8	R	T	500	S	U	2,500	A	500
E	12	8	R	T	400	S	U	1,500	A	400
F	12	8	R	-	1,000	S	-	4,000	A	1,000
G	8	4	R	-	2,500	S	-	10,000	A	2,500
H	8	4	R	-	2,500	S	-	10,000	A	2,500
K	8	4	R	-	3,000	S	-	13,000	A	3,000
L	8	4	R	-	2,500	S	-	10,000	A	2,500
M	8	4	R	-	4,000	S	-	13,000	A	4,000
N	8	4	R	-	3,000	S	-	13,000	A	3,000
O	8	4	R	-	3,000	S	-	13,000	-	-
P	8	4	R	-	2,500	S	-	10,000	A	2,500
R	8	4	R	-	2,500	S	-	10,000	A	2,500
S	8	4	R	-	2,500	S	-	10,000	A	2,500
T	8	4	R	-	2,500	S	-	10,000	A	2,500
U	16	8	R	-	400	-	-	-	-	-
V	12	8	R	-	400	S	-	1,500	A	400
W	12	8	R	-	1,000	S	-	5,000	A	1,000
X	12	8	R	-	1,000	S	-	5,000	A	1,000
Y	12	8	R	-	1,000	S	-	4,000	A	1,000
Z	12	8	R	-	1,000	S	-	5,000	-	-
3	16	8	R	-	800	S	-	TBD	-	-
4	16	8	R	-	800	S	-	TBD	-	-
5	12	8	R	-	400	S	-	1,500	-	-
6	24	12	R	-	500	S	-	TBD	-	-
8	16	8	R	-	800	S	-	TBD	-	-

TAPING SUFFIX TABLE TAC AND TLC

Case Size	Tape width mm	P mm	108mm (4.25") reel Tin Termination		180mm (7") reel Tin Termination		108mm (4.25") reel & Gold Termination		180mm (7") reel & 100% Gold Termination	
			Suffix	Qty.	Suffix	Qty.	Suffix	Qty.	Suffix	Qty.
A	8	4	XTA	500	RTA	2,000	FTA	500	ATA	2,000
B	8	4	XTA	500	RTA	2,500	FTA	500	ATA	2,500
C	8	4	XTA	500	RTA	3,500	-	-	-	-
D	8	4	XTA	500	RTA	2,500	-	-	-	-
H	8	4	XTA	500	RTA	3,500	FTA	500	ATA	3,500
I	8	4	XTA	500	RTA	2,500	FTA	500	ATA	2,500
J	8	4	XTA	500	RTA	3,500	FTA	500	ATA	3,500
K	8	2	QTA	1,000	PTA	10,000	NTA	1,000	MTA	10,000
L	8	4	XTA	500	RTA	3,500	FTA	500	ATA	3,500
M	8	4	XTA	500	RTA	2,500	FTA	500	ATA	2,500
N	8	2	QTA	1,000	PTA	10,000	-	-	-	-
Q	8	4	XTA	500	RTA	2,500	-	-	-	-
R	8	4	XTA	500	RTA	2,500	FTA	500	ATA	2,500
S	8	4	XTA	500	RTA	2,500	-	-	-	-
T	8	4	XTA	500	RTA	2,500	FTA	500	ATA	2,500
U	8	4	XTA	500	RTA	3,500	FTA	500	ATA	3,500
V	8	4	XTA	500	RTA	2,500	FTA	500	ATA	2,500
Z	8	2	QTA	1,000	PTA	10,000	-	-	-	-

Under Development

CHIP TRAY (WAFFLE) TABLE TLC

Case Size	Chip Tray Qty.	Tin Termination Suffix	Gold Termination Suffix
E	Each	HTA	-



Tantalum & Niobium Oxide Capacitors (excluding F-series)

Tape & Reel Packaging



TAPING SUFFIX TABLE TPC

Case Size	Tape width mm	P mm	108mm (4.25") reel Tin Termination		180mm (7") reel Tin Termination		108mm (4.25") reel & Gold Termination		180mm (7") reel & 100% Gold Termination	
			Suffix	Qty.	Suffix	Qty.	Suffix	Qty.	Suffix	Qty.
H	8	4	Xxxxx	500	Rxxxx	3,500	Fxxxx	500	Axxxx	3,500
K	8	2	Qxxxx	1,000	Pxxxx	10,000	Nxxxx	1,000	Mxxxx	10,000
L	8	4	Xxxxx	500	Rxxxx	3,500	Fxxxx	500	Axxxx	3,500
R	8	4	Xxxxx	500	Rxxxx	2,500	Fxxxx	500	Axxxx	2,500

Note: xxxx = ESR value in Milliohms

TAPING SUFFIX TABLE TLC

Case Size	Tape width mm	P mm	108mm (4.25") reel Tin Termination		180mm (7") reel Tin Termination		108mm (4.25") reel & Gold Termination		180mm (7") reel & 100% Gold Termination	
			Suffix	Qty.	Suffix	Qty.	Suffix	Qty.	Suffix	Qty.
L	8	4	Xxxxx	500	Rxxxx	3,500	Fxxxx	500	Axxxx	3,500

Note: xxxx = ESR value in Milliohms

Tantalum & Niobium Oxide Capacitors (excluding F-series)



Tape & Reel Packaging

PLASTIC TAPE DIMENSIONS TAJ, TMJ, TPS, TPM, TRJ, TRM, THJ, TLJ, TLN, TCJ, TCM, TCN, J-CAP™, TCO, TCQ, NLJ, NOJ, NOS AND NOM

Case	A0±0.10	B0±0.10	K±0.10	W±0.30	E±0.10	F±0.05	G min.	P±0.10	P2±0.05	P0±0.10	D ^{+0.20} _{-0.00}	D1 ^{+0.25} _{-0.00}
A	1.83	3.57	1.87	8.00	1.75	3.50	0.75	4.00	2.00	4.00	1.50	1.00
B	3.15	3.77	2.22	8.00	1.75	3.50	0.75	4.00	2.00	4.00	1.50	1.00
C	3.45	6.40	2.92	12.00	1.75	5.50	0.75	8.00	2.00	4.00	1.50	1.50
D	4.48	7.62	3.22	12.00	1.75	5.50	0.75	8.00	2.00	4.00	1.50	1.50
E	4.50	7.50	4.50	12.00	1.75	5.50	0.75	8.00	2.00	4.00	1.50	1.50
F	3.35	6.40	2.20	12.00	1.75	5.50	0.75	8.00	2.00	4.00	1.50	1.50
G	1.83	3.57	1.65	8.00	1.75	3.50	0.75	4.00	2.00	4.00	1.50	1.00
H	3.15	3.77	1.66	8.00	1.75	3.50	0.75	4.00	2.00	4.00	1.50	1.00
K	1.95	3.55	1.15	8.00	1.75	3.50	0.75	4.00	2.00	4.00	1.50	1.00
L	3.10	3.80	1.30	8.00	1.75	3.50	0.75	4.00	2.00	4.00	1.50	1.00
M	1.60	2.35	1.10	8.00	1.75	3.50	0.75	4.00	2.00	4.00	1.50	1.00
N	1.60	2.30	1.10	8.00	1.75	3.50	0.75	4.00	2.00	4.00	1.50	1.00
O	1.95	3.55	0.80	8.00	1.75	3.50	0.75	4.00	2.00	4.00	1.50	1.00
P	1.65	2.45	1.60	8.00	1.75	3.50	0.75	4.00	2.00	4.00	1.50	1.00
R	1.65	2.45	1.30	8.00	1.75	3.50	0.75	4.00	2.00	4.00	1.50	1.00
S	1.95	3.55	1.30	8.00	1.75	3.50	0.75	4.00	2.00	4.00	1.50	1.00
T	3.20	3.80	1.30	8.00	1.75	3.50	0.75	4.00	2.00	4.00	1.50	1.00
U	6.19	7.66	4.72	16.00	1.75	7.50	0.75	8.00	2.00	4.00	1.50	1.50
V	6.43	7.44	3.84	12.00	1.75	5.50	0.75	8.00	2.00	4.00	1.50	1.50
W	3.57	6.40	1.65	12.00	1.75	5.50	0.75	8.00	2.00	4.00	1.50	1.50
X	4.67	7.62	1.65	12.00	1.75	5.50	0.75	8.00	2.00	4.00	1.50	1.50
Y	4.67	7.62	2.15	12.00	1.75	5.50	0.75	8.00	2.00	4.00	1.50	1.50
Z	4.67	7.62	1.65	12.00	1.75	5.50	0.75	8.00	2.00	4.00	1.50	1.50
3	6.25	7.88	2.25	16.00	1.75	7.50±0.1	0.75	8.00	2.00±0.1	4.00	1.50	1.50
4	6.25	7.88	2.25	16.00	1.75	7.50±0.1	0.75	8.00	2.00±0.1	4.00	1.50	1.50
5	4.50	7.50	4.50	12.00	1.75	5.50	0.75	8.00	2.00	4.00	1.50	1.50
6	8.55	15.60	2.25	24.00	1.75	11.50	0.75	12.00	2.00	4.00	1.50	1.50
8	6.25	7.88	2.25	16.00	1.75	7.50±0.1	0.75	8.00	2.00±0.1	4.00	1.50	1.50

PLASTIC TAPE DIMENSIONS TAC, TLC AND TPC

Case	A0±0.10	B0±0.10	K±0.10	W±0.30	E±0.10	F±0.05	G min.	P±0.10	P2±0.05	P0±0.10	D ^{+0.20} _{-0.00}	D1 ^{+0.20} _{-0.00}
A	1.83±0.10	3.57±0.10	1.87±0.10	8.00	1.75	3.50	0.75	4.00	2.00	4.00	1.50	1.00
B	3.15±0.10	3.77±0.10	1.66±0.10	8.00	1.75	3.50	0.75	4.00	2.00	4.00	1.50	1.00
C	1.95±0.10	3.55±0.10	1.15±0.10	8.00	1.75	3.50	0.75	4.00	2.00	4.00	1.50	1.00
D	1.95±0.10	3.60±0.10	0.90±0.10	8.00	1.75	3.50	0.75	4.00	2.00	4.00	1.50	1.00
H	1.65±0.10	2.45±0.10	1.10±0.05	8.00	1.75	3.50	0.75	4.00	2.00	4.00	1.50	1.00
I	1.95±0.10	3.60±0.10	0.90±0.10	8.00	1.75	3.50	0.75	4.00	2.00	4.00	1.50	1.00
J	1.05 ^{+0.10} _{-0.00}	1.90 ^{+0.10} _{-0.00}	0.80 ^{+0.10} _{-0.00}	8.00	1.75	3.50	0.75	4.00	2.00	4.00	1.50	0.80
K	0.75 ^{+0.15} _{-0.00}	1.26 ^{+0.10} _{-0.00}	0.67 ^{+0.10} _{-0.00}	8.00	1.75	3.50	0.75	2.00	2.00	2.00	1.50	0.50
L	1.05 ^{+0.10} _{-0.00}	1.90 ^{+0.10} _{-0.00}	1.05 ^{+0.10} _{-0.00}	8.00	1.75	3.50	0.75	4.00	2.00	4.00	1.50	0.80
M	1.05 ^{+0.10} _{-0.00}	2.45±0.10	1.05 ^{+0.10} _{-0.00}	8.00	1.75	3.50	0.75	4.00	2.00	4.00	1.50	0.80
Q	1.65±0.10	2.45±0.10	1.30±0.10	8.00	1.75	3.50	0.75	4.00	2.00	4.00	1.50	1.00
R	1.65±0.10	2.45±0.10	1.60±0.10	8.00	1.75	3.50	0.75	4.00	2.00	4.00	1.50	1.00
S	1.95±0.10	3.55±0.10	1.30±0.10	8.00	1.75	3.50	0.75	4.00	2.00	4.00	1.50	1.00
T	3.20±0.10	3.80±0.10	1.30±0.10	8.00	1.75	3.50	0.75	4.00	2.00	4.00	1.50	1.00
U	1.65±0.10	2.45±0.10	0.80±0.05	8.00	1.75	3.50	0.75	4.00	2.00	4.00	1.50	1.00
V	1.95±0.10	3.60±0.10	0.90±0.10	8.00	1.75	3.50	0.75	4.00	2.00	4.00	1.50	1.00
X	1.83±0.10	3.57±0.10	1.87±0.10	8.00	1.75	3.50	0.75	4.00	2.00	4.00	1.50	1.00
Z	1.75 ^{+0.05} _{-0.00}	1.90 ^{+0.10} _{-0.00}	0.67 ^{+0.10} _{-0.00}	8.00	1.75	3.50	0.75	2.00	2.00	2.00	1.50	0.50

Under development

CHIP TRAY (WAFFLE) TABLE TLC

Case	X Pocket Size	Y Pocket Size	Z Pocket Depth	A Pocket Draft Angle	Array
E	0.76mm ±0.05mm	0.43mm ±0.05mm	0.41mm ±0.05mm	5° ±1/2°	20 x 20 (400)

Tantalum & Niobium Oxide Capacitors (excluding F-series)

Tape & Reel Packaging

REEL DIMENSIONS

Reel Size	Tape	A	B	C	W	t
180mm (7")	16mm	180±2.00	50 min	13.0±0.50	16.4+2.0/-0	2.00±0.50
180mm (7")	12mm	180±2.00	50 min	13.0±0.50	12.4+1.5/-0	2.00±0.50
180mm (7")	8mm	180±2.00	50 min	13.0±0.50	8.4+1.5/-0	2.00±0.50
330mm (13")	12mm	330±2.00	50 min	13.0±0.50	12.4+1.5/-0	2.00±0.50
330mm (13")	8mm	330±2.00	50 min	13.0±0.50	8.4+1.5/-0	2.00±0.50
TACmicrochip®						
108mm (4.25")	8mm	108±2.00	50 min	13.0±0.50	8.4+1.5/-0	1.50±0.50
180mm (7")	8mm	180±2.00	50 min	13.0±0.50	8.4+1.5/-0	1.50±0.50

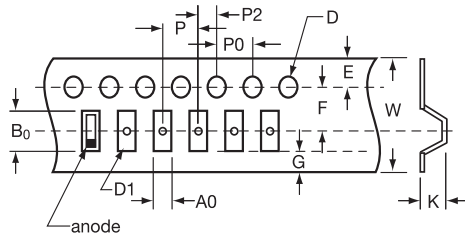
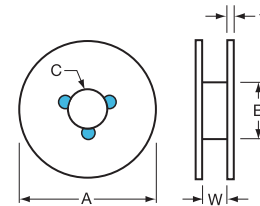

COVER TAPE NOMINAL DIMENSIONS

Thickness: 75µm
 Width of tape: 5.5mm (8mm tape)
 9.5mm (12mm tape)
 13.5mm (16mm tape)

TCH AND THH PACKAGING SPECIFICATION

The dimensions of the tray see in the figure below. Tolerance of dimensions are ±0.1 mm. Both case size "9" and "1" have 40 pcs per tray.

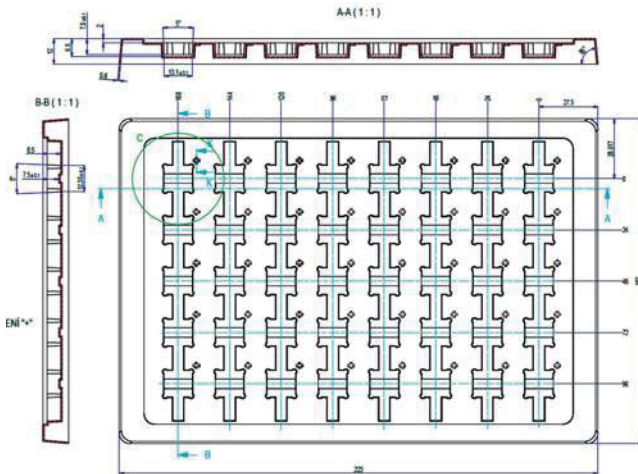

OVERALL CHIP TRAY SIZE

Size	Height	Flatness
50.80mm±0.10mm	3.96mm +0.05mm -0.08mm	0.10mm

PLASTIC CHIP TRAY

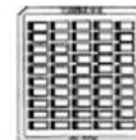
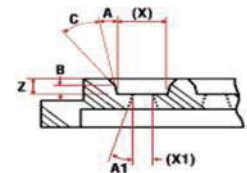
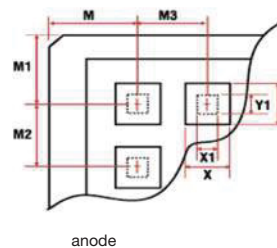

E Case

F-Series Tantalum Capacitors

Tape & Reel Packaging

TAPING QUANTITY TABLE – F-SERIES CAPACITORS

Series	Case Size	180mm (7") Reel Tin Termination	330mm (13") Reel Tin Termination
		Qty.	Qty.
F38, F98	U	10,000	–
	M, S	4,000	–
F92	P	3,000	8,000
	A, B	2,500	8,000
F91, F93, F97	A	2,000	8,000
	B	2,000	6,000
	C, N	500	2,500
F95 AUDIO F95	R, P	3,000	10,000
	Q, S, A, T	2,500	10,000
	B	2,000	8,500
F72	R	1,000	–
	M	500	–
F75	C, D, M, R, U	500	–

(*): Export packaging. There are some differences between actual minimum quantity and above list. Please confirm before you order.

TYPE NUMBERING SYSTEM

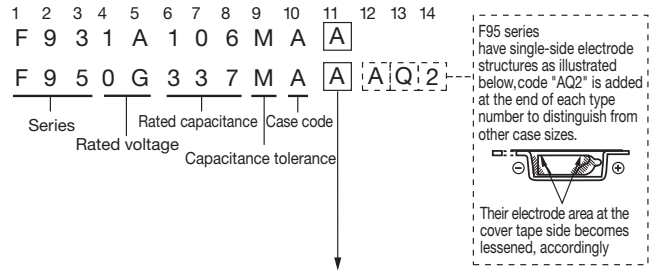

Tape Width (mm)	Polarity	Tape		Applicable Case Size		
		Reel Dia ϕ 180 mm	Reel Dia ϕ 330 mm	F91, F92, F93, F97, F98	F95 AUDIO F95	F72, F75
8	R (Anode is at opposite side of feeding holes)	A	E	U, M, S, P, A, B	R, P, Q, S, A, T, B	–
12	R (Anode is at opposite side of feeding holes)	C	G	C, N	–	U, C, D, R, M

REEL DIMENSIONS (mm)

Item	Reel Diameter	
	180 ϕ	330 ϕ
A	ϕ 180 $^{+0}_{-3}$	ϕ 330 \pm 2

Item	Tape Width	
	8	12
W ₁	9.0 \pm 0.3	13 \pm 0.3
W ₂	11.4 \pm 1.0	15.4 \pm 1.0

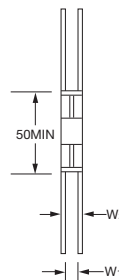
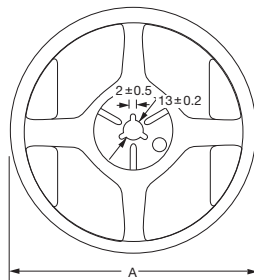

Note: The above shows the dimensions of 180 reel. In case of 330 reel, the appearance shape is slightly different.

CARRIER TAPE DIMENSIONS (mm)

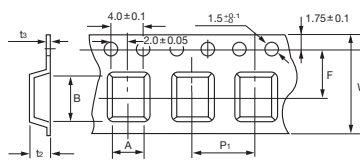

F91, F92, F93, F97, F98 M, F38 M

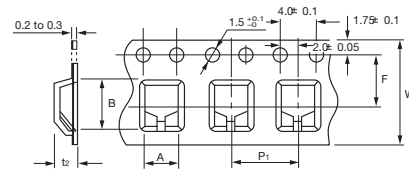

F95, AUDIO F95, F72, F75

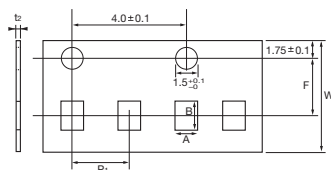

F98 U, F38 U

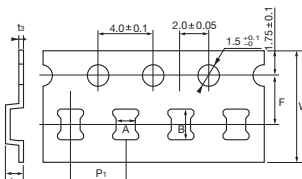

F98 S, F38 S

Case Code	W	A	B	F	P ₁	t ₂	t ₃
U	8.0 \pm 0.3	0.73 \pm 0.08	1.20 \pm 0.05	3.5 \pm 0.05	2.0 \pm 0.1	0.7 Max.	–
M	8.0 \pm 0.3	0.97 \pm 0.05	1.85 \pm 0.05	3.5 \pm 0.05	4.0 \pm 0.1	1.3 Max.	0.20 \pm 0.05
S	8.0 \pm 0.3	1.35 \pm 0.1	2.15 \pm 0.1	3.5 \pm 0.1	4.0 \pm 0.1	1.4 Max.	0.2 to 0.3
P	8.0 \pm 0.3	1.55 \pm 0.1	2.3 \pm 0.1	3.5 \pm 0.05	4.0 \pm 0.1	(1.7 Max.)	0.2 to 0.3
A	8.0 \pm 0.3	1.9 \pm 0.1	3.5 \pm 0.1	3.5 \pm 0.05	4.0 \pm 0.1	2.1 Max. (1.7)	0.2 to 0.3
B	8.0 \pm 0.3	3.3 \pm 0.1	3.8 \pm 0.1	3.5 \pm 0.05	4.0 \pm 0.1	2.4 Max. (1.7)	0.2 to 0.3
C	12.0 \pm 0.3	3.6 \pm 0.1	6.3 \pm 0.1	5.5 \pm 0.05	8.0 \pm 0.1	2.9 Max.	0.2 to 0.3
N	12.0 \pm 0.3	4.8 \pm 0.1	7.7 \pm 0.1	–	–	3.5 Max.	0.2 to 0.3

Type	Case Code	W	A	B	F	P ₁	t ₂
F95 AUDIO F95	R	8.0 \pm 0.3	1.5 \pm 0.2	2.6 \pm 0.2	3.5 \pm 0.05	4.0 \pm 0.1	1.05 Max.
	P						1.5 Max.
	Q, S						1.5 Max.
	A						2.0 Max.
	T						1.5 Max.
F72	B	12.0 \pm 0.3	3.25 \pm 0.2	3.7 \pm 0.2	5.5 \pm 0.1	8.0 \pm 0.1	2.4 Max.
	R						2.2 Max.
F75	M	12.0 \pm 0.3	6.6 \pm 0.2	7.8 \pm 0.2	5.5 \pm 0.1	8.0 \pm 0.1	2.5 Max.
	U						2.7 Max.
	C						3.6 Max.
	D						3.9 Max.
	M						3.3 Max.
R	4.6 Max.						

SECTION 1: ELECTRICAL CHARACTERISTICS AND EXPLANATION OF TERMS

1.1 CAPACITANCE

1.1.1 Rated capacitance (CR)

This is the nominal rated capacitance. For tantalum capacitors it is measured as the capacitance of the equivalent series circuit at 20°C in a measuring bridge supplied by a 120 Hz source free of harmonics with 2.2V DC bias max.

1.1.2 Temperature dependence on the capacitance

The capacitance of a tantalum capacitor varies with temperature. This variation itself is dependent to a small extent on the rated voltage and capacitor size. See graph below for typical capacitance changes with temperature.

Typical Capacitance vs. Temperature

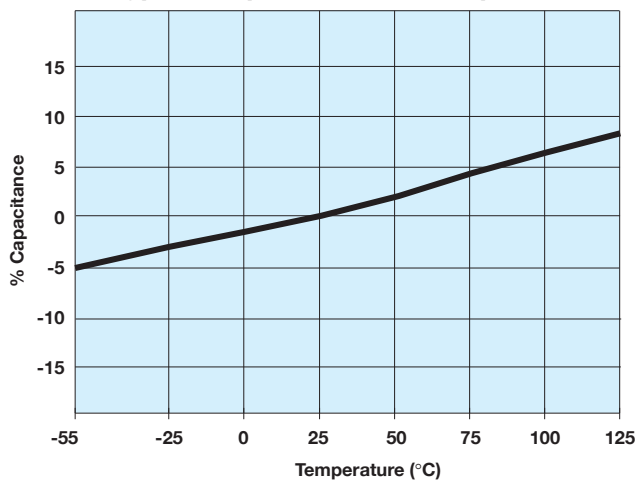

1.1.3 Capacitance tolerance

This is the permissible variation of the actual value of the capacitance from the rated value.

1.1.4 Frequency dependence of the capacitance

The effective capacitance decreases as frequency increases. Beyond 100 kHz the capacitance continues to drop until resonance is reached (typically between 0.5-5 MHz depending on the rating). Beyond this the device becomes inductive.

Typical Curve Capacitance vs. Frequency

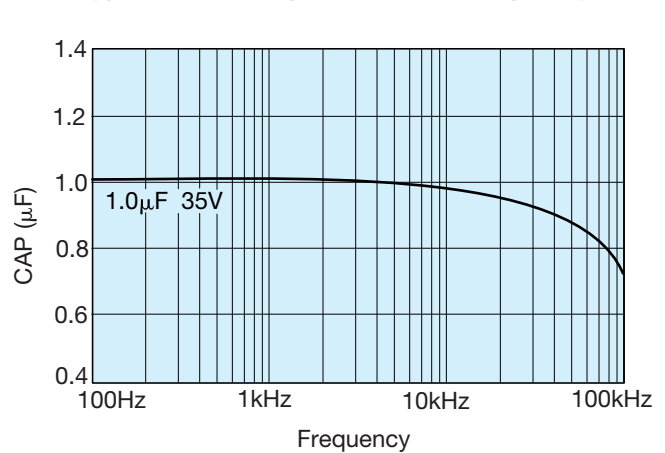

1.2 VOLTAGE

1.2.1 Rated DC voltage (V_R)

This is the rated DC voltage for continuous operation up to +85°C.

1.2.2 Category voltage (V_C)

This is the maximum voltage that may be applied continuously to a capacitor. It is equal to the rated voltage up to +85°C, beyond which it is subject to a linear derating, to 2/3 V_R at 125°C.

1.2.3 Surge voltage (V_S)

This is the highest voltage that may be applied to a capacitor for short periods of time. The surge voltage may be applied up to 10 times in an hour for periods of up to 30 seconds at a time. The surge voltage must not be used as a parameter in the design of circuits in which, in the normal course of operation, the capacitor is periodically charged and discharged.

Category Voltage vs. Temperature

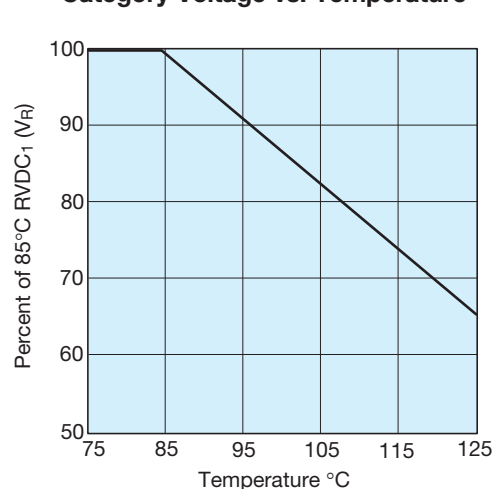

85°C		125°C	
Rated Voltage (V DC)	Surge Voltage (V DC)	Category Voltage (V DC)	Surge Voltage (V DC)
2	2.6	1.3	1.7
3	4	2	2.6
4	5.2	2.6	3.4
6.3	8	4	5
10	13	6.3	9
16	20	10	12
20	26	13	16
25	33	16	21
35	46	23	28
50	65	33	40

1.2.4 Effect of surges

The solid Tantalum capacitor has a limited ability to withstand surges (15% to 30% of rated voltage). This is in common with all other electrolytic capacitors and is due to the fact that they operate under very high electrical stress within the oxide layer. In the case of 'solid' electrolytic capacitors this is further complicated by the limited self healing ability of the manganese dioxide semiconductor.

It is important to ensure that the voltage across the terminals of the capacitor does not exceed the surge voltage rating at any time. This is particularly so in low impedance circuits where the capacitor is likely to be subjected to the full impact of surges, especially in low inductance applications. Even an extremely short duration spike is likely to cause damage. In such situations it will be necessary to use a higher voltage rating.

1.2.5 Reverse voltage and non-polar operation

The reverse voltage ratings are designed to cover exceptional conditions of small level excursions into incorrect polarity. The values quoted are not intended to cover continuous reverse operation.

The peak reverse voltage applied to the capacitor must not exceed:

10% of rated DC working voltage to a maximum of 1V at 25°C

3% of rated DC working voltage to a maximum of 0.5V at 85°C

1% of category DC working voltage to a maximum of 0.1V at 125°C

1.2.6 Non-polar operation

If the higher reverse voltages are essential, then two capacitors, each of twice the required capacitance and of equal tolerance and rated voltage, should be connected in a back-to-back configuration, i.e., both anodes or both cathodes joined together. This is necessary in order to avoid a reduction in life expectancy.

1.2.7 Superimposed AC voltage (V_{rms}) - Ripple Voltage

This is the maximum RMS alternating voltage, superimposed on a DC voltage, that may be applied to a capacitor. The sum of the DC voltage and the surge value of the superimposed AC voltage must not exceed the category voltage, V_c . Full details are given in Section 2.

1.2.8 Voltage derating

Refer to section 3.2 (pages 281-284) for the effect of voltage derating on reliability.

1.3 DISSIPATION FACTOR AND TANGENT OF LOSS ANGLE (TAN D)

1.3.1 Dissipation factor (DF)

Dissipation factor is the measurement of the tangent of the loss angle (Tan δ) expressed as a percentage.

The measurement of DF is carried out at +25°C and 120 Hz with 2.2V DC bias max. with an AC voltage free of harmonics. The value of DF is temperature and frequency dependent.

1.3.2 Tangent of loss angle (Tan δ)

This is a measure of the energy loss in the capacitor. It is expressed as Tan δ and is the power loss of the capacitor divided by its reactive power at a sinusoidal voltage of specified frequency. (Terms also used are power factor, loss factor and dielectric loss, Cos (90 - δ) is the true power factor.) The measurement of Tan δ is carried out at +20°C and 120 Hz with 2.2V DC bias max. with an AC voltage free of harmonics.

1.3.3 Frequency dependence of dissipation factor

Dissipation Factor increases with frequency as shown in the typical curves below.

Typical Curve-Dissipation Factor vs. Frequency

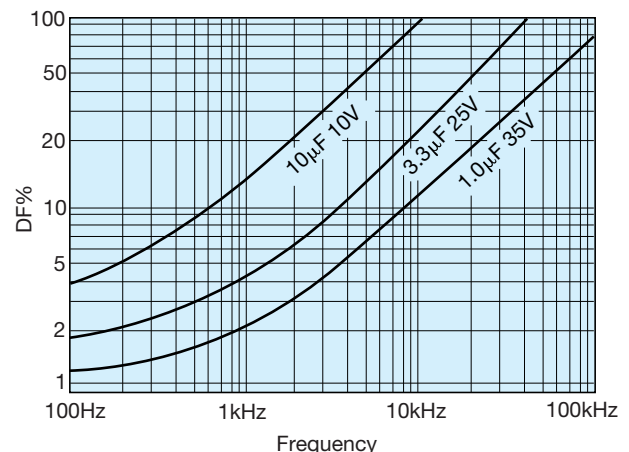

1.3.4 Temperature dependence of dissipation factor

Dissipation factor varies with temperature as the typical curves show to the right. For maximum limits please refer to ratings tables.

Typical Curves-Dissipation Factor vs. Temperature

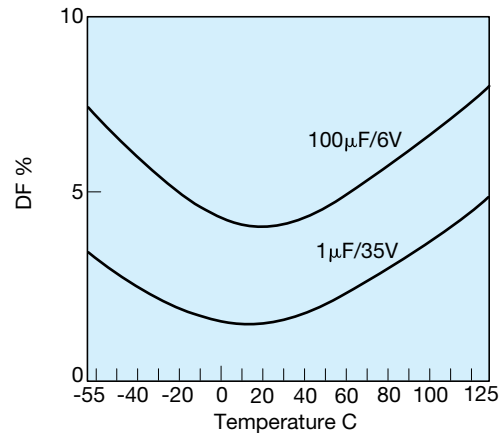

1.4 IMPEDANCE, (Z) AND EQUIVALENT SERIES RESISTANCE (ESR)

1.4.1 Impedance, Z

This is the ratio of voltage to current at a specified frequency. Three factors contribute to the impedance of a tantalum capacitor; the resistance of the semiconducting layer, the capacitance, and the inductance of the electrodes and leads.

At high frequencies the inductance of the leads becomes a limiting factor. The temperature and frequency behavior of these three factors of impedance determine the behavior of the impedance Z. The impedance is measured at 25°C and 100 kHz.

1.4.2 Equivalent series resistance, ESR

Resistance losses occur in all practical forms of capacitors. These are made up from several different mechanisms, including resistance in components and contacts, viscous forces within the dielectric, and defects producing bypass current paths. To express the effect of these losses they are considered as the ESR of the capacitor. The ESR is frequency dependent. The ESR can be found by using the relationship:

$$ESR = \frac{\tan \delta}{2\pi f C}$$

where f is the frequency in Hz, and C is the capacitance in farads. The ESR is measured at 25°C and 100 kHz.

ESR is one of the contributing factors to impedance, and at high frequencies (100 kHz and above) is the dominant factor, so that ESR and impedance become almost identical, impedance being marginally higher.

1.4.3 Frequency dependence of impedance and ESR

ESR and impedance both increase with decreasing frequency. At lower frequencies the values diverge as the extra contributions to impedance (resistance of the semiconducting layer, etc.) become more significant. Beyond 1 MHz (and beyond the resonant point of the capacitor) impedance again increases due to induction.

Frequency Dependence of Impedance and ESR

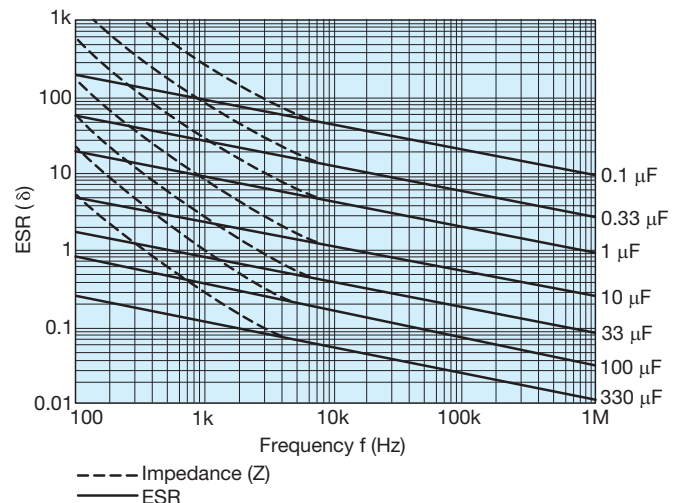

1.4.4 Temperature dependence of the impedance and ESR

At 100 kHz, impedance and ESR behave identically and decrease with increasing temperature as the typical curves show. For maximum limits at high and low temperatures, please refer to graph opposite.

1.5 DC LEAKAGE CURRENT (DCL)

1.5.1 Leakage current (DCL)

The leakage current is dependent on the voltage applied, the time, and the capacitor temperature. It is measured at +25°C with the rated voltage applied. A protective resistance of 1000 is connected in series with the capacitor in the measuring circuit.

Three minutes after application of the rated voltage the leakage current must not exceed the maximum values indicated in the ratings table. Reforming is unnecessary even after prolonged periods without the application of voltage.

1.5.2 Temperature dependence of the leakage current

The leakage current increases with higher temperatures, typical values are shown in the graph.

For operation between 85°C and 125°C, the maximum working voltage must be derated and can be found from the following formula.

$$V_{\max} = \left(1 - \frac{T-85}{120}\right) \times V_R \text{ volts}$$

where T is the required operating temperature. Maximum limits are given in rating tables.

1.5.3 Voltage dependence of the leakage current

The leakage current drops rapidly below the value corresponding to the rated voltage V_R when reduced voltages are applied. The effect of voltage derating on the leakage current is shown in the graph.

This will also give a significant increase in reliability for any application. See Section 3 (pages 278-283) for details.

1.5.4 Ripple current

The maximum ripple current allowance can be calculated from the power dissipation limits for a given temperature rise above ambient. Please refer to Section 2 (page 284) for details.

Temperature Dependence of the Impedance and ESR

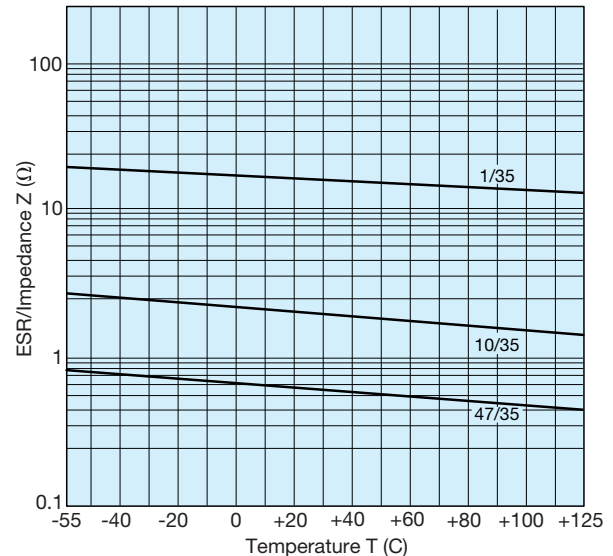

Temperature Dependence of the Leakage Current for a Typical Component

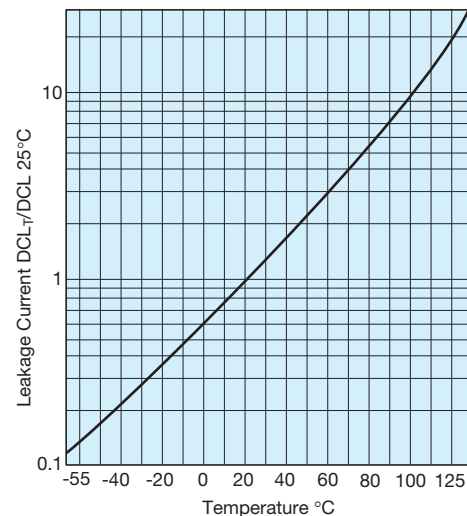

Effect of Voltage Derating on Leakage Current

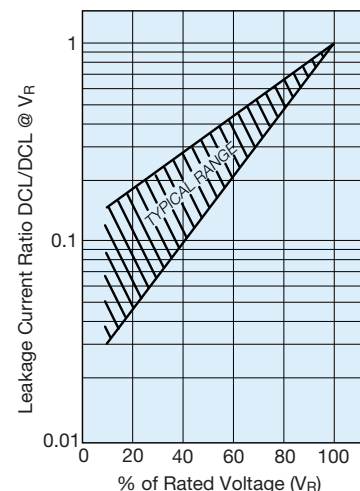

SECTION 2: A.C. OPERATION – RIPPLE VOLTAGE AND RIPPLE CURRENT

2.1 RIPPLE RATINGS (AC)

In an AC application heat is generated within the capacitor by both the AC component of the signal (which will depend upon signal form, amplitude and frequency), and by the DC leakage. For practical purposes the second factor is insignificant. The actual power dissipated in the capacitor is calculated using the formula:

$$P = I^2 R = \frac{E^2 R}{Z^2}$$

- I = rms ripple current, amperes
- R = equivalent series resistance, ohms
- E = rms ripple voltage, volts
- P = power dissipated, watts
- Z = impedance, ohms, at frequency under consideration

Using this formula it is possible to calculate the maximum AC ripple current and voltage permissible for a particular application.

2.2 MAXIMUM AC RIPPLE VOLTAGE (EMAX)

From the previous equation:

$$E_{(max)} = Z \sqrt{\frac{P_{max}}{R}}$$

where P_{max} is the maximum permissible ripple voltage as listed for the product under consideration (see table).

However, care must be taken to ensure that:

1. The DC working voltage of the capacitor must not be exceeded by the sum of the positive peak of the applied AC voltage and the DC bias voltage.
2. The sum of the applied DC bias voltage and the negative peak of the AC voltage must not allow a voltage reversal in excess of that defined in the sector, 'Reverse Voltage'.

2.3 MAXIMUM PERMISSIBLE POWER DISSIPATION (WATTS) @ 25°C

The maximum power dissipation at 25°C has been calculated for the various series and are shown in Section 2.4, together with temperature derating factors up to 125°C.

For leaded components the values are calculated for parts supported in air by their leads (free space dissipation).

The ripple ratings are set by defining the maximum temperature rise to be allowed under worst case conditions, i.e., with resistive losses at their maximum limit. This differential is normally 10°C at room temperature dropping to 2°C at 125°C. In application circuit layout, thermal management, available ventilation, and signal waveform may significantly affect the values quoted below. It is recommended that temperature measurements are made on devices during operating conditions to ensure that the temperature

differential between the device and the ambient temperature is less than 10°C up to 85°C and less than 2°C between 85°C and 125°C. Derating factors for temperatures above 25°C are also shown below. The maximum permissible proven dissipation should be multiplied by the appropriate derating factor.

For certain applications, e.g., power supply filtering, it may be desirable to obtain a screened level of ESR to enable higher ripple currents to be handled. Please contact our applications desk for information.

2.4 POWER DISSIPATION RATINGS (IN FREE AIR)

TAP/TEP – Resin Dipped Radial

Case size	Max. power dissipation (W)
A	0.045
B	0.05
C	0.055
D	0.06
E	0.065
F	0.075
G	0.08
H	0.085
J	0.09
K	0.1
L	0.11
M/N	0.12
P	0.13
R	0.14

Temperature derating factors	
Temp. °C	Factor
+25	1.0
+85	0.4
+125	0.09

SECTION 3: RELIABILITY AND CALCULATION OF FAILURE RATE

3.1 STEADY-STATE

Tantalum Dielectric has essentially no wear out mechanism and in certain circumstances is capable of limited self healing, random failures can occur in operation. The failure rate of Tantalum capacitors will decrease with time and not increase as with other electrolytic capacitors and other electronic components.

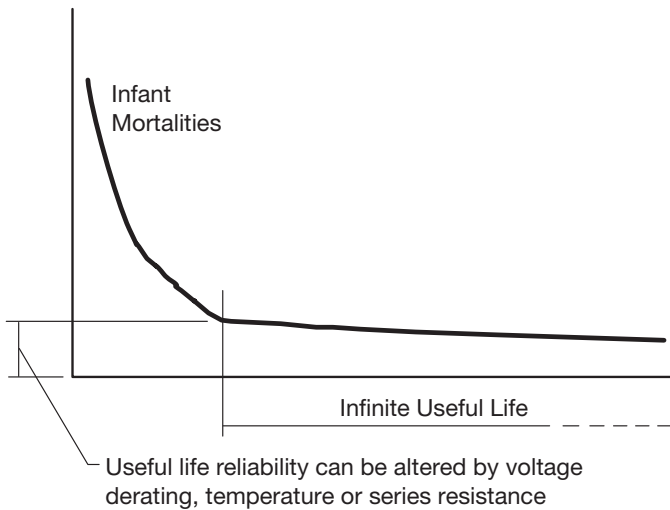

Figure 1. Tantalum reliability curve.

The useful life reliability of the Tantalum capacitor is affected by three factors. The equation from which the failure rate can be calculated is:

$$F = F_U \times F_T \times F_R \times F_B$$

where F_U is a correction factor due to operating voltage/voltage derating

F_T is a correction factor due to operating temperature

F_R is a correction factor due to circuit series resistance

F_B is the basic failure rate level. For standard leaded Tantalum product this is 1%/1000hours

Operating voltage/voltage derating

If a capacitor with a higher voltage rating than the maximum line voltage is used, then the operating reliability will be improved. This is known as voltage derating. The graph, Figure 2, shows the relationship between voltage derating (the ratio between applied and rated voltage) and the failure rate. The graph gives the correction factor F_U for any operating voltage.

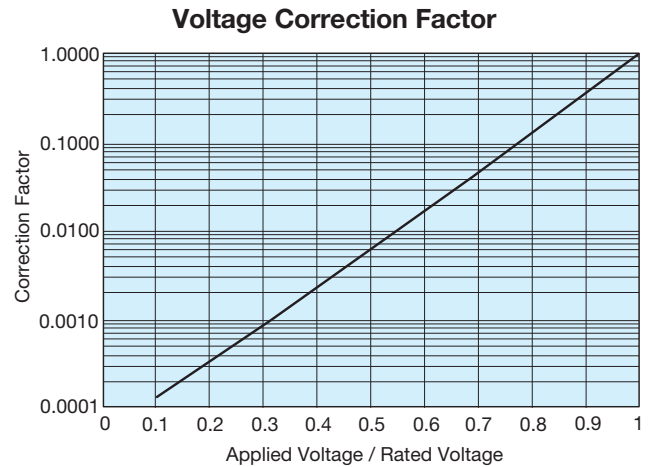

Figure 2. Correction factor to failure rate F for voltage derating of a typical component (60% con. level).

Operating temperature

If the operating temperature is below the rated temperature for the capacitor then the operating reliability will be improved as shown in Figure 3. This graph gives a correction factor F_T for any temperature of operation.

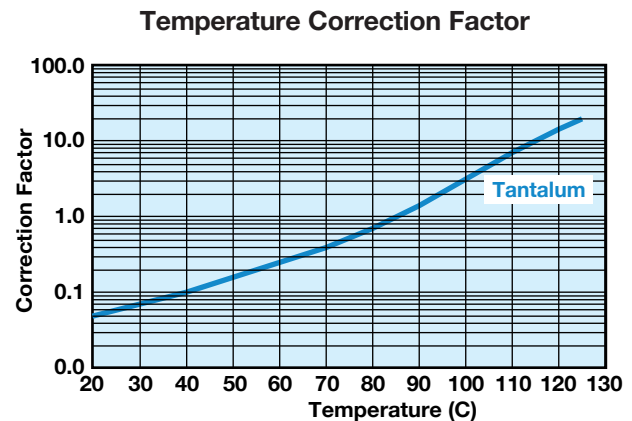

Figure 3. Correction factor to failure rate F for ambient temperature T for typical component (60% con. level).

Circuit Impedance

All solid tantalum capacitors require current limiting resistance to protect the dielectric from surges. A series resistor is recommended for this purpose. A lower circuit impedance may cause an increase in failure rate, especially at temperatures higher than 20°C. An inductive low impedance circuit may apply voltage surges to the capacitor and similarly a non-inductive circuit may apply current surges to the capacitor, causing localized over-heating and failure.

The recommended impedance is 1Ω per volt. Where this is not feasible, equivalent voltage derating should be used (See MIL HANDBOOK 217). Table I shows the correction factor, F_R , for increasing series resistance.

Table I: Circuit Impedance

Correction factor to failure rate F for series resistance R on basic failure rate F_B for a typical component (60% con. level).

Circuit Resistance ohms/volt	FR
3.0	0.07
2.0	0.1
1.0	0.2
0.8	0.3
0.6	0.4
0.4	0.6
0.2	0.8
0.1	1.0

Example calculation

Consider a 12 volt power line. The designer needs about 10μF of capacitance to act as a decoupling capacitor near a video bandwidth amplifier. Thus the circuit impedance will be limited only by the output impedance of the boards power unit and the track resistance. Let us assume it to be about 2 Ohms minimum, i.e., 0.167 Ohms/Volt. The operating temperature range is -25°C to +85°C. If a 10μF 16 Volt capacitor was designed-in, the operating failure rate would be as follows:

- a) $F_T = 0.8$ @ 85°C
- b) $F_R = 0.7$ @ 0.167 Ohms/Volt
- c) $F_U = 0.17$ @ applied voltage/rated voltage = 75%

Thus $F_B = 0.8 \times 0.7 \times 0.17 \times 1 = 0.0952\%/1000$ Hours

If the capacitor was changed for a 20 volt capacitor, the operating failure rate will change as shown.

$$F_U = 0.05 \text{ @ applied voltage/rated voltage} = 60\%$$

$$F_B = 0.8 \times 0.7 \times 0.05 \times 1 = 0.028\%/1000 \text{ Hours}$$

3.2 DYNAMIC

As stated in Section 1.2.4 (page 282), the solid Tantalum capacitor has a limited ability to withstand voltage and current surges. Such current surges can cause a capacitor to fail. The expected failure rate cannot be calculated by a simple formula as in the case of steady-state reliability. The two parameters under the control of the circuit design engineer known to reduce the incidence of failures are derating and series resistance. The table below summarizes the results of trials carried out at AVX with a piece of equipment which has very low series resistance and applied no derating. So that the capacitor was tested at its rated voltage.

Results of production scale derating experiment

Capacitance and Voltage	Number of units tested	50% derating applied	No derating applied
47μF 16V	1,547,587	0.03%	1.1%
100μF 10V	632,876	0.01%	0.5%
22μF 25V	2,256,258	0.05%	0.3%

As can clearly be seen from the results of this experiment, the more derating applied by the user, the less likely the probability of a surge failure occurring.

It must be remembered that these results were derived from a highly accelerated surge test machine, and failure rates in the low ppm are more likely with the end customer.

A commonly held misconception is that the leakage current of a Tantalum capacitor can predict the number of failures which will be seen on a surge screen. This can be disproved by the results of an experiment carried out at AVX on 47µF 10V surface mount capacitors with different leakage currents. The results are summarized in the table below.

Leakage Current vs Number of Surge Failures

	Number tested	Number failed surge
Standard leakage range 0.1 µA to 1µA	10,000	25
Over Catalog limit 5µA to 50µA	10,000	26
Classified Short Circuit 50µA to 500µA	10,000	25

Again, it must be remembered that these results were derived from a highly accelerated surge test machine, and failure rates in the low ppm are more likely with the end customer.

AVX recommended derating table

Voltage Rail	Working Cap Voltage
3.3	6.3
5	10
10	20
12	25
15	35
≥24	Series Combinations (11)

For further details on surge in Tantalum capacitors refer to J.A. Gill's paper "Surge in Solid Tantalum Capacitors", available from AVX offices worldwide.

An added bonus of increasing the derating applied in a circuit, to improve the ability of the capacitor to withstand surge conditions, is that the steady-state reliability is improved by up to an order. Consider the example of a 6.3 volt capacitor being used on a 5 volt rail. The steady-state reliability of a Tantalum capacitor is affected by three parameters; temperature, series resistance and voltage derating. Assuming 40°C operation and 0.1Ω/volt of series resistance, the scaling factors for temperature and series resistance will both be 0.05 [see Section 3.1 (page 286)]. The derating factor will be 0.15. The capacitors reliability will therefore be

$$\begin{aligned} \text{Failure rate} &= F_U \times F_T \times F_R \times 1\%/1000 \text{ hours} \\ &= 0.15 \times 0.05 \times 1 \times 1\%/1000 \text{ hours} \\ &= 7.5\% \times 10^{-3}/\text{hours} \end{aligned}$$

If a 10 volt capacitor was used instead, the new scaling factor would be 0.017, thus the steady-state reliability would be

$$\begin{aligned} \text{Failure rate} &= F_U \times F_T \times F_R \times 1\%/1000 \text{ hours} \\ &= 0.017 \times 0.05 \times 1 \times 1\%/1000 \text{ hours} \\ &= 8.5\% \times 10^{-4}/1000 \text{ hours} \end{aligned}$$

So there is an order improvement in the capacitors steady-state reliability.

3.3 RELIABILITY TESTING

AVX performs extensive life testing on tantalum capacitors.

- 2,000 hour tests as part of our regular Quality Assurance Program.

Test conditions:

- 85°C/rated voltage/circuit impedance of 3Ω max.
- 125°C/0.67 x rated voltage/circuit impedance of 3Ω max.

3.4 Mode of Failure

This is normally an increase in leakage current which ultimately becomes a short circuit.

SECTION 4: APPLICATION GUIDELINES FOR TANTALUM CAPACITORS

4.1 SOLDERING CONDITIONS AND BOARD ATTACHMENT

The soldering temperature and time should be the minimum for a good connection.

A suitable combination for wavesoldering is 230°C - 250°C for 3 - 5 seconds.

Small parametric shifts may be noted immediately after wave solder, components should be allowed to stabilize at room temperature prior to electrical testing.

AVX leaded tantalum capacitors are designed for wave soldering operations.

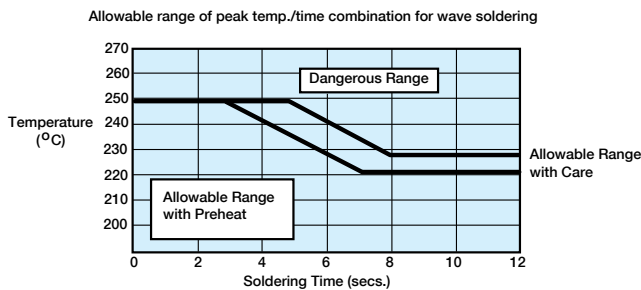

4.2 RECOMMENDED SOLDERING PROFILES

Recommended wave soldering profile for mounting of tantalum capacitors is shown below.

After soldering the assembly should preferably be allowed to cool naturally. In the event that assisted cooling is used, the rate of change in temperature should not exceed that used in reflow.

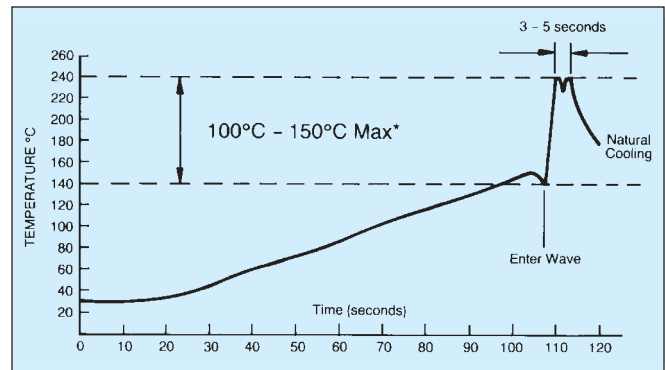

*See appropriate product specification

SECTION 5: MECHANICAL AND THERMAL PROPERTIES, LEADED CAPACITORS

5.1 ACCELERATION

10 g (981 m/s)

5.2 VIBRATION SEVERITY

10 to 2000 Hz, 0.75 mm or 98 m/s²

5.3 SHOCK

Trapezoidal Pulse 10 g (981 m/s) for 6 ms

5.4 TENSILE STRENGTH OF CONNECTION

10 N for type TAR, 5 N for type TAP/TEP.

5.5 BENDING STRENGTH OF CONNECTIONS

2 bends at 90°C with 50% of the tensile strength test loading.

5.6 SOLDERING CONDITIONS

Dip soldering permissible provided solder bath temperature $\leq 270^\circ\text{C}$; solder time <3 sec.; circuit board thickness ≥ 1.0 mm.

5.7 INSTALLATION INSTRUCTIONS

The upper temperature limit (maximum capacitor surface temperature) must not be exceeded even under the most unfavorable conditions when the capacitor is installed. This must be considered particularly when it is positioned near components which radiate heat strongly (e.g., valves and power transistors). Furthermore, care must be taken, when bending the wires, that the bending forces do not strain the capacitor housing.

5.8 INSTALLATION POSITION

No restriction.

5.9 SOLDERING INSTRUCTIONS

Fluxes containing acids must not be used.

QUESTIONS AND ANSWERS

Some commonly asked questions regarding Tantalum Capacitors:

Question: If I use several tantalum capacitors in serial/ parallel combinations, how can I ensure equal current and voltage sharing?

Answer: Connecting two or more capacitors in series and parallel combinations allows almost any value and rating to be constructed for use in an application.

For example, a capacitance of more than 60µF is required in a circuit for stable operation. The working voltage rail is 24 Volts dc with a superimposed ripple of 1.5 Volts at 120 Hz.

The maximum voltage seen by the capacitor is $V_{dc} + V_{ac} = 25.5V$

Applying the 50% derate rule tells us that a 50V capacitor is required.

Connecting two 25V rated capacitors in series will give the required capacitance voltage rating, but the effective capacitance will be halved, so for greater than



60µF, four such series combinations are required, as shown.

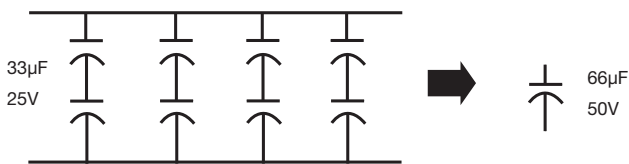

In order to ensure reliable operation, the capacitors should be connected as shown below to allow current sharing of the ac noise and ripple signals. This prevents any one capacitor heating more than its neighbors and thus being the weak link in the chain.

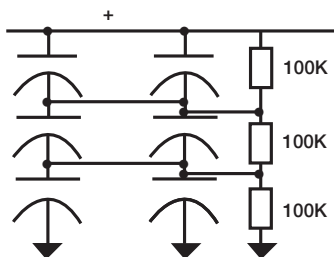

The two resistors are used to ensure that the leakage currents of the capacitors does not affect the circuit reliability, by ensuring that all the capacitors have half the working voltage across them.

Question: What are the advantages of tantalum over other capacitor technologies?

Answer:

1. Tantalums have high volumetric efficiency.
2. Electrical performance over temperature is very stable.
3. They have a wide operating temperature range -55 degrees C to +125 degrees C.
4. They have better frequency characteristics than aluminum electrolytics.
5. No wear out mechanism. Because of their construction, solid tantalum capacitors do not degrade in performance or reliability over time.

Question: If the part is rated as a 25 volt part and you have current surged it, why can't I use it at 25 volts in a low impedance circuit?

Answer: The high volumetric efficiency obtained using tantalum technology is accomplished by using an extremely thin film of tantalum pentoxide as the dielectric. Even an application of the relatively low voltage of 25 volts will produce a large field strength as seen by the dielectric. As a result of this, derating has a significant impact on reliability as described under the reliability section. The following example uses a 22 microfarad capacitor rated at 25 volts to illustrate the point. The equation for determining the amount of surface area for a capacitor is as follows:

$$C = ((E)(E^{\circ})(A)) / d$$

$$A = ((C)(d)) / ((E^{\circ})(E))$$

$$A = ((22 \times 10^{-6})(170 \times 10^{-9})) / ((8.85 \times 10^{-12})(27))$$

$$A = 0.015 \text{ square meters (150 square centimeters)}$$

Where C = Capacitance in farads

- A = Dielectric (Electrode) Surface Area (m²)
- d = Dielectric thickness (Space between dielectric) (m)
- E = Dielectric constant (27 for tantalum)
- E[°] = Dielectric Constant relative to a vacuum (8.855 x 10⁻¹² Farads x m⁻¹)

To compute the field voltage potential felt by the dielectric we use the following logic.

$$\text{Dielectric formation potential} = \text{Formation Ratio} \times \text{Working Voltage}$$

$$= 4 \times 25$$

$$\text{Formation Potential} = 100 \text{ volts}$$

$$\text{Dielectric (Ta}_2\text{O}_5\text{) Thickness (d) is } 1.7 \times 10^{-9} \text{ Meters Per Volt}$$

$$d = 0.17 \mu \text{ meters}$$

$$\text{Electric Field Strength} = \text{Working Voltage} / d$$

$$= (25 / 0.17 \mu \text{ meters})$$

$$= 147 \text{ Kilovolts per millimeter}$$

$$= 147 \text{ Megavolts per meter}$$

QUESTIONS AND ANSWERS

No matter how pure the raw tantalum powder or the precision of processing, there will always be impurity sites in the dielectric. We attempt to stress these sites in the factory with overvoltage surges, and elevated temperature burn in so that components will fail in the factory and not in your product.

Unfortunately, within this large area of tantalum pentoxide, impurity sites will exist in all capacitors. To minimize the possibility of providing enough activation energy for these impurity sites to turn from an amorphous state to a crystalline state that will conduct energy, series resistance and derating is recommended. By reducing the electric field within the anode at these sites, the tantalum capacitor has increased reliability. Tantalums differ from other electrolytics in that charge transients are carried by electronic conduction rather than absorption of ions.

Question: What negative transients can Solid Tantalum Capacitors operate under?

Answer: The reverse voltage ratings are designed to cover exceptional conditions of small level excursions into incorrect polarity. The values quoted are not intended to cover continuous reverse operation. The peak reverse voltage applied to the capacitor must not exceed:

10% of rated DC working voltage to a maximum of 1 volt at 25°C.

3% of rated DC working voltage to a maximum of 0.5 volt at 85°C.

1% of category DC working voltage to a maximum of 0.1 volt at 125°C.

Question: I have read that manufacturers recommend a series resistance of 0.1 ohm per working volt. You suggest we use 1 ohm per volt in a low impedance circuit. Why?

Answer: We are talking about two very different sets of circuit conditions for those recommendations. The 0.1 ohm per volt recommendation is for steady-state conditions. This level of resistance is used as a basis for the series resistance variable in a 1% / 1000 hours 60% confidence level reference. This is what steady-state life tests are based on. The 1 ohm per volt is recommended for dynamic conditions which include current in-rush applications such as inputs to power supply circuits. In many power supply topologies where the di/dt through the capacitor(s) is limited, (such as most implementations of buck (current mode), forward converter, and flyback), the requirement for series resistance is decreased.

Question: How long is the shelf life for a tantalum capacitor?

Answer: Solid tantalum capacitors have no limitation on shelf life. The dielectric is stable and no reformation is required. The only factors that affect future performance of the capacitors would be high humidity conditions and extreme storage temperatures. Solderability of solder coated surfaces may be affected by storage in excess of 2 years. Recommended storage conditions are: Temperature between -10°C – +50°C with humidity 75% RH maximum and atmospheric pressure 860 mbar-1060 mbar. Terminations should be checked for solderability in the event an oxidation develops on the solder plating.

Question: Are any recommendations/limitation for capacitor selection in parallel combination of capacitors?

Answer: Higher performance series TPS, TPM, NOS, NOM, TCJ, TCN are designed to provide lower ESR values and make the product more robust against current surges. The design differences make the better performance distribution of parameters, namely ESR is lower and tighter compared to the general purpose TAJ series. The surge current load in a parallel combination of capacitors is therefore shared more evenly amongst the capacitors and thus it is better suited for this application.

In a parallel combination is is strongly recommended to use the low ESR series of Tantalum Capacitors such as TPS, TPM, NOS, NOM, TCJ and TCN. Do not combine different series of manufacturers within one parallel combination.

Question: What level of voltage derating is needed for Tantalum Capacitors?

Answer: For many years whenever people have asked a tantalum capacitor manufacturer about what were the safe guidelines for using their product, they spoke with one voice “a minimum of 50% voltage derating should be applied”. This message has since become ingrained and automatic. This article challenges this statement and explains why it is not necessarily the case.

The 50% rule came about when tantalum capacitors started to be used on low impedance sources. In such applications, the available current is high and therefore a risk of failure is inherent. Well established by empirical methods and covered in MIL-STD 317, was the fact that the amount of voltage derating has a major influence on the failure rate of a tantalum capacitor (Figure 1). Indeed, from rated voltage to 50% of rated voltage is an improvement in failure rate of more than 100.

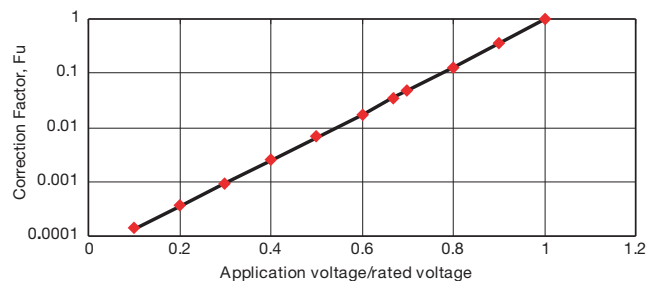
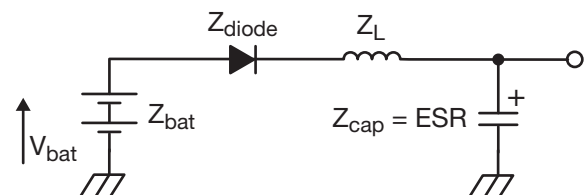

Figure 1

It was also proved that the same was true of dynamic, high current pulse conditions¹, hence the recommendation.

Now let us look more closely at the type of circuits in use. Below is a simple circuit which will be discussed further in this text.



Let us assume this is a 2 cell battery system, therefore

$$V_{\text{bat}} = 3.2 \text{ Volts}$$

Also, let us assume

$$Z_{\text{bat}} = 60 \text{ m}\Omega, Z_{\text{diode}} = 70 \text{ m}\Omega, Z_{\text{cap}} = 120 \text{ m}\Omega, Z_L = 70 \text{ m}\Omega$$

If the "50% rule" was followed, the designer should chose a 6.3V rated capacitor.

The total circuit impedance of the system is 320 m Ω . So by Ohm's law the peak current would be 10 Amps.

This exceeds the test conditions used by AVX to screen its product for high current pulses¹, so a risk of failure exists. Clearly a minimum of a 10 volt rate capacitor is required in this application.

As a general rule of thumb, the maximum current a tantalum capacitor can withstand (provided it has not been damaged by thermomechanical damage^{2 3} or some other external influence) is given by the equation:

$$I_{\text{max}} = V_{\text{rated}} / (1 + \text{Catalog ESR})$$

So for example for a 100 μ F 10V D case capacitor (Catalog ESR = 0.9 Ohms), this would be:

$$I_{\text{max}} = 10 / (1 + 0.9) = 5.2 \text{ Amps}$$

In some circuits, because of size restrictions, a tantalum capacitor may be the only option available. If this is the case, AVX recommends a PFET integrator be used to slow the voltage ramp at turn on, which in effect reduces the peak current, and therefore reduces the risk of failure⁴.

Now, let's consider a continuation of the circuit with the addition of an LDO or DC/DC convertor.

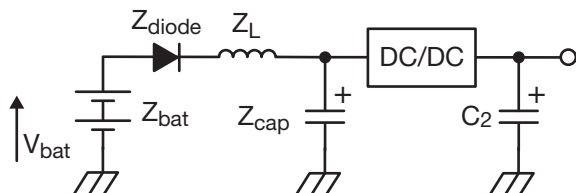

The risk of a high surge current being seen by the capacitor in location C₂ is very small. Therefore if we assume the voltage rail is 2.8 volts and the maximum current seen by C₂ is <1.5 Amps, a 4 volt capacitor could be able to be used in this application.

This all seems like good news, but as always, there are some downsides to using a part nearer to its rated voltage. The first is the steady-state life, or MTBF. The MTBF of a tantalum capacitor is easily calculated from MIL-STD 317 or the supplier's catalog data. An example is given below:

Assume operating temperature is 85°C and circuit impedance 0.1 Ohms/volt (F_T = 1).

For a 10 volt rated capacitor on a 5 volt rated line, the failure rate is:

$$\begin{aligned} F_R &= 1\%/1000 \text{ hours} \times F_T \times F_U \times F_R \\ &= 1\%/1000 \text{ hours} \times 1 \times 0.007 \text{ (from Figure 1)} \times 1 \\ &= 0.007\%/1000 \text{ hours} \end{aligned}$$

$$\text{MTBF} = 10^5 / F_R$$

$$= 14,285,238 \text{ hours}$$

$$= 1,631 \text{ years}$$

For a 6.3 volt rated capacitor on a 5 volt rated line, the failure rate is:

$$\begin{aligned} F_R &= 1\%/1000 \text{ hours} \times F_T \times F_U \times F_R \\ &= 1\%/1000 \text{ hours} \times 1 \times 0.12 \text{ (from Figure 1)} \times 1 \\ &= 0.12\%/1000 \text{ hours} \end{aligned}$$

$$\text{MTBF} = 10^5 / F_R$$

$$= 833,333 \text{ hours}$$

$$= 95 \text{ years}$$

The second factor to be considered is that the more derating applied to a tantalum capacitor, the lower the leakage current level (Figure 2). Therefore a part used at 50% of its rated voltage will have more than 3 times better leakage levels than one used at 80%.

Leakage Current vs. Rated Voltage

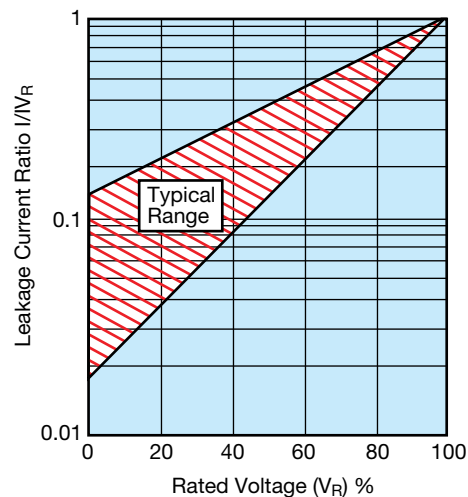

Figure 2

One final point worthy of mention with the introduction of higher reflow temperatures with the introduction of lead-free solders is that voltage derating can help to reduce the risk of failures due to thermomechanical damage during reflow.

To summarize, a tantalum capacitor is capable of being used at its rated voltage or close to it, provided that the user obeys the rules outlined in this document and is prepared for the reduced steady-state life performance and higher leakage current levels this would produce.

¹ Surge in Solid Tantalum Capacitors, John Gill, AVX Tantalum
² IR Reflow Guidelines for Tantalum Capacitors, Steve Warden & John Gill, AVX Tantalum
³ Mounting Guidelines in AVX Tantalum Catalog
⁴ Improving Reliability of Tantalum Capacitors in Low Impedance Circuits, Dave Mattingly, AVX

Question: What does failure rate mean?

Answer: Failure rate is expressed as the number of parts (as a percentage) that can be expected to fail in a given time period under specific conditions of temperature, applied voltage (ratio to rated voltage - usually 1.0) and circuit impedance.

Question: What does ppm mean?

Answer: PPM is defined as 'PARTS PER MILLION' and can be used to express how many parts within a million pieces may fail to the specification.

Question: What is the difference between %/1000hrs and FITs?

Answer: The failure rate as the mathematic quantity can be expressed in several units of measurement - mostly in %/1000hrs or in FITs. FITs are usually used for the high-reliability components where expression in %/1000hrs would be more difficult to read. The conversion is as follows: e.g. 0.01%/1000hrs = 100 FIT for specified conditions ($[\%/1000hrs] = x 10000 [FIT]$).

Question: What are the standards for reliability calculations?

Answer: The standards used in the AVX specification are based on the European norm EN 61709 with the added feature of series resistance in order to better reflect real application conditions. The basic failure rate in the AVX test is given for conditions - 85°C, Vrated, 0.1 Ohm/V. To calculate the actual failure rate for specific conditions you have to consider the influence of different factors which have an impact on reliability - correction factors for temperature (FT), voltage derating (FV), (circuit) impedance (FR) and the base failure rate (Fbase) for the series being used.

Question: Are tantalum capacitors ESD (i.e. Electrostatic Discharge) sensitive devices?

Answer: All tantalum and niobium Oxide capacitors are not ESD sensitive devices.

SPICAT - SPITAN

Contains typical measured data for the majority of AVX solid electrolytic capacitors and gives an overview of typical performance characteristic for polymer, tantalum and niobium oxide capacitors at different frequencies and temperatures. SpiCAT - SpiTAN does not contain the data from specification.

INPUT PARAMETERS

- Selected PN from the list with the help of filter (technology, capacitance, rated voltage, case, series, tolerance)

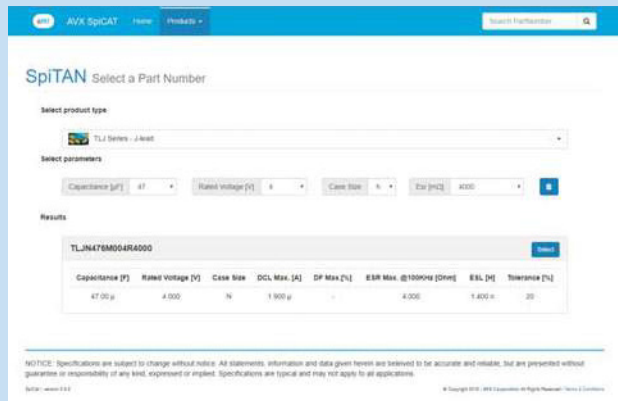

OUTPUT PARAMETERS

- Frequency characteristics of capacitance, impedance, ESR, DF for 25°C
- Temperature – shows performance according to selected operating temperature
- Frequency settings – shows values for given frequency
- Menu graph – shows additional performance figures for ripple characteristics (I,V), typical DCL performance within 5 min

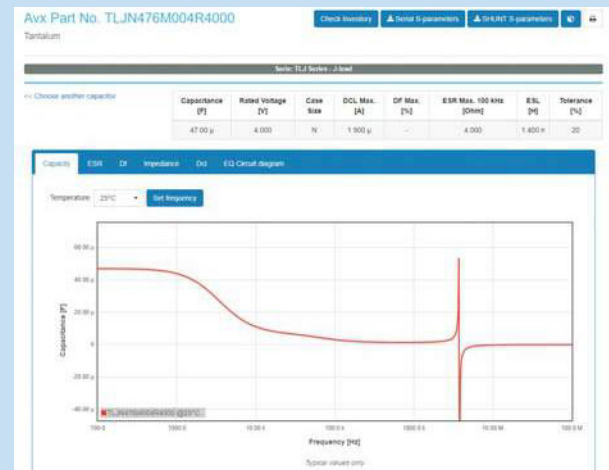

3D MODELS

3D Models support the design process and allow imagination of the PCB board component layout in 3D environment. The majority of AVX solid electrolytics case sizes are available in STEP format (Standard for the Exchange of Product Model Data).

PASSIVES

Capacitors

- Multilayer Ceramic
- Film
- Glass
- Niobium Oxide* - OxiCap[®]
- Pulse Supercapacitors
- Tantalum

Circuit Protection

- Thermistors
- Fuses - Thin Film
- Transient Voltage Suppressors
- Varistors - Zinc Oxide

Directional Couplers

- Thin-Film

Filters

- Ceramic
- EMI
- Noise
- SAW
- Low Pass - Thin Film

Inductors

- Thin-Film

Integrated Passive Components

- PMC - Thin-Film Networks
- Capacitor Arrays
- Feedthru Arrays
- Low Inductance Decoupling Arrays

Piezo Acoustic Generators

- Ceramic

Resistors

- Arrays
- Miniature Axials

Timing Devices

- Clock Oscillators
- MHz Quartz Crystal Resonators
- VCO
- TCXO

CONNECTORS

Automotive

- Standard, Custom

Board to Board

- SMD (0.4, 0.5, 1.0mm), BGA, Thru-Hole

Card Edge

DIN41612

- Standard, Inverse, High Temperature

FFC/FPC

- 0.3, 0.5, 1.0mm

Hand Held, Cellular

- Battery, I/O, SIMcard, RF shield clips

2mm Hard Metric

- Standard, Reduced Cross-Talk

IDC Wire to Board

- Headers, Plugs, Assemblies

Memory

- PCMCIA, Compact Flash, Secure Digital, MMC, Smartcard, SODIMM

Military

- H Government, DIN41612

Polytect[™]

- Soft Molding

Rack and Panel

- Varicon[™]

**For more information please visit
our website at
<http://www.avx.com>**

NOTICE: Specifications are subject to change without notice. Contact your nearest AVX Sales Office for the latest specifications. All statements, information and data given herein are believed to be accurate and reliable, but are presented without guarantee, warranty, or responsibility of any kind, expressed or implied. Statements or suggestions concerning possible use of our products are made without representation or warranty that any such use is free of patent infringement and are not recommendations to infringe any patent. The user should not assume that all safety measures are indicated or that other measures may not be required. Specifications are typical and may not apply to all applications.

© AVX Corporation

"Niobium Oxide Capacitors are manufactured and sold under patent license from Cabot Corporation, Boyertown, Pennsylvania U.S.A."

SAMPLE WALLETS:

Number of pieces per PN: 5

Number of PN's: 30

ORANGE

OxiCap®
NOJ
 (Sample Kit: NOJ)
NOS, NOM
 (Sample Kit: NOS, NOM)



BLUE

TAJ Auto, TPS Auto, THJ, TRJ (Sample Kit: Automotive)
TAJ (Sample Kit: TAJ)
TPS (Sample Kit: TPS)
THJ (Sample Kit: Hi Temp THJ)
TRJ, TRM (Sample Kit: Industrial TRJ, TRM)
TPS, TPM (Sample Kit: Low ESR)
NOS, TPM, TPS, NOM (Sample Kit: Power Supply)
TPM (Sample Kit: TPM)
TAC (Sample Kit: TAC)



GREEN

Military and HI-REL Capacitors CWR19, CWR29, CWR15 and various COTS+ products available only through the Sales or Marketing channels



BLACK

Overview of our product series and matrixes
 (Kit - Series)



PALE GREY

TLJ
 (Sample Kit: TLJ Low Profile)

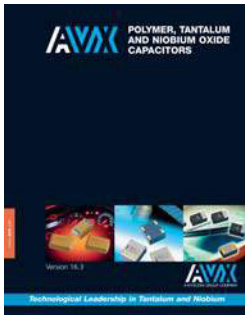

CATALOG
Polymer, Tantalum and Niobium Oxide Capacitors
 (TANT-NBO-CATALOG)

SILVER

TCJ, TAJ low, TLC, NOJ, TLJ, TLN, F38, F98
 (Sample Kit: Mobile)



YELLOW

TCJ Voltage 2V-20V
 (Sample Kit: TCJ)
TCJ HiV Voltage 25V-125V
 (Sample Kit: TCJHIV)
J-CAP™
 (Sample Kit: J-CAP)
TCQ
 (Sample Kit: TCQ)



FOLLOW US:     

VISIT US AT WWW.AVX.COM 



North America

Tel: +1 864-967-2150

Europe

Tel: +44 1276-697000

Asia

Tel: +65 6286-7555

Central America

Tel: +55 11-46881960

Japan

Tel: +81 740-321250