

DO NOT SCALE FROM THIS PRINT

NOTES:

1. REPRESENTS A CRITICAL DIMENSION.
2. BURR ALLOWANCE: .0015[.038] MAX.
3. LATCH RETENTION FORCE: 1.000LB[4.45N].
4. POSITION 2 THRU 6 TO BE IN BULK PACKING, ALL OTHER SIZES TO BE IN TUBES.
5. GATE PADS ARE RECESSED, LOCATION IS AT MOLDERS DISCRETION.
6. NYLON MATERIALS ARE HYGROSCOPIC. PRODUCT MAY EXPAND UP TO 0.5% DEPENDING ON CONDITIONS OF THE SURROUNDING ENVIRONMENT. ALL PRINT DIMENSIONS REPRESENT "DRY AS MOLDED" STATE.

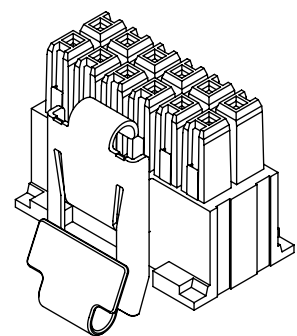
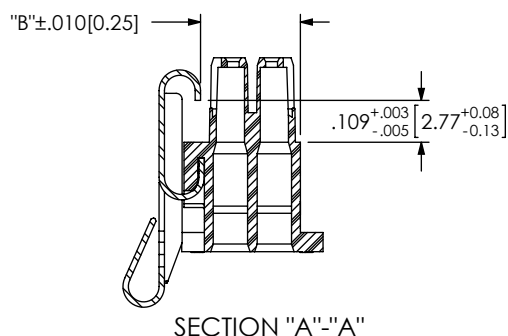
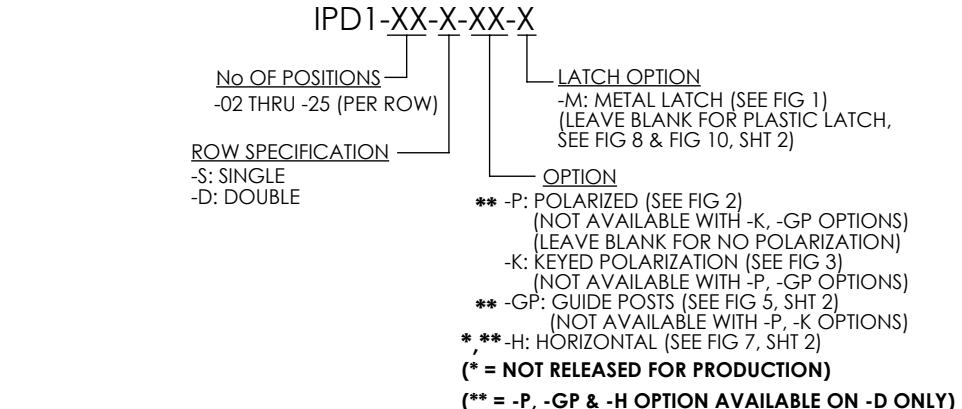
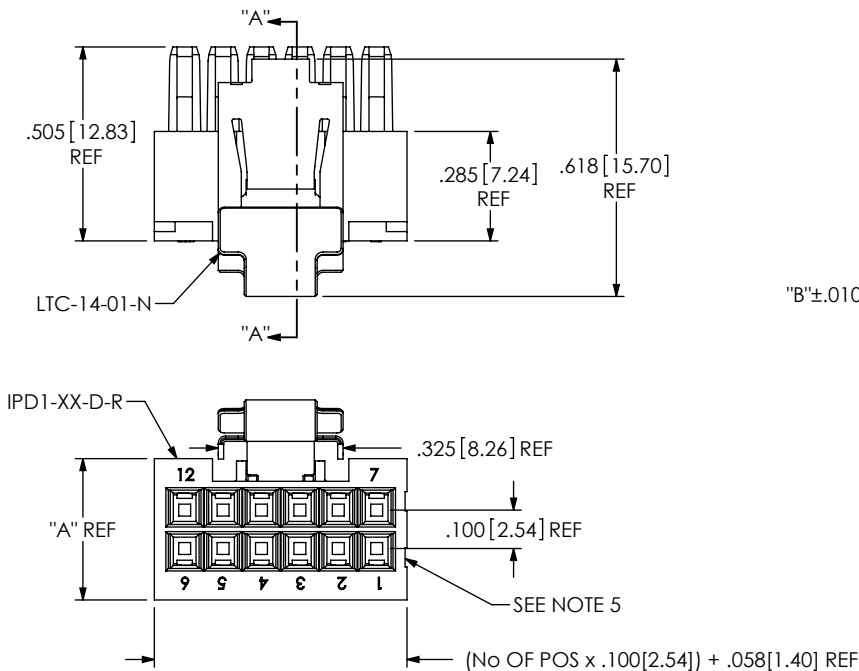
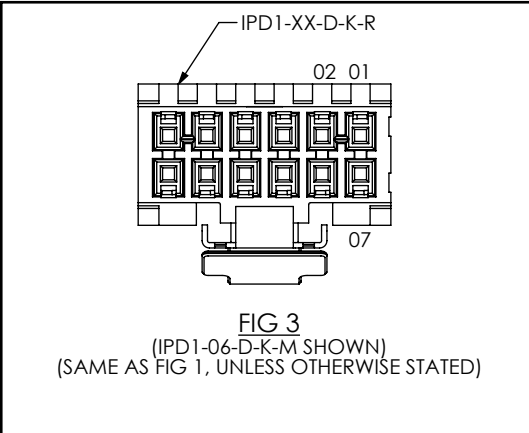
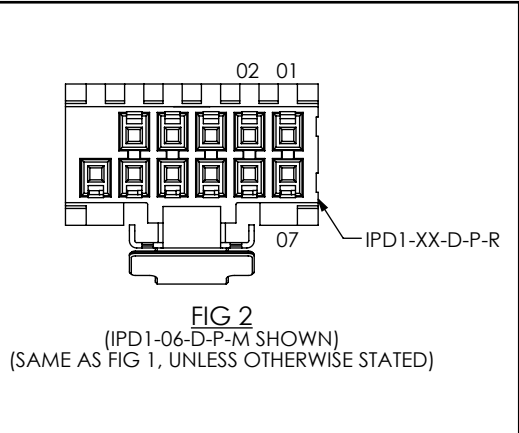

TABLE 1

ROW SPECS	"A"	"B"	"C"	"D"
-S	.300 [7.62]	.210 [5.33]	.213 [5.41]	.403 [10.24]
-D	.353 [8.97]	.260 [6.60]	.267 [6.77]	.451 [11.46]

FIG 1 (IPD1-06-D-M SHOWN)



UNLESS OTHERWISE SPECIFIED, DIMENSIONS ARE IN INCHES. TOLERANCES ARE:
 DECIMALS ANGLES
 .XX: ±.01 [.3] 2°
 .XXX: ±.005 [.13]
 .XXXX: ±.0020 [.051]

PROPRIETARY NOTE
 THIS DOCUMENT CONTAINS CONFIDENTIAL AND PROPRIETARY INFORMATION AND ALL DESIGN, MANUFACTURING, REPRODUCTION, USE, PATENT RIGHTS AND SALES RIGHTS ARE EXPRESSLY RESERVED BY SAMTEC, INC. THIS DOCUMENT SHALL NOT BE DISCLOSED, IN WHOLE OR PART, TO ANY UNAUTHORIZED PERSON OR ENTITY NOR REPRODUCED, TRANSFERRED OR INCORPORATED IN ANY OTHER PROJECT IN ANY MANNER WITHOUT THE EXPRESS WRITTEN CONSENT OF SAMTEC, INC.

520 PARK EAST BLVD, NEW ALBANY, IN 47150
 PHONE: 812-944-6733 FAX: 812-948-5047
 e-Mail: info@SAMTEC.com code 55322

MATERIAL: DO NOT SCALE DRAWING SHEET SCALE: 2:1
 INSULATOR: NYLON, UL 94 V0
 LATCH: NICKEL-PLATED BeCu, #25, 1/2 HT

DESCRIPTION: .100[2.54] DISCRETE WIRE INSULATOR & LATCH ASM
DWG. NO. IPD1-XX-X-XX-X
BY: T NEWTON 03/12/2008 **SHEET 1 OF 3**

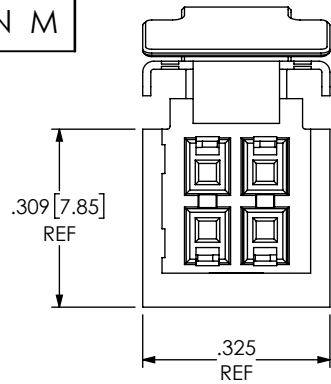

FIG 4
(IPD1-02-D-M SHOWN)
(SAME AS FIG 1, UNLESS OTHERWISE STATED)

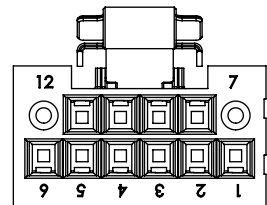
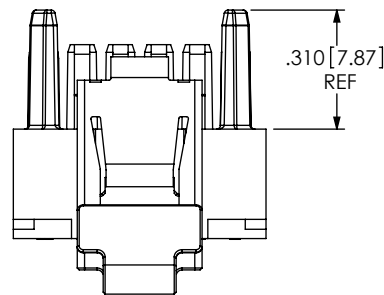
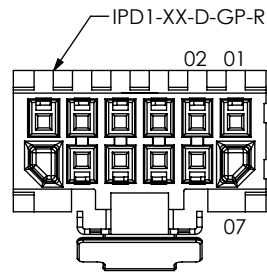

FIG 5
(IPD1-06-D-GP-M SHOWN)
(SAME AS FIG 1, UNLESS OTHERWISE STATED)

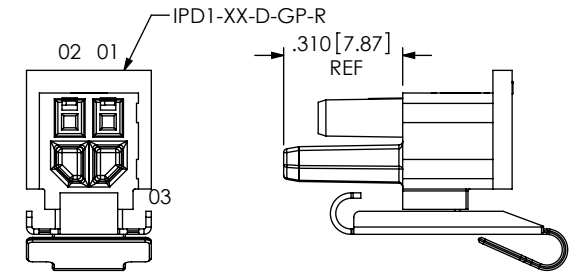

FIG 6
(IPD1-02-D-GP-M SHOWN)
(SAME AS FIG 4, UNLESS OTHERWISE STATED)

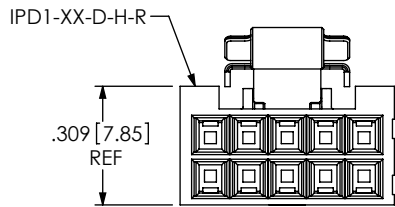
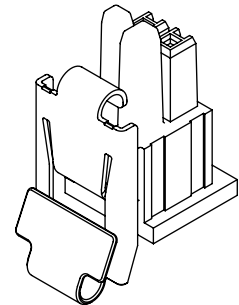
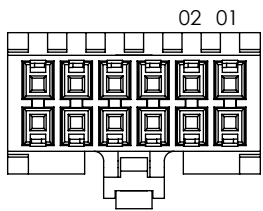
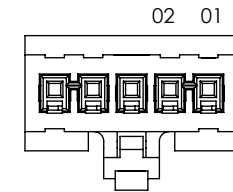
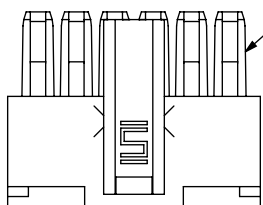

FIG 7
(IPD1-05-D-H-M SHOWN)
(SAME AS FIG 1, UNLESS OTHERWISE STATED)



"C" REF
(SEE TABLE 1, SHT 1)



.105 [2.67] REF

"D" REF
(SEE TABLE 1, SHT 1)

FIG 8
(IPD1-06-D-K SHOWN)
(SAME AS FIG 1, UNLESS OTHERWISE STATED)

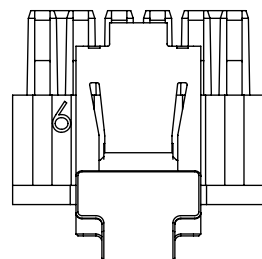
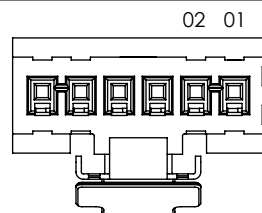

FIG 9
(IPD1-06-S-K-M SHOWN)
(SAME AS FIG 1, UNLESS OTHERWISE STATED)

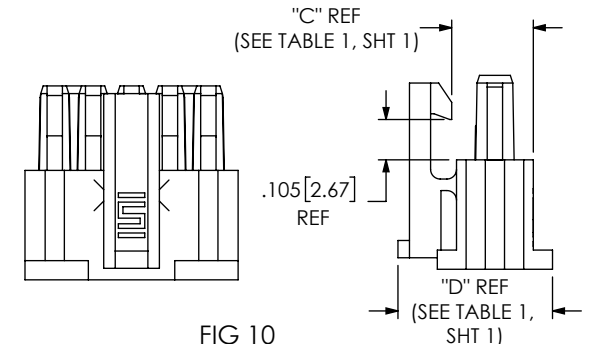

FIG 10
(IPD1-05-S-K SHOWN)
(SAME AS FIG 1, UNLESS OTHERWISE STATED)

PROPRIETARY NOTE

THIS DOCUMENT CONTAINS CONFIDENTIAL AND PROPRIETARY INFORMATION AND ALL DESIGN, MANUFACTURING, REPRODUCTION, USE, PATENT RIGHTS AND SALES RIGHTS ARE EXPRESSLY RESERVED BY SAMTEC, INC. THIS DOCUMENT SHALL NOT BE DISCLOSED, IN WHOLE OR PART, TO ANY UNAUTHORIZED PERSON OR ENTITY NOR REPRODUCED, TRANSFERRED OR INCORPORATED IN ANY OTHER PROJECT IN ANY MANNER WITHOUT THE EXPRESS WRITTEN CONSENT OF SAMTEC, INC.

DO NOT SCALE DRAWING

SHEET SCALE: 2:1

samtec

520 PARK EAST BLVD. NEW ALBANY, IN 47150
PHONE: 812-944-6733 FAX: 812-948-5047
e-Mail: info@SAMTEC.com code 55322

DESCRIPTION:
.100[2.54] DISCRETE WIRE INSULATOR & LATCH ASM

DWG. NO. IPD1-XX-X-XX-X

BY: T NEWTON 03/12/2008 SHEET 2 OF 3

TABLE 2	
No OF POS	"E"
-02	.325 [8.26]
-03	.425 [10.80]

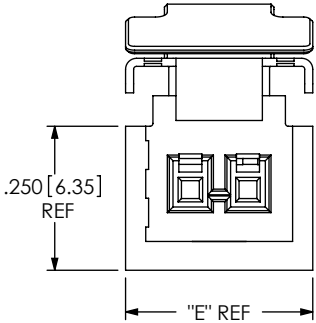
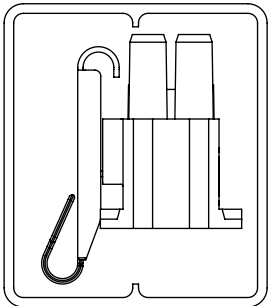
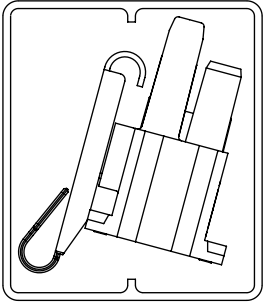

FIG 11
(IPD1-02-S-K-M SHOWN)
(SAME AS FIG 1, UNLESS OTHERWISE STATED)



-D ROW
TUBE: PT-1-24-04-56
PLUG: TP-25



-D-GP
TUBE: PT-1-24-04-56
PLUG: TP-25

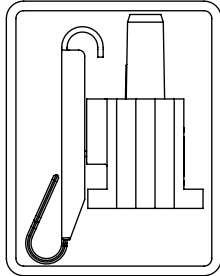

-S ROW
TUBE: PT-1-24-02-112
PLUG: TP-28

PACKAGING VIEW
(SEE NOTE 4)

PROPRIETARY NOTE
THIS DOCUMENT CONTAINS CONFIDENTIAL AND PROPRIETARY INFORMATION AND ALL DESIGN, MANUFACTURING, REPRODUCTION, USE, PATENT RIGHTS AND SALES RIGHTS ARE EXPRESSLY RESERVED BY SAMTEC, INC. THIS DOCUMENT SHALL NOT BE DISCLOSED, IN WHOLE OR PART, TO ANY UNAUTHORIZED PERSON OR ENTITY NOR REPRODUCED, TRANSFERRED OR INCORPORATED IN ANY OTHER PROJECT IN ANY MANNER WITHOUT THE EXPRESS WRITTEN CONSENT OF SAMTEC, INC.

DO NOT SCALE DRAWING

SHEET SCALE: 2.5:1



520 PARK EAST BLVD, NEW ALBANY, IN 47150
PHONE: 812-944-6733 FAX: 812-948-5047
e-Mail info@SAMTEC.com code 55322

DESCRIPTION:
.100[2.54] DISCRETE WIRE INSULATOR & LATCH ASM

DWG. NO.
IPD1-XX-X-XX-X

BY: T NEWTON 03/12/2008 SHEET 3 OF 3