

DO NOT
SCALE FROM
THIS PRINT

FOPC-XX-XX-XXX-XX-XX

- END 1**
 MTP MALE: -01
 MTP FEMALE: -02
 QSFP LOOPBACK MALE: -03
 QSFP LOOPBACK FEMALE: -04
 CXP LOOPBACK MALE: -05
 CXP LOOPBACK FEMALE: -06
- END 2***
 MTP MALE: -01
 MTP FEMALE: -02
- CONSTRUCTION***
 -01: 3mm ROUND JACKET
 -02**: ORANGE SECURE KEY MTP
 -03**: BLUE SECURE KEY MTP
- FIBERS***
 -12
 -24
- LENGTH***
 -003: 3 METERS
 -010: 10 METERS
 -100: 100 METERS
 (OTHER LENGTHS AVAILABLE AS CUSTOM PART NUMBERS)

* LEAVE BLANK FOR END 1 OPTIONS -03, -04, -05, -06
 **AVAILABLE ONLY WITH END OPTION -02 AND -24 FIBERS

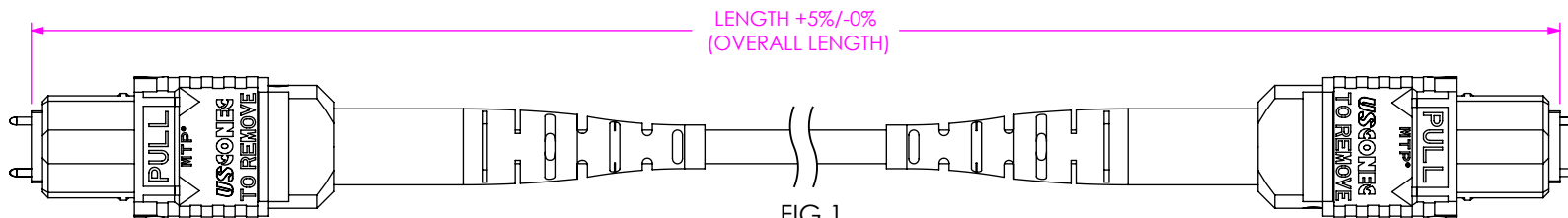

FIG 1
 FOPC-01-01-XXX-12-01 SHOWN

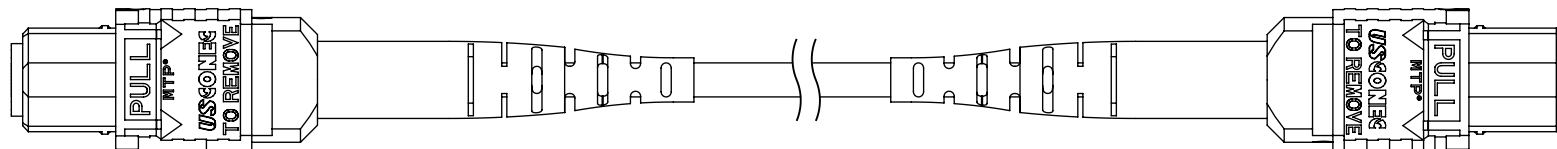

FIG 2
 FOPC-02-02-XXX-24-01 SHOWN

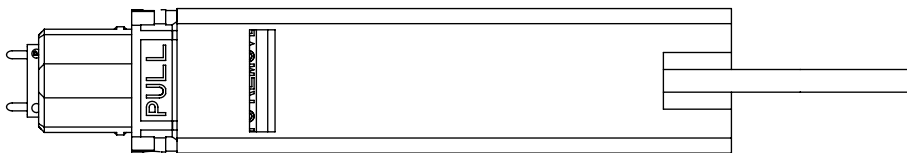

FIG3
 FOPC-03 SHOWN

TOLERANCES DO NOT APPLY TO REFERENCE DIMENSIONS, UNLESS OTHERWISE SPECIFIED, DIMENSIONS ARE IN INCHES.
 TOLERANCES ARE:
 DECIMALS ANGLES
 .XX: ±.01[.3] 2°
 .XXX: ±.005[.13]
 .XXXX: ±.0020[.051]

PROPRIETARY NOTE
 THIS DOCUMENT CONTAINS CONFIDENTIAL AND PROPRIETARY INFORMATION AND ALL DESIGN, MANUFACTURING, REPRODUCTION, USE, PATENT RIGHTS AND SALES RIGHTS ARE EXPRESSLY RESERVED BY SAMTEC, INC. THIS DOCUMENT SHALL NOT BE DISCLOSED, IN WHOLE OR PART, TO ANY UNAUTHORIZED PERSON OR ENTITY NOR REPRODUCED, TRANSFERRED OR INCORPORATED IN ANY OTHER PROJECT IN ANY MANNER WITHOUT THE EXPRESS WRITTEN CONSENT OF SAMTEC, INC.



520 PARK EAST BLVD, NEW ALBANY, IN 47150
 PHONE: 812-944-6733 FAX: 812-948-5047
 e-Mail: info@SAMTEC.com code 53322

DO NOT SCALE DRAWING SHEET SCALE: 2:3

DESCRIPTION: FIBER OPTIC PATCH CABLE

DWG. NO. FOPC-XX-XX-XXX-XX-XX

BY: JEAN W. 02/05/2015 SHEET 1 OF 4

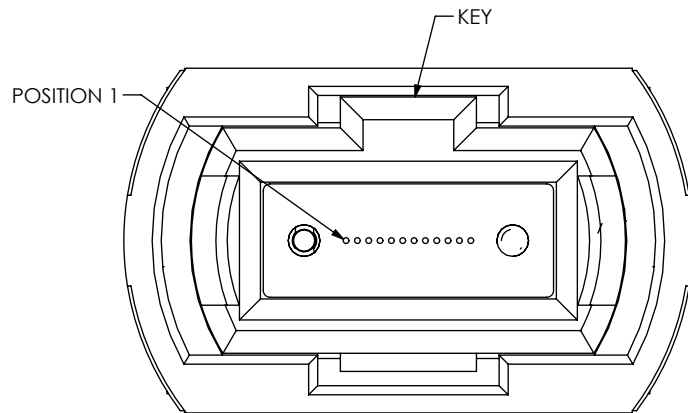

12 FIBER CONNECTOR

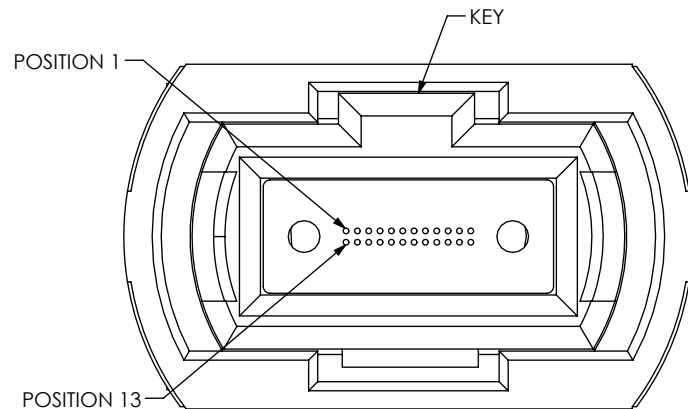

24 FIBER CONNECTOR

TABLE 2: 12 FIBER CABLE POLARITY (TYPE B)			
SIDE A POSITION	FIBER COLOR		SIDE B POSITION
1	BLUE		12
2	ORANGE		11
3	GREEN		10
4	BROWN		9
5	SLATE		8
6	WHITE		7
7	RED		6
8	BLACK		5
9	YELLOW		4
10	VIOLET		3
11	ROSE		2
12	AQUA		1

TABLE 2: 24 FIBER CABLE POLARITY (TYPE C)			
SIDE A POSITION	FIBER COLOR		SIDE B POSITION
1	BLUE		13
2	ORANGE		14
3	GREEN		15
4	BROWN		16
5	SLATE		17
6	WHITE		18
7	RED		19
8	BLACK		20
9	YELLOW		21
10	VIOLET		22
11	ROSE		23
12	AQUA		24
13	BLUE		1
14	ORANGE		2
15	GREEN		3
16	BROWN		4
17	SLATE		5
18	WHITE		6
19	RED		7
20	BLACK		8
21	YELLOW		9
22	VIOLET		10
23	ROSE		11
24	AQUA		12

NOTES:

1. ALL PATCH CABLES BUILT WITH 12 FIBERS ARE ANSI/TIA-568.3-D TYPE-B:1-1 (SEE TABLE 1)
2. ALL PATCH CABLES BUILT WITH 24 FIBERS ARE ANSI/TIA-568.3-D TYPE-A:2-2 (SEE TABLE 2)
3. EMAIL OPTICS@SAMTEC.COM FOR SPECIFIC APPLICATION INFORMATION

PROPRIETARY NOTE
 THIS DOCUMENT CONTAINS CONFIDENTIAL AND PROPRIETARY INFORMATION AND ALL DESIGN, MANUFACTURING, REPRODUCTION, USE, PATENT RIGHTS AND SALES RIGHTS ARE EXPRESSLY RESERVED BY SAMTEC, INC. THIS DOCUMENT SHALL NOT BE DISCLOSED, IN WHOLE OR PART, TO ANY UNAUTHORIZED PERSON OR ENTITY NOR REPRODUCED, TRANSFERRED OR INCORPORATED IN ANY OTHER PROJECT IN ANY MANNER WITHOUT THE EXPRESS WRITTEN CONSENT OF SAMTEC, INC.



520 PARK EAST BLVD, NEW ALBANY, IN 47150
 PHONE: 812-944-6733 FAX: 812-948-5047
 e-Mail info@SAMTEC.com code 55322





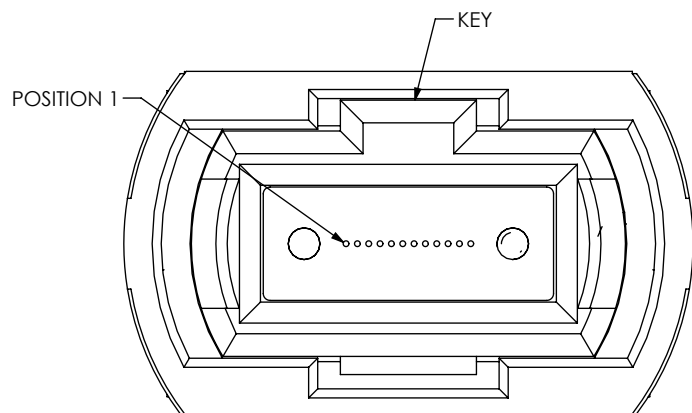

DESCRIPTION: FIBER OPTIC PATCH CABLE

DWG. NO. **FOPC-XX-XX-XXX-XX-XX**

BY: JEAN W. 02/05/2015 SHEET 2 OF 4







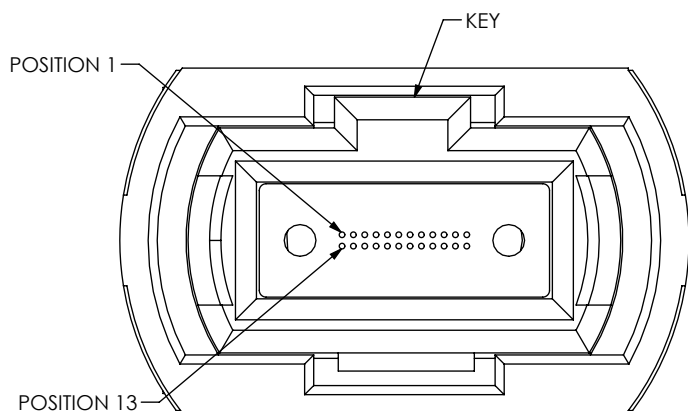







QSFP LOOPBACK

TABLE 5: QSFP LOOPBACK COLOUR CODING			
		FIBER COLOR	
1	12	BLUE	
2	11	ORANGE	
3	10	GREEN	
4	9	BROWN	
5	8	SLATE	
6	7	WHITE	



CXP / CFP LOOPBACK

TABLE 6: CXP/CFP LOOPBACK COLOUR CODING			
		FIBER COLOR	
1	13	BLUE	
2	14	ORANGE	
3	15	GREEN	
4	16	BROWN	
5	17	SLATE	
6	18	WHITE	
7	19	RED	
8	20	BLACK	
9	21	YELLOW	
10	22	VIOLET	
11	23	ROSE	
12	24	AQUA	

NOTES:

1. ALL PATCH CABLES BUILT WITH 12 FIBERS ARE ANSI/TIA-568.3-D TYPE-B:1-1 (SEE TABLE 1)
2. ALL PATCH CABLES BUILT WITH 24 FIBERS ARE ANSI/TIA-568.3-D TYPE-A:2-2 (SEE TABLE 2)
3. EMAIL OPTICS@SAMTEC.COM FOR SPECIFIC APPLICATION INFORMATION

PROPRIETARY NOTE
 THIS DOCUMENT CONTAINS CONFIDENTIAL AND PROPRIETARY INFORMATION AND ALL DESIGN, MANUFACTURING, REPRODUCTION, USE, PATENT RIGHTS AND SALES RIGHTS ARE EXPRESSLY RESERVED BY SAMTEC, INC. THIS DOCUMENT SHALL NOT BE DISCLOSED, IN WHOLE OR PART, TO ANY UNAUTHORIZED PERSON OR ENTITY NOR REPRODUCED, TRANSFERRED OR INCORPORATED IN ANY OTHER PROJECT IN ANY MANNER WITHOUT THE EXPRESS WRITTEN CONSENT OF SAMTEC, INC.

samtec

520 PARK EAST BLVD, NEW ALBANY, IN 47150
 PHONE: 812-944-6733 FAX: 812-948-5047
 e-Mail info@SAMTEC.com code 55322

DESCRIPTION: FIBER OPTIC PATCH CABLE

DWG. NO. **FOPC-XX-XX-XXX-XX-XX**

BY: JEAN W. 02/05/2015 SHEET 3 OF 4

PACKAGING VIEW

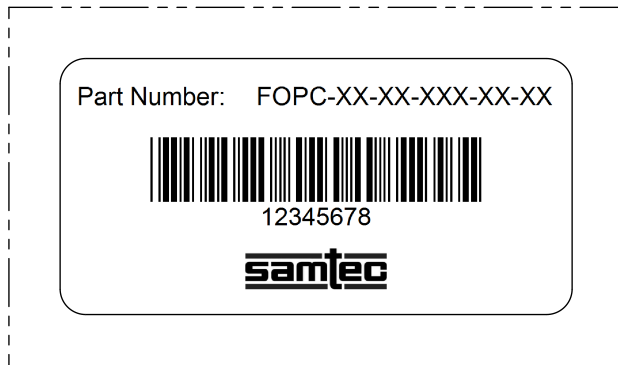
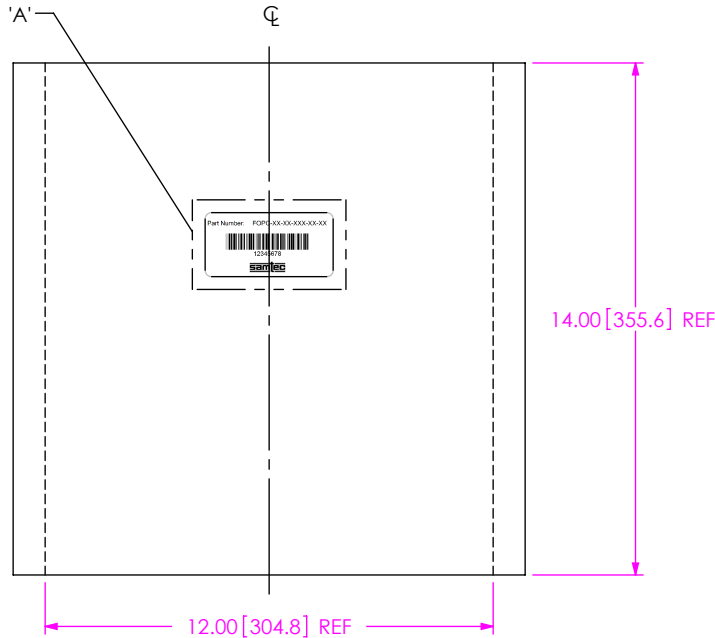

DETAIL 'A'

FIBER CABLE SPECIFICATIONS	
JACKET COLOR	AQUA
JACKET UL RATING	UL-910 OFNP
MODE	MULTIMODE
INSERTION LOSS	< 0.75 dB
RETURN LOSS	> 20 dB
OPERATING WAVELENGTH	850 nm - 1310 nm
CORE/CLADDING/BUFFER	50 μm / 125 μm / 250 μm

TABLE 3: FIBER OPTIC PATCH CABLE	
PART NUMBER	BOM ITEM
FOPC-01-01-003-12-01	CCS-187300-01-FC
FOPC-01-01-010-12-01	CCS-187300-02-FC
FOPC-01-01-100-12-01	CCS-187300-03-FC
FOPC-01-01-003-24-01	FOP-06-06-A-24-01-003.0
FOPC-01-01-010-24-01	FOP-06-06-A-24-01-010.0
FOPC-01-01-100-24-01	FOP-06-06-A-24-01-100.0
FOPC-01-02-003-12-01	CCS-185419-01-FC
FOPC-01-02-010-12-01	CCS-185419-02-FC
FOPC-01-02-100-12-01	CCS-185419-03-FC
FOPC-01-02-003-24-01	FOP-06-07-A-24-01-003.0
FOPC-01-02-010-24-01	FOP-06-07-A-24-01-010.0
FOPC-01-02-100-24-01	FOP-06-07-A-24-01-100.0
FOPC-02-01-003-12-01	CCS-185419-01-FC
FOPC-02-01-010-12-01	CCS-185419-02-FC
FOPC-02-01-100-12-01	CCS-185419-03-FC
FOPC-02-01-003-24-01	FOP-06-07-A-24-01-003.0
FOPC-02-01-010-24-01	FOP-06-07-A-24-01-010.0
FOPC-02-01-100-24-01	FOP-06-07-A-24-01-100.0
FOPC-02-02-003-12-01	CCS-187303-01-FC
FOPC-02-02-010-12-01	CCS-187303-02-FC
FOPC-02-02-100-12-01	CCS-187303-03-FC
FOPC-02-02-003-24-01	FOP-07-07-A-24-01-003.0
FOPC-02-02-010-24-01	FOP-07-07-A-24-01-010.0
FOPC-02-02-100-24-01	FOP-07-07-A-24-01-100.0
FOPC-02-02-003-24-02	CCS-192313-03-FC
FOPC-02-02-010-24-02	CCS-192313-05-FC
FOPC-02-02-100-24-02	CCS-192313-04-FC
FOPC-02-02-003-24-03	CCS-192314-03-FC
FOPC-02-02-010-24-03	CCS-192314-05-FC
FOPC-02-02-100-24-03	CCS-192314-14-FC
FOPC-03	QSFP-MTP-LOOPBACK-OM3-M
FOPC-04	QSFP-MTP-LOOPBACK-OM3-F
FOPC-05	MTP-24-LOOPBACK-OM3-M
FOPC-06	MTP-24-LOOPBACK-OM3-F

TABLE 4: BOM					
ITEM	PART NUMBER	DESCRIPTION	QTY	COST QTY	UOM
1	SEE TABLE 3	FIBER OPTIC PATCH CABLE	1	1	EACH
2	SSBAG-12X14-AS	PACKAGING BAG	1	1	EACH
3	LABEL-4X2	LABEL	1/3000	1/3000	EACH

PROPRIETARY NOTE
 THIS DOCUMENT CONTAINS CONFIDENTIAL AND PROPRIETARY INFORMATION AND ALL DESIGN, MANUFACTURING, REPRODUCTION, USE, PATENT RIGHTS AND SALES RIGHTS ARE EXPRESSLY RESERVED BY SAMTEC, INC. THIS DOCUMENT SHALL NOT BE DISCLOSED, IN WHOLE OR PART, TO ANY UNAUTHORIZED PERSON OR ENTITY NOR REPRODUCED, TRANSFERRED OR INCORPORATED IN ANY OTHER PROJECT IN ANY MANNER WITHOUT THE EXPRESS WRITTEN CONSENT OF SAMTEC, INC.



520 PARK EAST BLVD, NEW ALBANY, IN 47150
 PHONE: 812-944-6733 FAX: 812-948-5047
 e-Mail info@SAMTEC.com code 53322

DESCRIPTION: FIBER OPTIC PATCH CABLE
 DWG. NO. FOPC-XX-XX-XXX-XX-XX
 BY: JEAN W. 02/05/2015 SHEET 4 OF 4