

REVISIONS					
P	LTR	DESCRIPTION	DATE	DWN	APVD
	BA	NEW DRAWING	18MAY2020	SR	AP

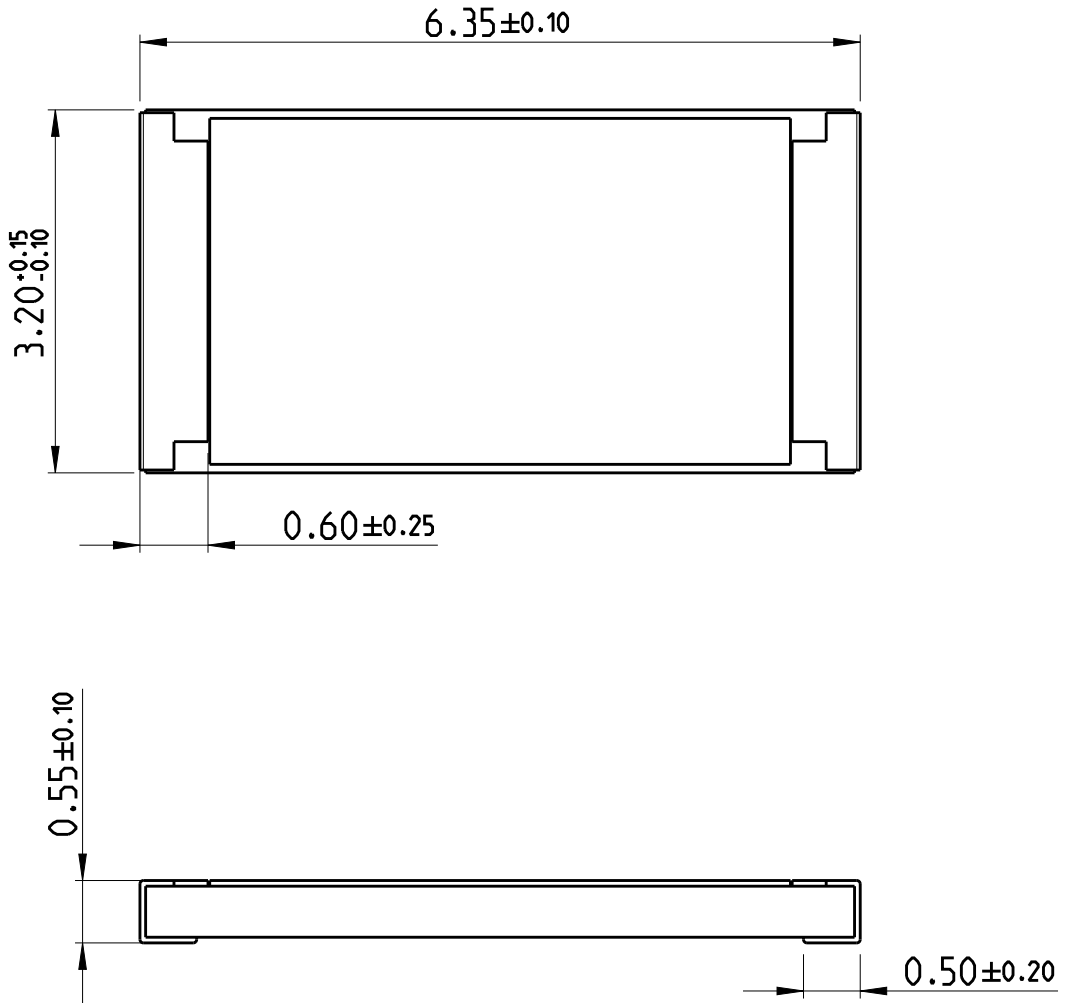

FOR FURTHER INFORMATION SEE PRODUCT SPECIFICATION FOR CRGV SERIES

RoHS Compliant

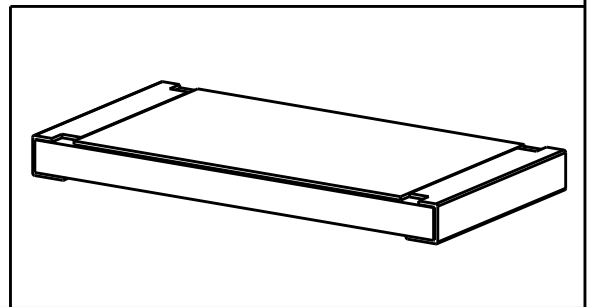

© 2020 TE Connectivity. All Rights Reserved.

DIMENSIONS: mm	DWN SUPREETH R	18MAY2020	MATERIAL	-	FINISH	-
	CHK ALLAN P	18MAY2020				
TOLERANCES UNLESS OTHERWISE SPECIFIED:	APVD ALLAN P	18MAY2020				
	PRODUCT SPEC	-	NAME	HIGH VOLTAGE THICK FILM CHIP RESISTORS - TYPE CRGV2512 SERIES		
	APPLICATION SPEC	-	SIZE	CAGE CODE	DRAWING NO	RESTRICTED TO
0 PLC ±	WEIGHT	-	A4	00779	C-1879539	-
1 PLC ±0.5	CUSTOMER DRAWING		SCALE	15:1	SHEET	1 OF 1
2 PLC ±0.13			REV	BA		
3 PLC ±0.013						
4 PLC ±0.0001						
ANGLES ±						

