

CKT NO	PART NO	DIM A
2	170001-0102	8.35
4	170001-0104	12.05
6	170001-0106	17.75
8	170001-0108	23.45 ^{+0.40} / _{-0.25}
10	170001-0110	29.15 ^{+0.40} / _{-0.25}
12	170001-0112	34.85 ^{+0.40} / _{-0.25}

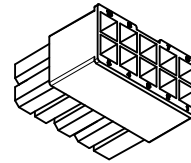

170001-0110

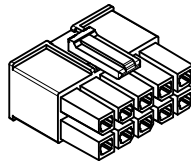
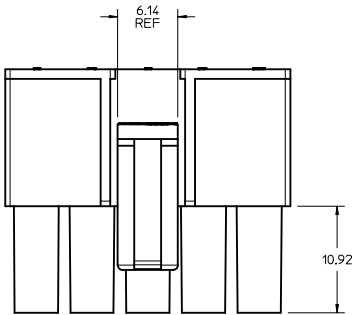
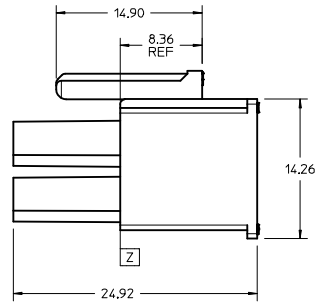
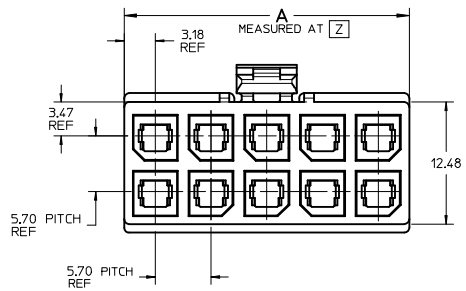

NOTES:

1. MATERIAL:
HOUSING: NYLON, GLOW WIRE CAPABLE PER IEC-60335-1, COLOR: BLACK.
2. PRODUCT SPECIFICATION PS-76823-100.
3. PART MATES WITH MOLEX SERIES NUMBER 76825, 172064 AND 76829, 172065.
4. PART IS FOR USE WITH MOLEX FEMALE TERMINALS 76823 OR 172063 SERIES.
5. PART IS NOT DESIGNED FOR CURRENT SHARING.
6. PARTS CONFORM TO CLASS "B" REQUIREMENTS OF COSMETIC SPECIFICATION PS-45499-002 WITH THE EXCEPTION OF DISCOLORATION MEET CLASS "C" REQUIREMENTS.
7. PACKAGING BULK PACK PER PK-170001-001.

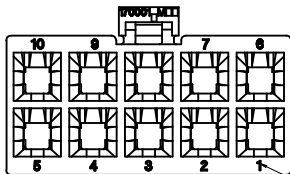
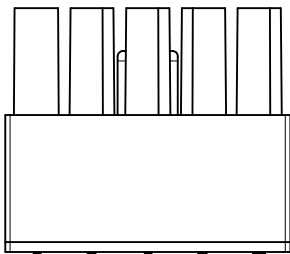

CIRCUIT #

REVISE NOTES IEC NO: UCP2014-0568 DRAWN: SCHAEFER CHYD: APPROV: APATEL APPR: APATEL 2013/08/05 2013/08/16	QUALITY SYMBOLS ∇=0 ∇=0 ∇=0	GENERAL TOLERANCES (UNLESS SPECIFIED)		DIMENSION STYLE MM ONLY	SCALE 4:1	DESIGN UNITS METRIC	THIRD ANGLE PROJECTION		
		4 PLACES ±--- 3 PLACES ±--- 2 PLACES ±0.25 1 PLACE ±--- 0 PLACE ±	mm INCH	DRAWN BY MKARADIMAS	DATE 2010/11/23	TITLE MEGA-FIT RECEPTACLE HOUSING 2-12 CKT			
		DRAFT WHERE APPLICABLE MUST REMAIN WITHIN DIMENSIONS		APPROVED BY APATEL	DATE 2012/06/13	MATERIAL NO. SEE CHART			
				DOCUMENT NO. SD-170001-0100		SHEET NO. 1 OF 2			

20 19 18 17 16 15 14 13 12 11 10 9 8 7 6 5 4 3 2 1

2 CKTS

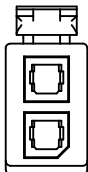

4 CKT

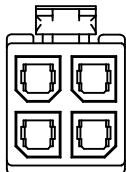

6 CKT

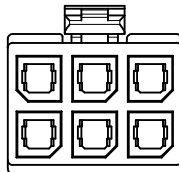

8 CKT

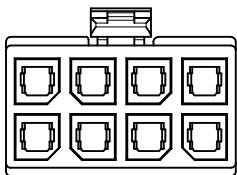

10 CKTS

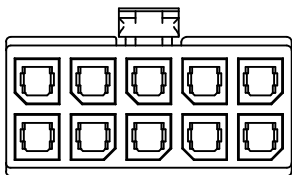

12 CKTS

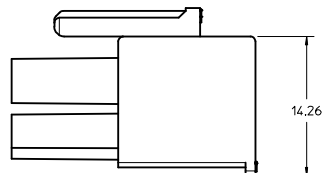
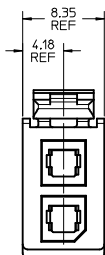
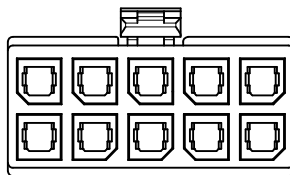

170001-0102

SEE SHT 1 IEC NO: UCF2014-0588 DRAWN: SCHAEFER CHKD: A7 APPR: APATEL 2013/08/16	QUALITY SYMBOLS	GENERAL TOLERANCES (UNLESS SPECIFIED)	DIMENSION STYLE	SCALE	DESIGN UNITS	THIRD ANGLE PROJECTION
	▽=0	4 PLACES ±	MM ONLY	4:1	METRIC	☉
	▽=0	3 PLACES ±				
	▽=0	2 PLACES ±0.25				
		1 PLACE ±				
		0 PLACE ±				
		ANGULAR ±1/2°				
		DRAFT WHERE APPLICABLE MUST REMAIN WITHIN DIMENSIONS				
			MATERIAL NO.	APPROVED BY	DATE	
			SEE CHART	APATEL	2012/06/13	
			DOCUMENT NO.			
			SD-170001-0100			
						SHEET NO. 2 OF 2
						THIS DRAWING CONTAINS INFORMATION THAT IS PROPRIETARY TO MOLEX INCORPORATED AND SHOULD NOT BE USED WITHOUT WRITTEN PERMISSION

19 18 17 16 15 14 13 12 11 10 9 8 7 6 5 4 3 2 1

CKT NO	PART NO	DIM A
2	171692-0102	8.35
4	171692-0104	12.05
6	171692-0106	17.75
8	171692-0108	23.45 +0.40
10	171692-0110	29.15 +0.40
12	171692-0112	34.85 +0.40

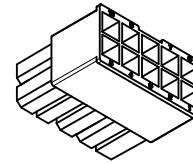
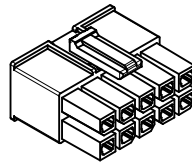
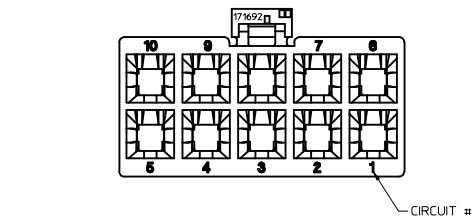
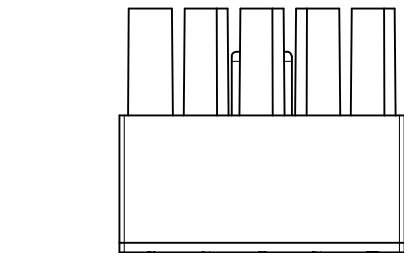
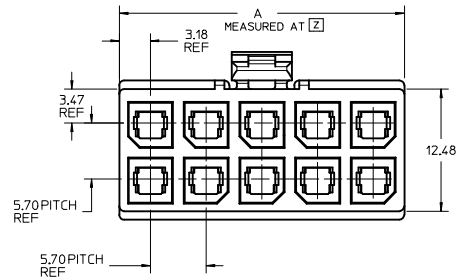
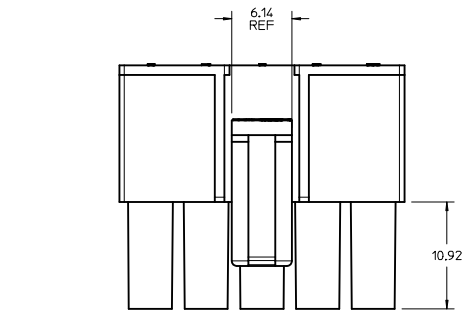

171692-0110

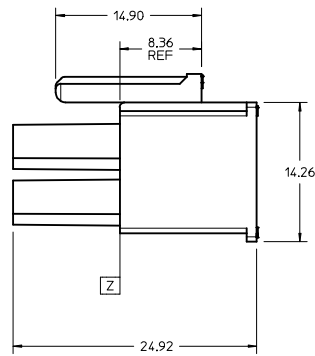

NOTES:

- MATERIAL:
HOUSING: PBT, UL 94V-0, COLOR: BLACK
- PRODUCT SPECIFICATION: PS-76823-100.
- PART MATES WITH MOLEX SERIES NUMBERS 76825, 76829, 172064, AND 172065.
- PART IS FOR USE WITH MOLEX FEMALE TERMINAL 76823 OR 172063 SERIES.
- PARTS CONFORM TO CLASS B REQUIREMENTS OF COSMETIC SPECIFICATION PS-45499-002.
- PACKAGING: BULK PACK PER PK-170001-001.

UPDATE MATERIAL IEC NO: UCP2014-0527 DRAWN BY: DRWANNANUVEN CHECKED BY: CHKD.BELL APPROVED BY: APPRESMITH DATE: 2013/09/17 DATE: 2013/09/23 REV: A5	QUALITY SYMBOLS	GENERAL TOLERANCES (UNLESS SPECIFIED)	DIMENSION STYLE	SCALE	DESIGN UNITS	THIRD ANGLE PROJECTION
	▽=0	mm	MM ONLY	4:1	METRIC	
	▽=0	INCH	4 PLACES ±.005	DRAWN BY: MKARADIMAS	DATE: 2012/08/01	TITLE: MEGA-FIT RECEPTACLE HOUSING 2-12 CKT
	▽=0	ANGULAR ±1/2°	3 PLACES ±.010	CHECKED BY: A.PATEL	DATE: 2012/08/17	
		DRAFT WHERE APPLICABLE MUST REMAIN WITHIN DIMENSIONS	APPROVED BY: APATEL	DATE: 2012/08/17	MATERIAL NO. SEE CHART	DOCUMENT NO. SD-171692-0100
			SIZE D	THIS DRAWING CONTAINS INFORMATION THAT IS PROPRIETARY TO MOLEX INCORPORATED AND SHOULD NOT BE USED WITHOUT WRITTEN PERMISSION		SHEET NO. 1 OF 2

20 19 18 17 16 15 14 13 12 11 10 9 8 7 6 5 4 3 2 1

2 CKTS

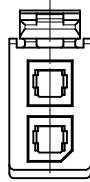

4 CKT

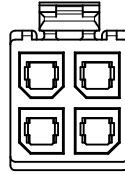

6 CKT

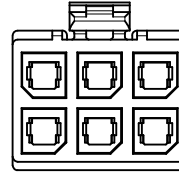

8 CKT

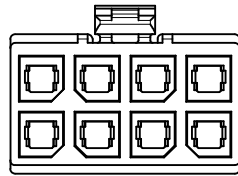

10 CKTS

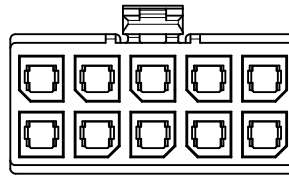

12 CKTS

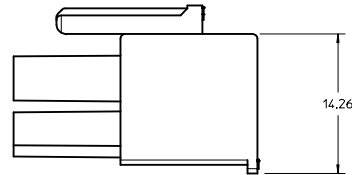
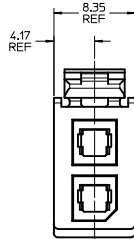
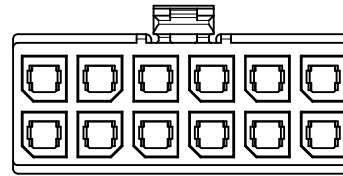

171692-0102

SEE SHT 1 IEC NO: UCP2014-0527 DRAWING NO: 2013/09/17 CHYK:J.BELL APPR:FSM TH 2013/09/23	QUALITY SYMBOLS ▽=0 ▽=0 ▽=0	GENERAL TOLERANCES (UNLESS SPECIFIED)		DIMENSION STYLE MM ONLY	SCALE 4:1	DESIGN UNITS METRIC	THIRD ANGLE PROJECTION
		4 PLACES ±--- ±--- 3 PLACES ±--- ±--- 2 PLACES ±0.25 ±--- 1 PLACE ±--- ±--- 0 PLACE ±--- ±---	mm INCH	DRAWN BY MKARADIMAS	DATE 2012/08/01	TITLE MEGA-FIT RECEPTACLE HOUSING 2-12 CKT	
DRAFT WHERE APPLICABLE MUST REMAIN WITHIN DIMENSIONS		ANGULAR ±1/2°		MATERIAL NO. SEE CHART	APPROVED BY APATEL	DATE 2012/08/17	DOCUMENT NO. SD-171692-0100
THIS DRAWING CONTAINS INFORMATION THAT IS PROPRIETARY TO MOLEX INCORPORATED AND SHOULD NOT BE USED WITHOUT WRITTEN PERMISSION							SHEET NO. 2 OF 2

19 18 17 16 15 14 13 12 11 10 9 8 7 6 5 4 3 2 1