

注記  
NOTES

- 材質  
ウエハー: 耐熱性ナイロン UL94V-0  
ピン: 銅合金、ニッケル下地、錫メッキ、金メッキ  
フィッティングネイル: 銅合金、ニッケル下地、錫メッキ  
MATERIAL  
WAFER: POLYAMIDE UL94V-0  
PIN: COPPER ALLOY, GOLD OR TIN OVER NICKEL PLATE.  
FINNING NAIL: COPPER ALLOY, TIN OVER NICKEL PLATE.
- 色: ナチュラル  
COLOR: NATURAL
- 嵌合相手:  
ハウジング: 502351-\*\*00  
錫メッキ端子: 50212-8\*00, 50372-8\*00, 560085-0101  
金メッキ端子: 56161-8\*81  
MATES WITH  
HOUSING: 502351-\*\*00  
SN PLATING TERMINAL: 50212-8\*00, 50372-8\*00, 560085-0101  
AU PLATING TERMINAL: 56161-8\*81
- エンボス梱包品の詳細はSD-560020-002参照  
DETAILED TAPING PACKAGE, SEE SD-560020-002
- ELV及びRoHS適合  
ELV AND RoHS COMPLIANT
- 半田付け面のコプラナリティ: 0.1mm MAX.  
CO-PLANARITY OF SOLDER TAILS TO BE 0.1mm MAX.

REVISED EC NO.: JTR2015-0031 DRAWN: KINAGA102 2014/10/02 CHKD: HKOMATSU 2014/10/02 APPR: MAYAMOTO 2014/10/15	GENERAL TOLERANCES (UNLESS SPECIFIED)		DIMENSION STYLE MM ONLY	SCALE 5:1	DESIGN UNITS METRIC	THIRD ANGLE PROJECTION
	10 UNDER	±0.2	DRAWN BY SHSHIBATA	DATE 2009/02/18	TITLE 2.0MM PITCH W/B CONN. WAFER ASSY ST. SMT	
	10 OVER 30 UNDER	±0.25	CHECKED BY HKOMATSU	DATE 2009/02/18		
	30 OVER	±0.3	APPROVED BY AKANESHI GE	DATE 2009/02/18		
ANGULAR	±1°	DRAFT WHERE APPLICABLE MUST REMAIN WITHIN DIMENSIONS		MATERIAL NO. SEE CHART	DOCUMENT NO. SD-560020-001	SHEET NO. 1 OF 3
SIZE A3	THIS DRAWING CONTAINS INFORMATION THAT IS PROPRIETARY TO MOLEX INCORPORATED AND SHOULD NOT BE USED WITHOUT WRITTEN PERMISSION					

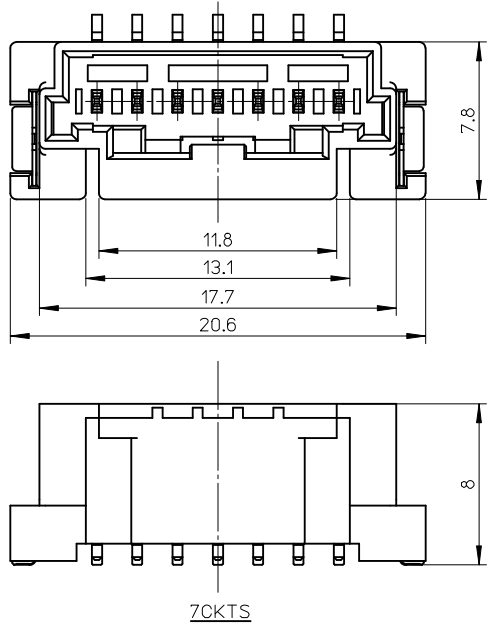
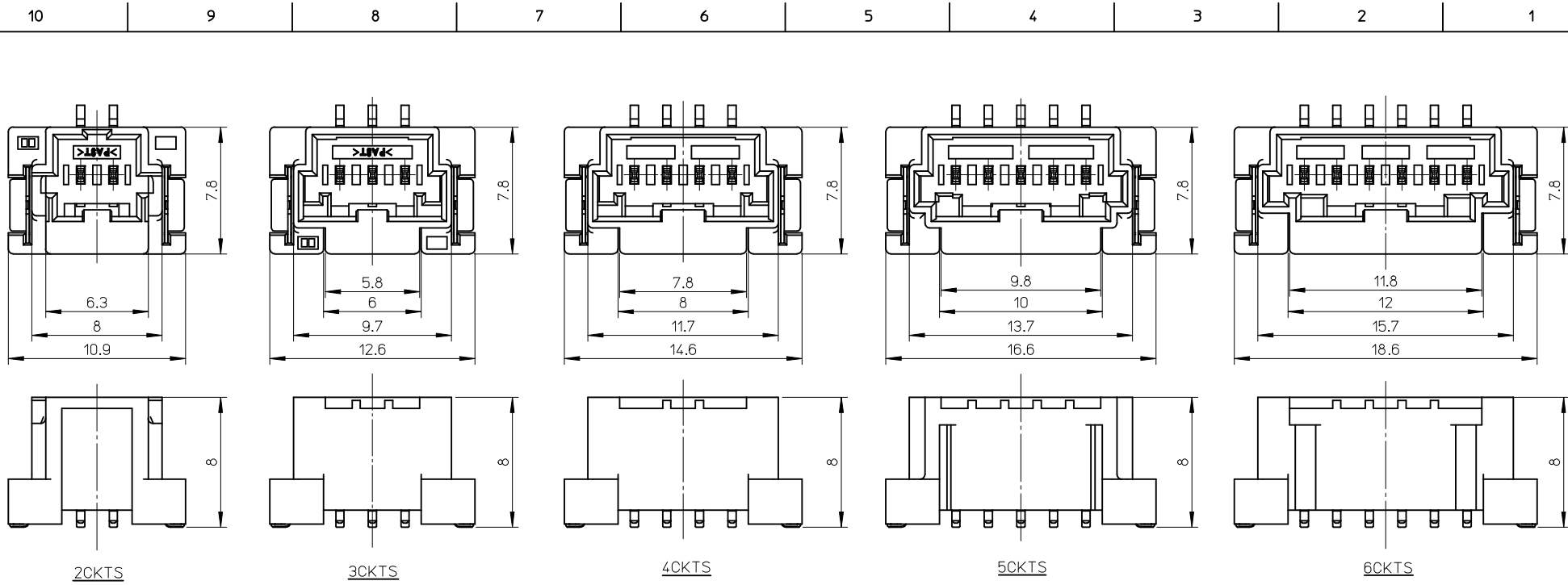

REVISED EC NO: JTR2015-0031 DRWN:KAGAI02 2014/10/02 CHKD:HKOMATSU 2014/10/02 APPR: MAYAMOTO 2014/10/15	GENERAL TOLERANCES (UNLESS SPECIFIED)		DIMENSION STYLE MM ONLY	SCALE 4:1	DESIGN UNITS METRIC	THIRD ANGLE PROJECTION
	10 UNDER	±0.2	DRAWN BY SHSHIBATA	DATE 2009/02/18	TITLE 2.0MM PITCH W/B CONN. WAFER ASSY ST. SMT	
	10 OVER 30 UNDER	±0.25	CHECKED BY HKOMATSU	DATE 2009/02/18		
	30 OVER	±0.3	APPROVED BY AKANESHIGE	DATE 2009/02/18	<b>molex</b> DOCUMENT NO. SD-560020-001 SHEET NO. 2 OF 3	
ANGULAR ±1°		MATERIAL NO. SEE CHART				
DRAFT WHERE APPLICABLE MUST REMAIN WITHIN DIMENSIONS		SIZE A3		THIS DRAWING CONTAINS INFORMATION THAT IS PROPRIETARY TO MOLEX INCORPORATED AND SHOULD NOT BE USED WITHOUT WRITTEN PERMISSION		

	10	9	8	7		
F	Sn					
	11.8	15.1	19.7	22.6	560020-0800/-0820	8
	11.8	13.1	17.7	20.6	560020-0700/-0720	7
	11.8	12	15.7	18.6	560020-0600/-0620	6
	9.8	10	13.7	16.6	560020-0500/-0520	5
	7.8	8	11.7	14.6	560020-0400/-0420	4
	5.8	6	9.7	12.6	560020-0300/-0320	3
	6.3		8.0	10.9	560020-0200/-0220	2
PLATING	D	C	B	A	EMBOSSED PACKAGE ORDER NO.	CKTS
CONNECTOR SERIES NO. 560020-**08						

	6	5	4	3	2	1
F	Au					
	11.8	15.1	19.7	22.6	560020-0830	8
	11.8	13.1	17.7	20.6	560020-0730	7
	11.8	12	15.7	18.6	560020-0630	6
	9.8	10	13.7	16.6	560020-0530	5
	7.8	8	11.7	14.6	560020-0430	4
	5.8	6	9.7	12.6	560020-0330	3
	6.3		8.0	10.9	560020-0230	2
PLATING	D	C	B	A	EMBOSSED PACKAGE ORDER NO.	CKTS
CONNECTOR SERIES NO. 560020-**18						

D						
C						
B						
A						

D						
C						
B						
A						

REVISED EC NO: JTR2015-0031 DRW:KNAGA 102 2014/10/02 CHKD:HKOMATSU 2014/10/02 APPR: MAYAMOTO 2014/10/15	GENERAL TOLERANCES (UNLESS SPECIFIED)		DIMENSION STYLE MM ONLY		SCALE 5:1	DESIGN UNITS METRIC	THIRD ANGLE PROJECTION	
	10 UNDER	±0.2	DRAWN BY SHSHIBATA	DATE 2009/02/18	TITLE 2.0MM PITCH W/B CONN. WAFER ASSY ST. SMT			
	10 OVER 30 UNDER	±0.25	CHECKED BY HKOMATSU	DATE 2009/02/18				
	30 OVER	±0.3	APPROVED BY AKANESHIGE	DATE 2009/02/18	 DOCUMENT NO. SD-560020-001 SHEET NO. 3 OF 3			
ANGULAR ±1 °		MATERIAL NO. SEE CHART						
DRAFT WHERE APPLICABLE MUST REMAIN WITHIN DIMENSIONS		THIS DRAWING CONTAINS INFORMATION THAT IS PROPRIETARY TO MOLEX INCORPORATED AND SHOULD NOT BE USED WITHOUT WRITTEN PERMISSION						

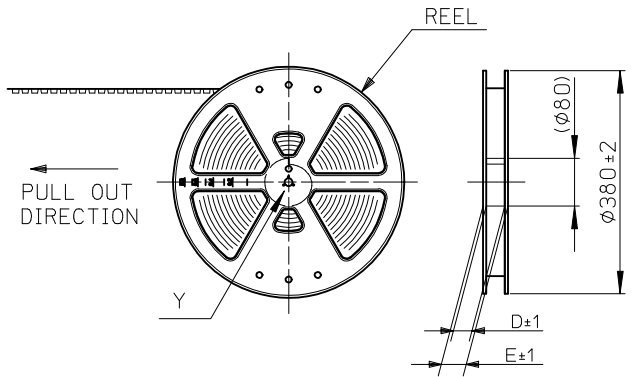
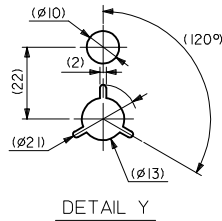

- NOTES**
- 製品番号: 560020-\*\*20, 560020-\*\*30  
 詳細寸法については、製品単体図面を参照ください。  
 PART NO. 560020-\*\*20, 560020-\*\*30  
 SEE SALES DRAWING FOR CONNECTOR
  - 梱包数量: 650個/REEL  
 NUMBER OF CONNECTORS 650 PCS/REEL
  - リードテープ長さ  
 LEAD TAPE LENGTH

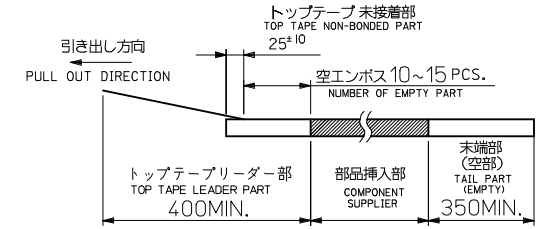
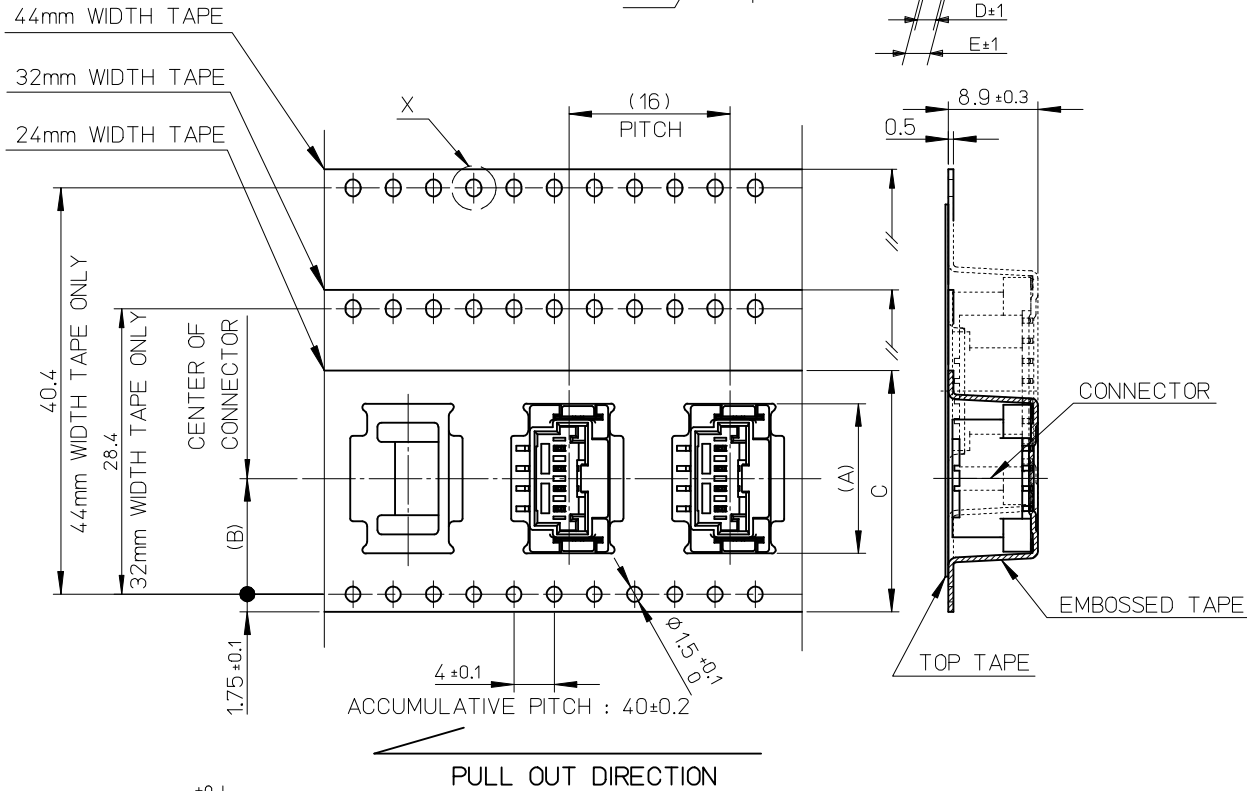

4. 材料  
**MATERIAL**  
 キャリアテープ: ポリスチレン  
 CARRIER TAPE: POLYSTYRENE  
 トップテープ: PET, PE, PEF  
 TOP TAPE  
 リール: ポリスチレン  
 REEL: POLYSTYRENE

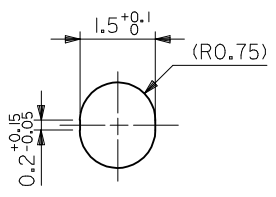

PULL OUT DIRECTION  
 DIRECTION OF CONNECTOR  
 IN EMBOSSSED TAPE

REVISED EC NO: JTR2015-0031 DRWN:YTAMAKI 2014/09/19 CHKD:HKOMATSU 2014/09/19 APPR: MAYAMOTO 2014/10/15	DESCRIPTION A	GENERAL TOLERANCES (UNLESS SPECIFIED)		DIMENSION STYLE MM ONLY	SCALE 2:1	DESIGN UNITS METRIC	THIRD ANGLE PROJECTION	
		10 UNDER	±0.2	DRAWN BY YTAMAKI	DATE 2014/05/23	TITLE 2.0MM PITCH W/B ST. WAFER ASSY EMBOSSSED TAPE PACKAGE		
		10 OVER 30 UNDER	±0.25	CHECKED BY HKOMATSU	DATE 2014/05/23			
		30 OVER	±0.3	APPROVED BY MAYAMOTO	DATE 2014/06/30			
ANGULAR ±1 °		DRAFT WHERE APPLICABLE MUST REMAIN WITHIN DIMENSIONS		MATERIAL NO. SEE CHART	DOCUMENT NO. SD-560020-003	SHEET NO. 1 OF 2		
THIS DRAWING CONTAINS INFORMATION THAT IS PROPRIETARY TO MOLEX INCORPORATED AND SHOULD NOT BE USED WITHOUT WRITTEN PERMISSION								

	10				9					8				7					6					5				4				3				2				1																																										
F	Sn	49.4	45.4	44	20.2	22.9	560020-0820	08	Au	49.4	45.4	44	20.2	22.9	560020-0830	08	20.9	560020-0720	07	37.4	33.4	32	14.2	18.9	560020-0620	06	16.9	560020-0520	05	14.9	560020-0420	04	29.4	25.4	24	11.5	12.9	560020-0320	03	11.2	560020-0220	02																																								
E																																											PLATING	E	D	C	(B)	(A)	エンボス糊包品 製品番号 MATERIAL NO.	CIRCUITS	PLATING	E	D	C	(B)	(A)	エンボス糊包品 製品番号 MATERIAL NO.	CIRCUITS																								
D																																																																																		
C																																																																																		
B																																																																																		
A																																																																																		

REVISED EC NO: JTR2015-0031 DRWN:YTAMAKI 2014/09/19 CHKD:HKOMATSU 2014/09/19 APPR: MAYAMOTO 2014/10/15 A	DESCRIPTION	GENERAL TOLERANCES (UNLESS SPECIFIED)		DIMENSION STYLE	SCALE	DESIGN UNITS	THIRD ANGLE PROJECTION	
				MM ONLY	2:1	METRIC		
		10 UNDER	±0.2	DRAWN BY	DATE	TITLE		
		10 OVER 30 UNDER	±0.25	YTAMAKI	2014/05/23	2.0MM PITCH W/B ST. WAFER ASSY EMBOSSSED TAPE PACKAGE		
30 OVER	±0.3	CHECKED BY	DATE					
		ANGULAR	±1 °	APPROVED BY	DATE	<b>molex</b>		
		DRAFT WHERE APPLICABLE MUST REMAIN WITHIN DIMENSIONS		MAYAMAMOTO	2014/06/30			
				MATERIAL NO.	SEE CHART	DOCUMENT NO.	SHEET NO.	
				SIZE	THIS DRAWING CONTAINS INFORMATION THAT IS PROPRIETARY TO MOLEX INCORPORATED AND SHOULD NOT BE USED WITHOUT WRITTEN PERMISSION			
				A3	SD-560020-003			2 OF 2