

THIS DRAWING IS UNPUBLISHED. RELEASED FOR PUBLICATION
 © COPYRIGHT - By - ALL RIGHTS RESERVED.

LOC		DIST		REVISIONS			
P	LTR	DESCRIPTION		DATE	DWN	APVD	
	A	INITIAL RELEASE		2 JUL 12	CAS	MKS	

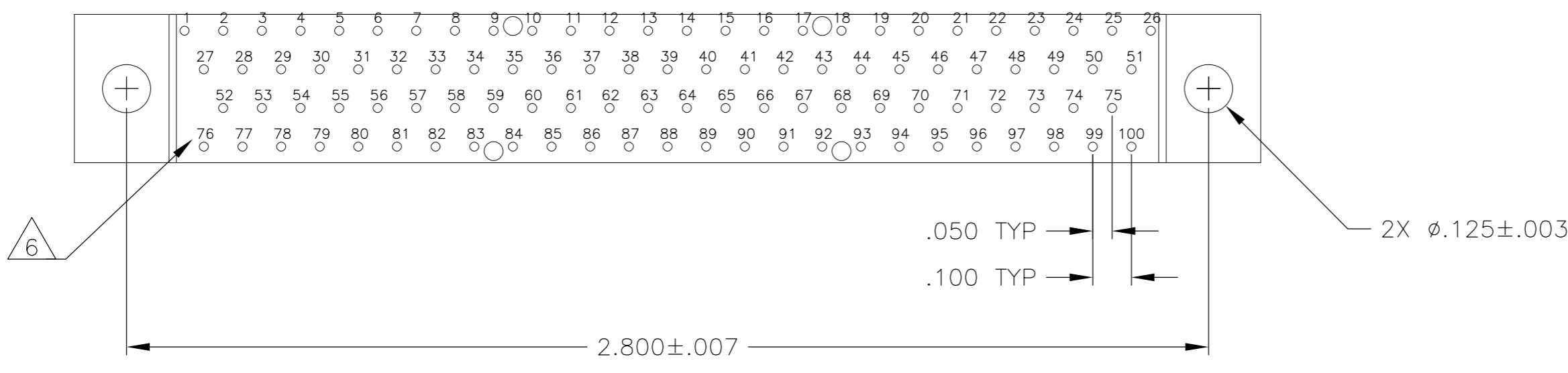
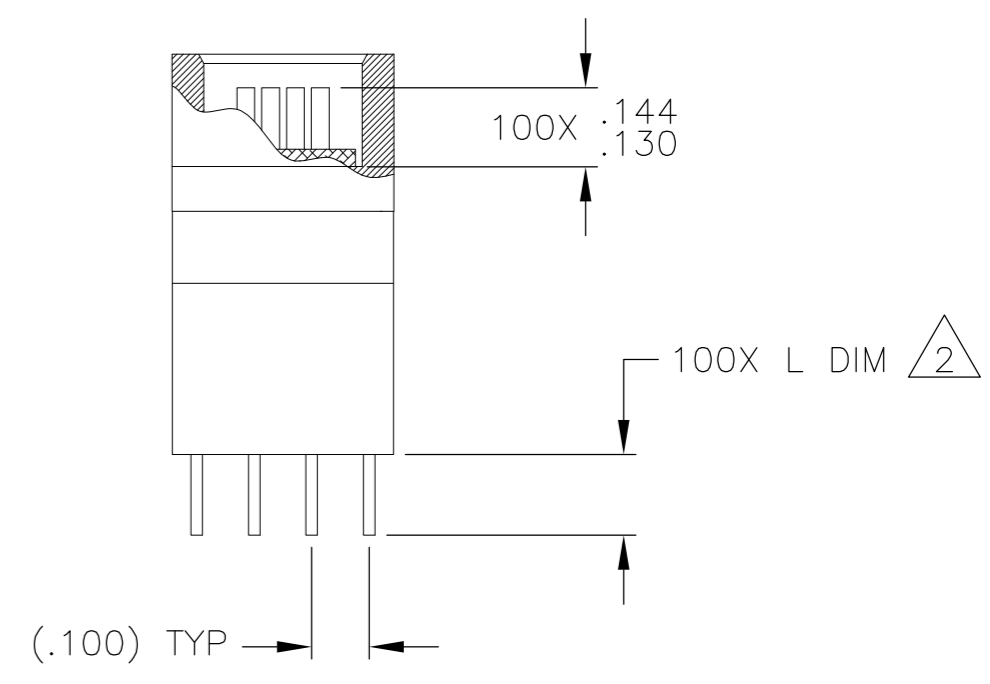
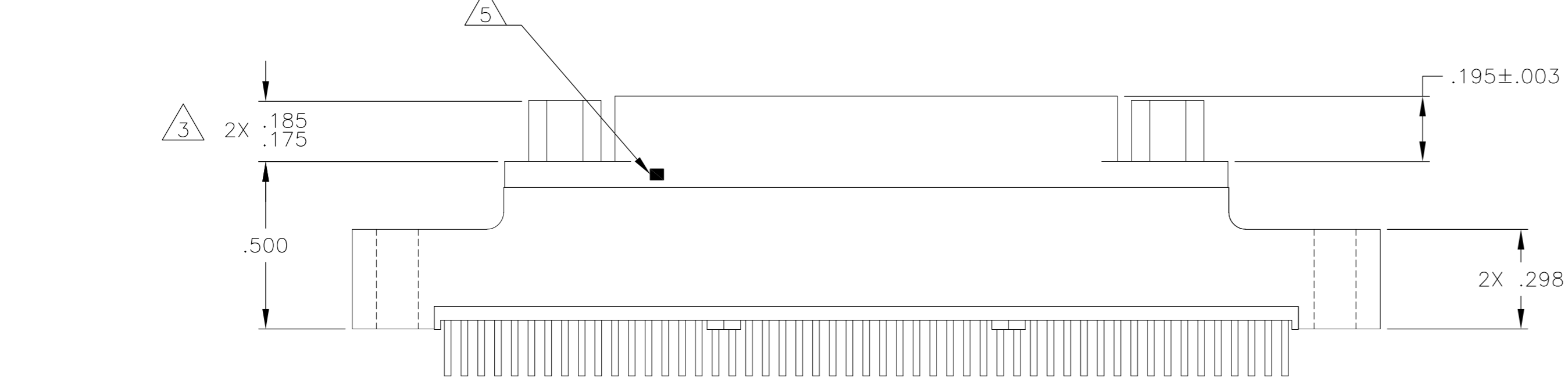
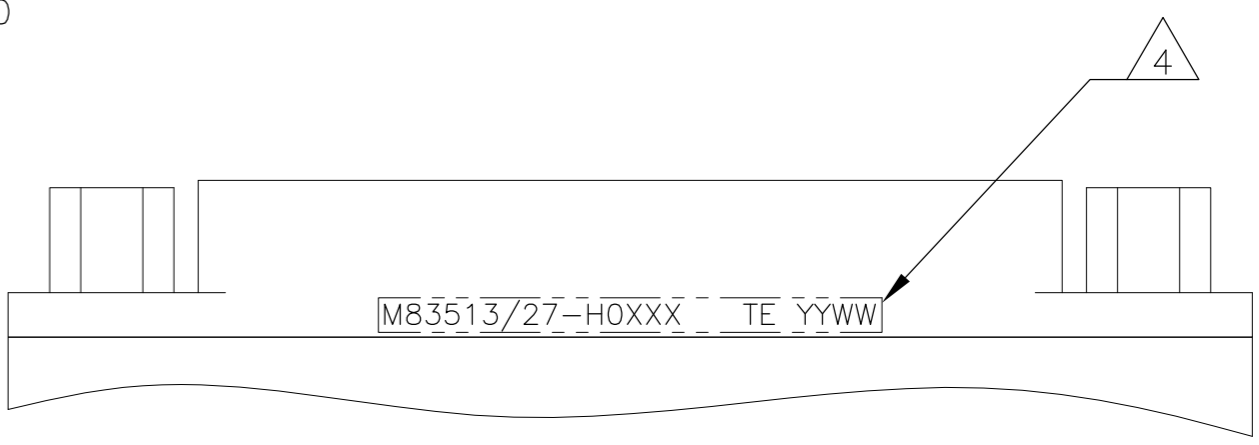
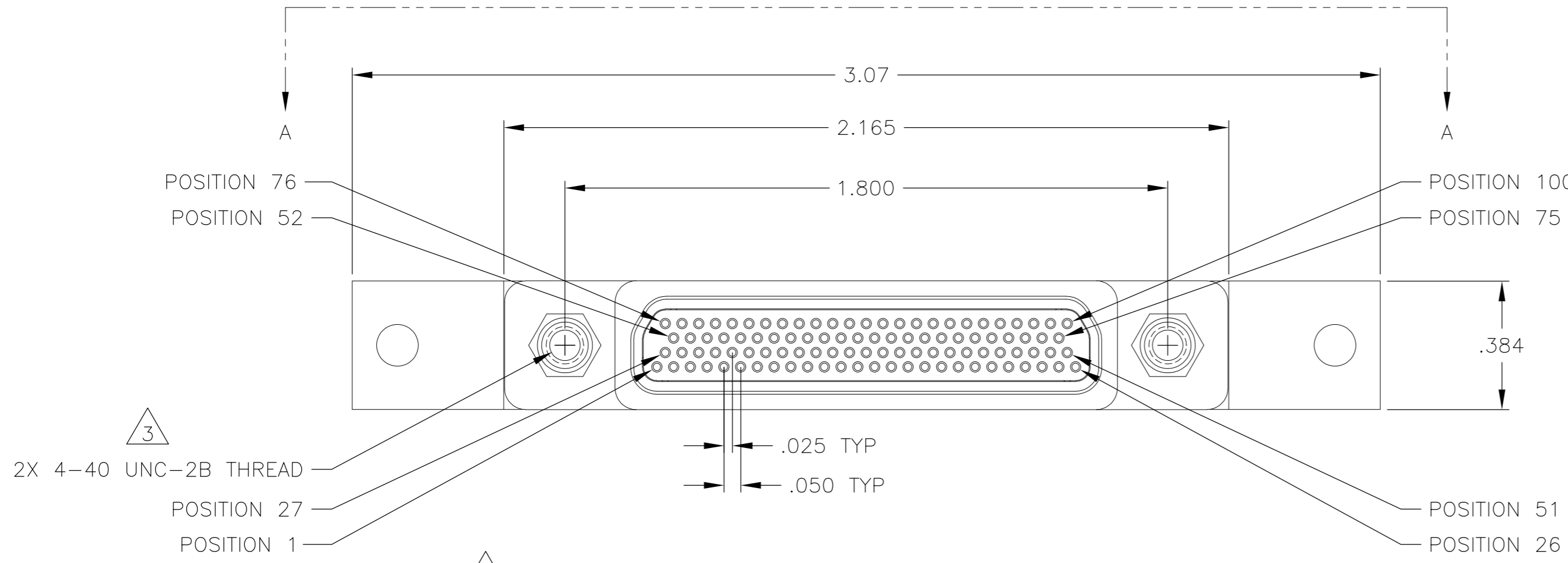

JACKPOSTS OMITTED FOR CLARITY

SEE SHEET 2 FOR NOTES

THIS DRAWING IS A CONTROLLED DOCUMENT.		DWN C SCHOLL 2 JUL 12		
DIMENSIONS: INCHES		CHK M STORRY 2 JUL 12		
TOLERANCES UNLESS OTHERWISE SPECIFIED:		APVD	NAME	
0 PLC ± -		PRODUCT SPEC	RECEPTACLE ASSEMBLY, MCKS, ST1 STRAIGHT	
1 PLC ± -		APPLICATION SPEC	TERMINATION, PCB MOUNT, 4 ROW,	
2 PLC ± .010			SIZE 100, PER MIL-DTL-83513/27	
3 PLC ± .005			SIZE	CAGE CODE
4 PLC ± -			A2	98278
ANGLES ± 1°		WEIGHT	DRAWING NO	RESTRICTED TO
MATERIAL: SEE NOTES		CUSTOMER DRAWING	C=1532281	-
FINISH: SEE NOTES		SCALE	3:1	SHEET
			1 OF 2	REV
				A

THIS DRAWING IS UNPUBLISHED. RELEASED FOR PUBLICATION
 © COPYRIGHT - By - ALL RIGHTS RESERVED.

LOC		DIST		REVISIONS			
P	LTR	DESCRIPTION		DATE	DWN	APVD	
-	-	SEE SHEET 1		-	-	-	

TE PART NUMBER	MIL-DTL-83513 PIN	MCKS DESCRIPTION	SHELL FINISH $\triangle 1$	HARDWARE $\triangle 3$	L DIM $\pm .015$
1532281-1	M83513/27-H01CN	MCKS-C2-B-100SST1	CADMIUM	NONE	.109
1532281-2	M83513/27-H01CP	MCKS-C2-S-100SST1	CADMIUM	JACKPOSTS	.109
1532281-3	M83513/27-H01NN	MCKS-N1-B-100SST1	NICKEL	NONE	.109
1532281-4	M83513/27-H01NP	MCKS-N1-S-100SST1	NICKEL	JACKPOSTS	.109
1532281-5	M83513/27-H02CN	MCKS-C2-B-100SST1A	CADMIUM	NONE	.140
1532281-6	M83513/27-H02CP	MCKS-C2-S-100SST1A	CADMIUM	JACKPOSTS	.140
1532281-7	M83513/27-H02NN	MCKS-N1-B-100SST1A	NICKEL	NONE	.140
1532281-8	M83513/27-H02NP	MCKS-N1-S-100SST1A	NICKEL	JACKPOSTS	.140
1532281-9	M83513/27-H03CN	MCKS-C2-B-100SST1B	CADMIUM	NONE	.172
1-1532281-0	M83513/27-H03CP	MCKS-C2-S-100SST1B	CADMIUM	JACKPOSTS	.172
1-1532281-1	M83513/27-H03NN	MCKS-N1-B-100SST1B	NICKEL	NONE	.172
1-1532281-2	M83513/27-H03NP	MCKS-N1-S-100SST1B	NICKEL	JACKPOSTS	.172

- $\triangle 1$ SHELL MATERIAL: 6061-T6 ALUMINUM
 FINISH OPTIONS:
 ELECTROLESS NICKEL PLATED PER SAE-AMS-C-26074 OR SAE AMS 2404 OR CADMIUM PLATED PER SAE-AMS-QQ-P-416 WITH YELLOW CHROMATE
 INSULATOR: LIQUID CRYSTAL POLYMER (LCP)
 HARDWARE: 300 SERIES STAINLESS STEEL
 TB BOX: POLYPHENYLENE SULFIDE (PPS) AND EPOXY POTTING
- $\triangle 2$ TERMINATION: 24AWG GOLD PLATED COPPER WIRE, Sn63Pb37 SOLDER DIPPED UP TO MOUNTING SURFACE AT A MINIMUM
- $\triangle 3$ JACKPOST HARDWARE SHALL BE PERMANENTLY INSTALLED AS SHOWN WHEN REQUIRED BY THE MIL PIN. JACKPOST DIMENSIONS AND REQUIREMENTS ARE DEFINED IN MIL-DTL-83513/5.
- $\triangle 4$ CONNECTOR SHALL BE MARKED IN ACCORDANCE WITH METHOD I OF MIL-STD-1285. MARKING SHALL CONTAIN THE MILITARY PIN, CAGE CODE (OR TE), AND DATE CODE. EXAMPLE: M83513/27-HOXXX TE YYWW (WHERE XXX IS PART OF THE PIN SHOWN IN THE "MIL-DTL-83513 PIN" COLUMN OF THE PART NUMBER TABLE, AND YYWW IS THE DATE CODE). THE MARKING MUST BE PRINTED ON THE FLANGE. TEXT HEIGHT SHALL BE .035 INCH MINIMUM.
- $\triangle 5$ POSITION 1 SHALL BE INDICATED BY AN IDENTIFIABLE MARK, LOCATED APPROXIMATELY AS SHOWN ON THE POSITION 1 SIDE OF THE CONNECTOR FLANGE. THIS MARK SHALL BE INCLUDED AS PART OF THE PART MARKING INFORMATION.
- $\triangle 6$ TERMINAL IDENTIFICATION NUMBERS AS SHOWN DO NOT ACTUALLY APPEAR ON THE PART (FOR IDENTIFICATION ONLY)
- 7 ALL REQUIREMENTS CONFORM TO MIL-DTL-83513/27. SEE MIL-SPEC FOR DETAILED INTERFACE DIMENSIONS AND SUGGESTED PCB LAYOUTS

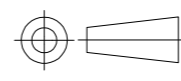
THIS DRAWING IS A CONTROLLED DOCUMENT.		DWN C SCHOLL	2 JUL 12	 TE Connectivity	
DIMENSIONS: INCHES		CHK -	-		
TOLERANCES UNLESS OTHERWISE SPECIFIED:		APVD M STORRY	2 JUL 12	NAME RECEPTACLE ASSEMBLY, MCKS, ST1 STRAIGHT TERMINATION, PCB MOUNT, 4 ROW, SIZE 100, PER MIL-DTL-83513/27	
		PRODUCT SPEC -	-	SIZE A2	
MATERIAL SEE NOTES		APPLICATION SPEC -	-	CAGE CODE 98278	DRAWING NO 1532281
FINISH SEE NOTES		WEIGHT -	-	RESTRICTED TO -	SCALE 3:1
		CUSTOMER DRAWING		SHEET 2 of 2	REV A