

Sin nuestra expresa autorización, queda terminantemente prohibida la reproducción total o parcial de este documento, así como su uso indebido y/o su exhibición o comunicación a terceros. De los infractores se exigirá el correspondiente resarcimiento de daños y perjuicios. Se reserva todos los derechos para el caso de la con cesión de patente de invención o el registro de Modelo industrial

Weitergabe sowie Vervielfältigung dieser Unterlage, Verwertung und Mitteilung ihres Inhaltes ist nicht gestattet, soweit nicht ausdrücklich zugestanden. Zuwiderhandlungen verpflichten zu Schadenersatz. Alle Rechte vorbehalten, insbesondere für den Fall der Patenterteilung oder GMA-Eintragung.

The reproduction, transmission or use of this document or its contents is not permitted without express written authority. Offenders will be liable for damages. All rights, including rights created by patent grant or registration of a utility model or design, are reserved.

# SRF 8A014P (V23134-A0053-X647)

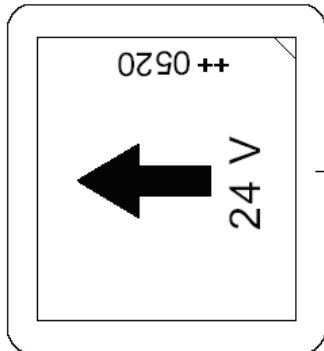
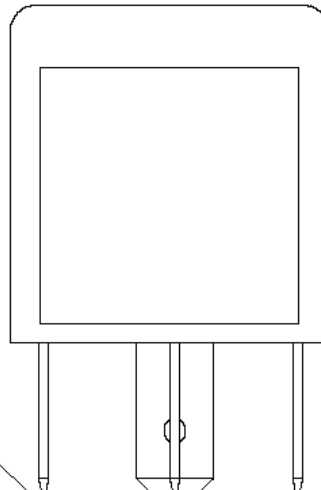
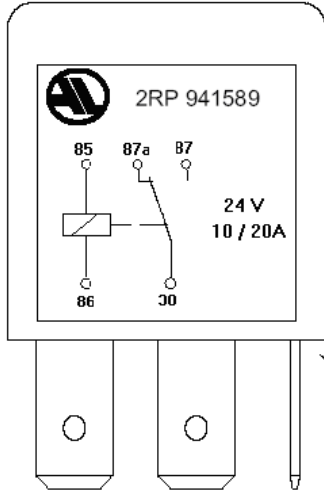
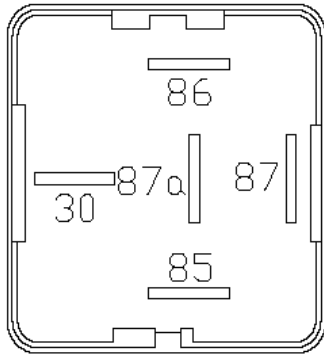

Injection moulded  
0.1 mm raised

TAMPO PRINT  
White Colour

|      |                 |           |      |  |                   |
|------|-----------------|-----------|------|--|-------------------|
| C1   | ---             | 10MAR2016 | LSan | Date   | 09-01-13          |
| C    | ---             | 22MAY2015 | LSan | Eng.   | Sandoval 09-01-12 |
| B    | ---             | 25FEB2014 | LSan | Check  |                   |
| A    | ---             | 06DEC2013 | LSan | Appr.  |                   |
| 62   | Initial Release | 09-06-10  | LSan | <b>PE EVORA</b><br> |                   |
| 61   |                 | 09-05-27  | LSan |  |                   |
| 60   |                 | 09-05-15  | LSan |  |                   |
| 58   |                 | 09-03-25  | LSan |  |                   |
| Rev. | Change Info     | Date      | Name |  |                   |

## Marking Specification for Brazilian Market

Z23134-A0600

Blatt  
1/47

This controlled document is subject to change

Sin nuestra expresa autorización, queda terminantemente prohibida la reproducción total o parcial de este documento, así como su uso indebido y/o su exhibición o comunicación a terceros. De los infractores se exigirá el correspondiente resarcimiento de daños y perjuicios. Se reserva todos los derechos para el caso de la con cesión de patente de invención o el registro de Modelo industrial

Weitergabe sowie Vervielfältigung dieser Unterlage, Verbreitung und Mitteilung ihres Inhaltes nicht gestattet, soweit nicht ausdrücklich zugestanden. Zuwiderhandlungen verpflichten zu Schadenersatz. Alle Rechte vorbehalten, insbesondere für den Fall der Patenterteilung oder GMA-Eintragung.

The reproduction, transmission or use of this document or its contents is not permitted without express written authority. Offenders will be liable for damages. All rights, including rights created by patent grant or registration of a utility model or design, are reserved.

# SRF 8M074 - X645

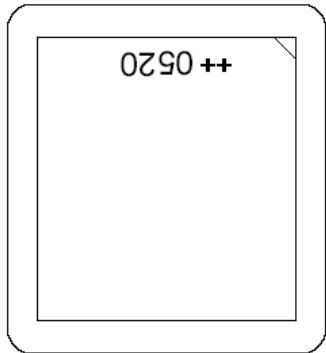
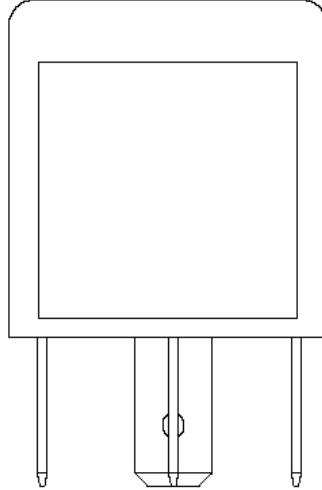
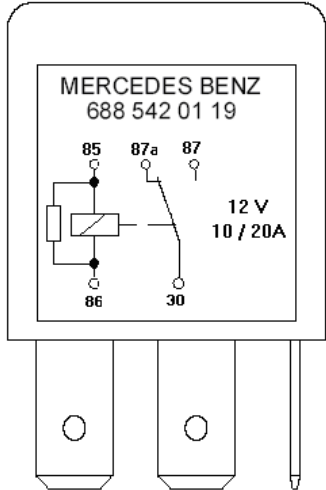
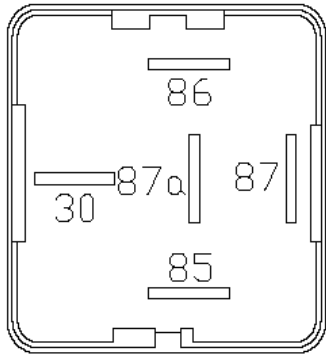

TAMPO PRINT  
White Colour

Injection moulded  
0.1 mm raised

|      |                 |           |      |                 |                   |
|------|-----------------|-----------|------|-----------------|-------------------|
| C1   | ---             | 10MAR2016 | LSan | Date            | 09-01-13          |
| C    | ---             | 22MAY2015 | LSan | Eng.            | Sandoval 09-01-12 |
| B    | ---             | 25FEB2014 | LSan | Check           |                   |
| A    | ---             | 06DEC2013 | LSan | Appr.           |                   |
| 62   | Initial Release | 09-06-10  | LSan | <b>PE EVORA</b> |                   |
| 61   |                 | 09-05-27  | LSan |                 |                   |
| 60   |                 | 09-05-15  | LSan |                 |                   |
| 58   |                 | 09-03-25  | LSan |                 |                   |
| Rev. | Change Info     | Date      | Name |                 |                   |

## Marking Specification for Brazilian Market

Z23134-A0600

Blatt  
2/47

This controlled document is subject to change

Sin nuestra expresa autorización, queda terminantemente prohibida la reproducción total o parcial de este documento, así como su uso indebido y/o su exhibición o comunicación a terceros. De los infractores se exigirá el correspondiente resarcimiento de daños y perjuicios. Se reserva todos los derechos para el caso de la concesión de patente de invención o el registro de Modelo industrial.

Weitergabe sowie Vervielfältigung dieser Unterlage, Verwertung und Mitteilung ihres Inhaltes ist nicht gestattet, soweit nicht ausdrücklich zugestanden. Zuwiderhandlungen verpflichten zu Schadensersatz. Alle Rechte vorbehalten, insbesondere für den Fall der Patenterteilung oder GMA-Eintragung.

The reproduction, transmission or use of this document or its contents is not permitted without express written authority. Offenders will be liable for damages. All rights, including rights created by patent grant or registration of a utility model or design, are reserved.

# V23134-A0052-X601 (V23134A0052Y042P)

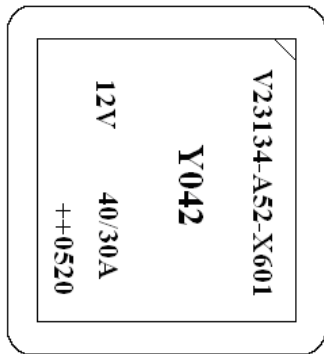
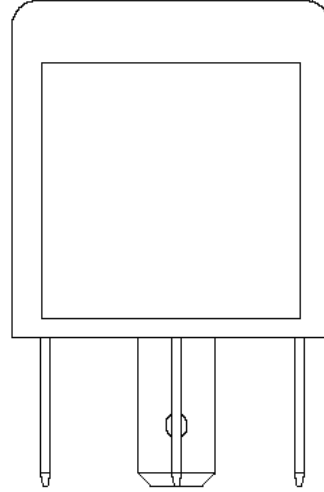
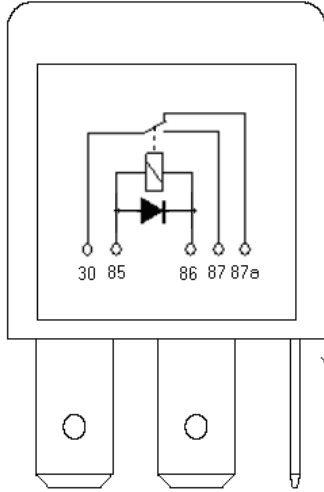
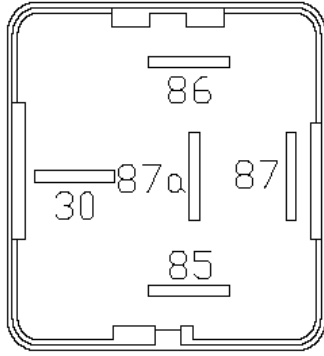

Injection moulded  
0,1 mm raised

TAMPO PRINT  
White Colour

|      |                 |           |      |  |                   |
|------|-----------------|-----------|------|--|-------------------|
| C1   | ---             | 10MAR2016 | LSan | Date   | 09-01-13          |
| C    | ---             | 22MAY2015 | LSan | Eng.   | Sandoval 09-01-12 |
| B    | ---             | 25FEB2014 | LSan | Check  |                   |
| A    | ---             | 06DEC2013 | LSan | Appr.  |                   |
| 62   | Initial Release | 09-06-10  | LSan | <b>PE EVORA</b><br> |                   |
| 61   |                 | 09-05-27  | LSan |  |                   |
| 60   |                 | 09-05-15  | LSan |  |                   |
| 58   |                 | 09-03-25  | LSan |  |                   |
| Rev. | Change Info     | Date      | Name |  |                   |

## Marking Specification for Brazilian Market

Z23134-A0600

Blatt  
3/47

This controlled document is subject to change

Sin nuestra expresa autorización, queda terminantemente prohibida la reproducción total o parcial de este documento, así como su uso indebido y/o su exhibición o comunicación a terceros. De los infractores se exigirá el correspondiente resarcimiento de daños y perjuicios. Se reserva todos los derechos para el caso de la concesión de patente de invención o el registro de Modelo industrial.

Weitergabe sowie Vervielfältigung dieser Unterlage, Verwertung und Mitteilung ihres Inhaltes nicht gestattet, soweit nicht ausdrücklich zugestanden. Zuwiderhandlungen verpflichten zu Schadensersatz. Alle Rechte vorbehalten, insbesondere für den Fall der Patenterteilung oder GMA-Eintragung.

The reproduction, transmission or use of this document or its contents is not permitted without express written authority. Offenders will be liable for damages. All rights, including rights created by patent grant or registration of a utility model or design, are reserved.

# V23134-J1053-X602 (SRF D222EP)

Injection moulded  
0.1 mm raised

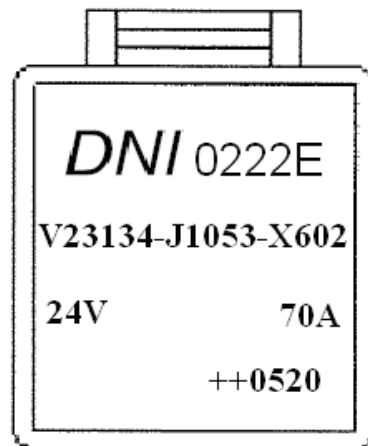
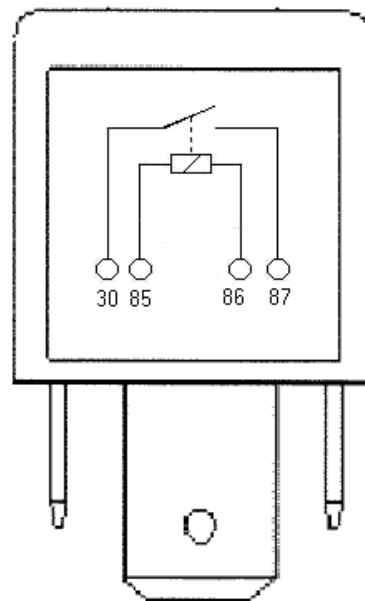
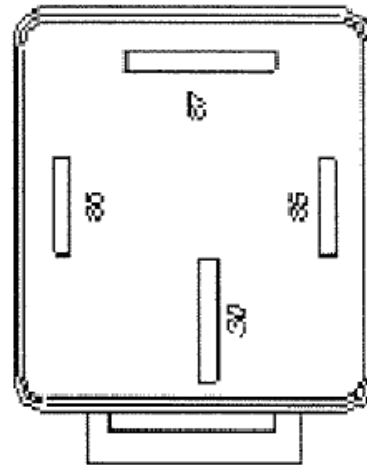
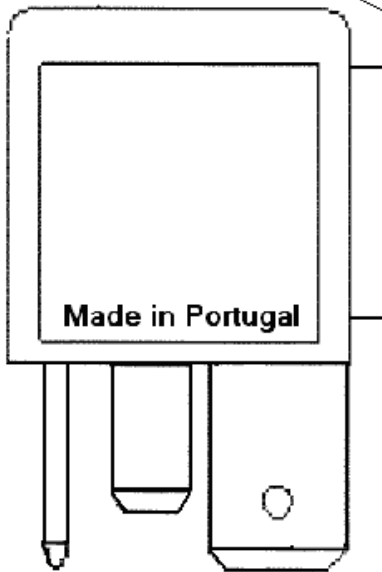

TAMPO PRINT  
White Colour

|      |                 |           |      |                 |                   |
|------|-----------------|-----------|------|-----------------|-------------------|
| C1   | ---             | 10MAR2016 | LSan | Date            | 09-01-13          |
| C    | ---             | 22MAY2015 | LSan | Eng.            | Sandoval 09-01-12 |
| B    | ---             | 25FEB2014 | LSan | Check           |                   |
| A    | ---             | 06DEC2013 | LSan | Appr.           |                   |
| 62   | Initial Release | 09-06-10  | LSan | <b>PE EVORA</b> |                   |
| 61   |                 | 09-05-27  | LSan |                 |                   |
| 60   |                 | 09-05-15  | LSan |                 |                   |
| 58   |                 | 09-03-25  | LSan |                 |                   |
| Rev. | Change Info     | Date      | Name |                 |                   |

## Marking Specification for Brazilian Market

Z23134-A0600

Blatt  
4/47

This controlled document is subject to change

Sin nuestra expresa autorización, queda terminantemente prohibida la reproducción total o parcial de este documento, así como su uso indebido y/o su exhibición o comunicación a terceros. De los infractores se exigirá el correspondiente resarcimiento de daños y perjuicios. Se reserva todos los derechos para el caso de la con cesión de patente de invención o el registro de Modelo industrial

Weitergabe sowie Vervielfältigung dieser Unterlage, Verwertung und Mitteilung ihres Inhaltes nicht gestattet, soweit nicht ausdrücklich zugestanden. Zuwiderhandlungen verpflichten zu Schadensersatz. Alle Rechte vorbehalten, insbesondere für den Fall der Patenterteilung oder GMA-Eintragung.

The reproduction, transmission or use of this document or its contents is not permitted without express written authority. Offenders will be liable for damages. All rights, including rights created by patent grant or registration of a utility model or design, are reserved.

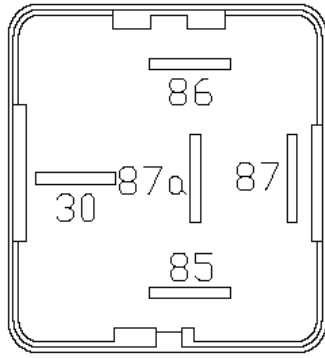

V23134-C0052-X606  
(V23134C0052Y002)

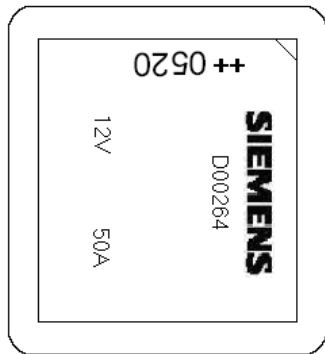
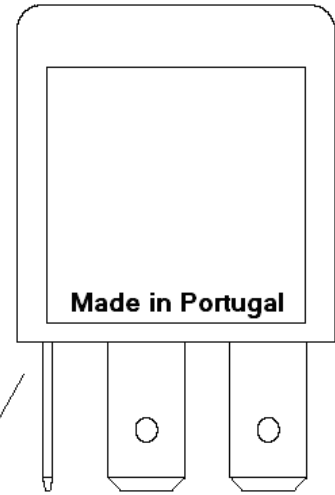
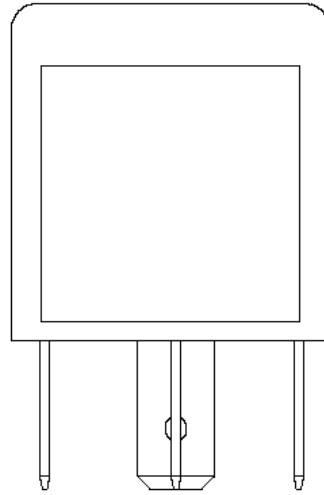
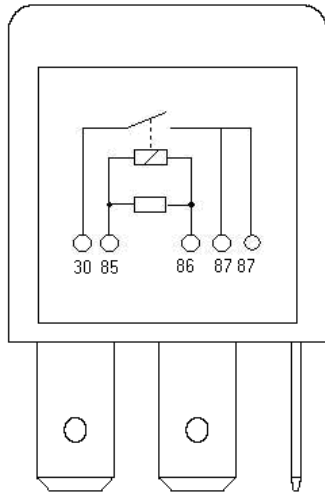

Injection moulded  
0,1 mm raised

TAMPO PRINT  
White Colour

|      |                 |           |      |  |                   |
|------|-----------------|-----------|------|--|-------------------|
| C1   | ---             | 10MAR2016 | LSan | Date   | 09-01-13          |
| C    | ---             | 22MAY2015 | LSan | Eng.   | Sandoval 09-01-12 |
| B    | ---             | 25FEB2014 | LSan | Check  |                   |
| A    | ---             | 06DEC2013 | LSan | Appr.  |                   |
| 62   | Initial Release | 09-06-10  | LSan | <b>PE EVORA</b><br> |                   |
| 61   |                 | 09-05-27  | LSan |  |                   |
| 60   |                 | 09-05-15  | LSan |  |                   |
| 58   |                 | 09-03-25  | LSan |  |                   |
| Rev. | Change Info     | Date      | Name |  |                   |

## Marking Specification for Brazilian Market

Z23134-A0600

Blatt  
5/47

This controlled document is subject to change

Sin nuestra expresa autorización, queda terminantemente prohibida la reproducción total o parcial de este documento, así como su uso indebido y/o su exhibición o comunicación a terceros. De los infractores se exigirá el correspondiente resarcimiento de daños y perjuicios. Se reserva todos los derechos para el caso de la con cesión de patente de invención o el registro de Modelo industrial

Weitergabe sowie Vervielfältigung dieser Unterlage, Verwertung und Mitteilung ihres Inhaltes ist nicht gestattet, soweit nicht ausdrücklich zugestanden. Zuwiderhandlungen verpflichten zu Schadensersatz. Alle Rechte vorbehalten, insbesondere für den Fall der Patenterteilung oder GMA-Eintragung.

The reproduction, transmission or use of this document or its contents is not permitted without express written authority. Offenders will be liable for damages. All rights, including rights created by patent grant or registration of a utility model or design, are reserved.

SRF 8M071  
-X652

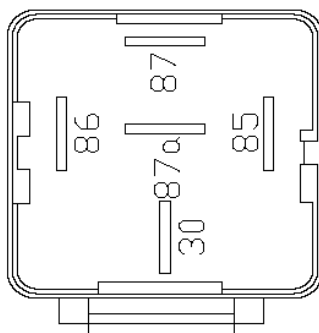

Injection moulded  
0,1 mm raised

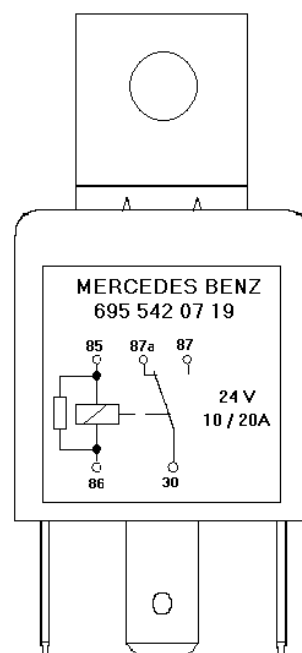
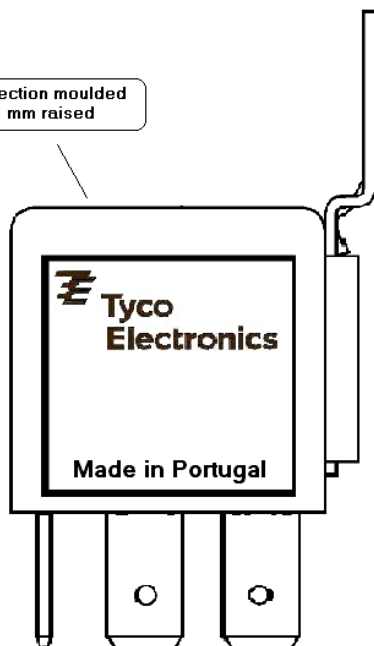

TAMPO PRINT  
White Colour

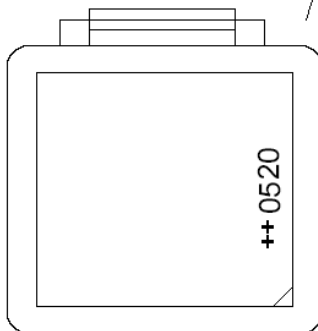

|      |                 |           |      |  |                   |
|------|-----------------|-----------|------|--|-------------------|
| C1   | ---             | 10MAR2016 | LSan | Date   | 09-01-13          |
| C    | ---             | 22MAY2015 | LSan | Eng.   | Sandoval 09-01-12 |
| B    | ---             | 25FEB2014 | LSan | Check  |                   |
| A    | ---             | 06DEC2013 | LSan | Appr.  |                   |
| 62   | Initial Release | 09-06-10  | LSan | <b>PE EVORA</b><br> |                   |
| 61   |                 | 09-05-27  | LSan |  |                   |
| 60   |                 | 09-05-15  | LSan |  |                   |
| 58   |                 | 09-03-25  | LSan |  |                   |
| Rev. | Change Info     | Date      | Name |  |                   |

## Marking Specification for Brazilian Market

Z23134-A0600

Blatt  
6/47

This controlled document is subject to change

Sin nuestra expresa autorización, queda terminantemente prohibida la reproducción total o parcial de este documento, así como su uso indebido y/o su exhibición o comunicación a terceros. De los infractores se exigirá el correspondiente resarcimiento de daños y perjuicios. Se reserva todos los derechos para el caso de la con cesión de patente de invención o el registro de Modelo industrial

Weitergabe sowie Vervielfältigung dieser Unterlage, Verwertung und Mitteilung ihres Inhaltes nicht gestattet, soweit nicht ausdrücklich zugestanden. Zuwiderhandlungen verpflichten zu Schadenersatz. Alle Rechte vorbehalten, insbesondere für den Fall der Patenterteilung oder GMA-Eintragung.

The reproduction, transmission or use of this document or its contents is not permitted without express written authority. Offenders will be liable for damages. All rights, including rights created by patent grant or registration of a utility model or design, are reserved.

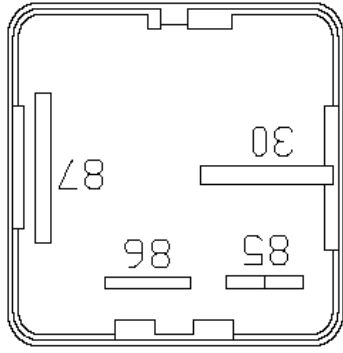

SRF SA53A - X651

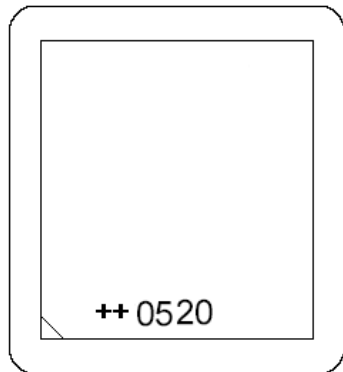
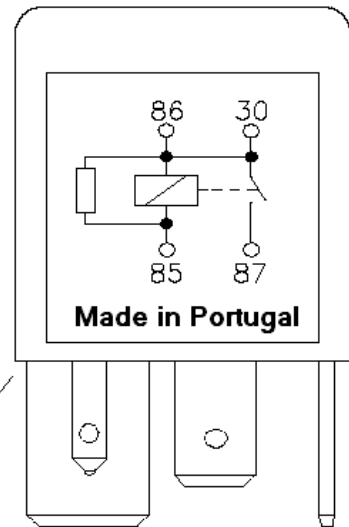
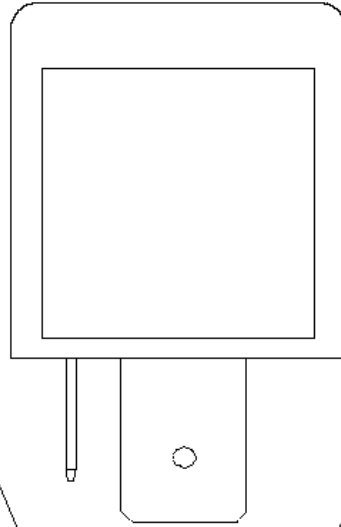
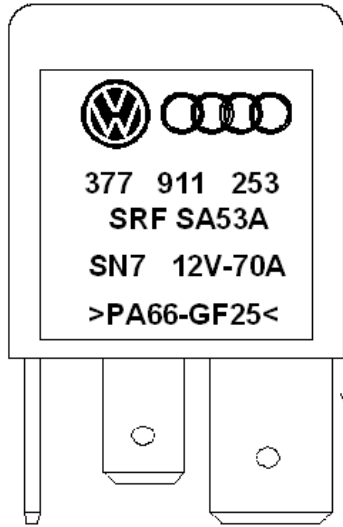

TAMPO PRINT  
Black Colour

Remark: For more information to see marking specification Z23134-A0063

|      |                 |           |      |  |                   |
|------|-----------------|-----------|------|--|-------------------|
| C1   | ---             | 10MAR2016 | LSan | Date   | 09-01-13          |
| C    | ---             | 22MAY2015 | LSan | Eng.   | Sandoval 09-01-12 |
| B    | ---             | 25FEB2014 | LSan | Check  |                   |
| A    | ---             | 06DEC2013 | LSan | Appr.  |                   |
| 62   | Initial Release | 09-06-10  | LSan | <b>PE EVORA</b><br> |                   |
| 61   |                 | 09-05-27  | LSan |  |                   |
| 60   |                 | 09-05-15  | LSan |  |                   |
| 58   |                 | 09-03-25  | LSan |  |                   |
| Rev. | Change Info     | Date      | Name |  |                   |

## Marking Specification for Brazilian Market

Z23134-A0600

Blatt  
7/47

This controlled document is subject to change

Sin nuestra expresa autorización, queda terminantemente prohibida la reproducción total o parcial de este documento, así como su uso indebido y/o su exhibición o comunicación a terceros. De los infractores se exigirá el correspondiente resarcimiento de daños y perjuicios. Se reserva todos los derechos para el caso de la con cesión de patente de invención o el registro de Modelo industrial

Weitergabe sowie Vervielfältigung dieser Unterlage, Verwertung und Mitteilung ihres Inhaltes nicht gestattet, soweit nicht ausdrücklich zugestanden. Zuwiderhandlungen verpflichten zu Schadensersatz. Alle Rechte vorbehalten, insbesondere für den Fall der Patenterteilung oder GMA-Eintragung.

The reproduction, transmission or use of this document or its contents is not permitted without express written authority. Offenders will be liable for damages. All rights, including rights created by patent grant or registration of a utility model or design, are reserved.

SRF 8M072 - X653

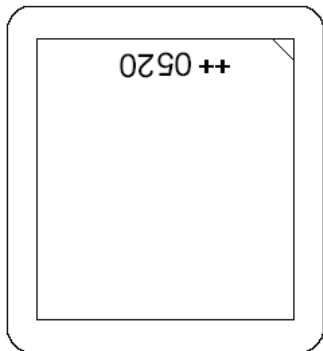
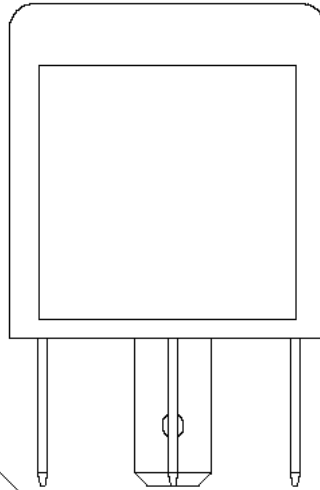
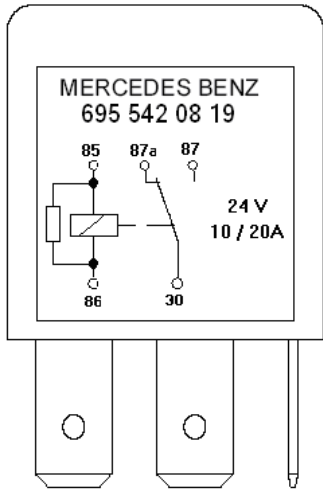
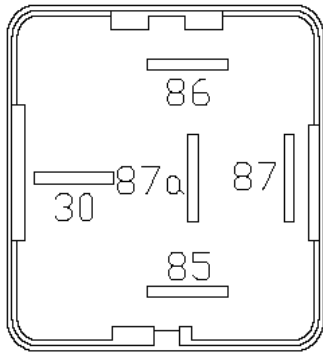

Injection moulded  
0,1 mm raised

TAMPO PRINT  
White Colour

|      |                 |           |      |  |                   |
|------|-----------------|-----------|------|--|-------------------|
| C1   | ---             | 10MAR2016 | LSan | Date   | 09-01-13          |
| C    | ---             | 22MAY2015 | LSan | Eng.   | Sandoval 09-01-12 |
| B    | ---             | 25FEB2014 | LSan | Check  |                   |
| A    | ---             | 06DEC2013 | LSan | Appr.  |                   |
| 62   | Initial Release | 09-06-10  | LSan | <b>PE EVORA</b><br> |                   |
| 61   |                 | 09-05-27  | LSan |  |                   |
| 60   |                 | 09-05-15  | LSan |  |                   |
| 58   |                 | 09-03-25  | LSan |  |                   |
| Rev. | Change Info     | Date      | Name |  |                   |

**Marking Specification for Brazilian Market**

Z23134-A0600

Blatt  
8/47

This controlled document is subject to change

Sin nuestra expresa autorización, queda terminantemente prohibida la reproducción total o parcial de este documento, así como su uso indebido y/o su exhibición o comunicación a terceros. De los infractores se exigirá el correspondiente resarcimiento de daños y perjuicios. Se reserva todos los derechos para el caso de la con cesión de patente de invención o el registro de Modelo industrial

Weitergabe sowie Vervielfältigung dieser Unterlage, Verwertung und Mitteilung ihres Inhaltes nicht gestattet, soweit nicht ausdrücklich zugestanden. Zuwiderhandlungen verpflichten zu Schadensersatz. Alle Rechte vorbehalten, insbesondere für den Fall der Patenterteilung oder GMA-Eintragung.

The reproduction, transmission or use of this document or its contents is not permitted without express written authority. Offenders will be liable for damages. All rights, including rights created by patent grant or registration of a utility model or design, are reserved.

## V23134-J0052-X607 (V23134J0052Y010P)

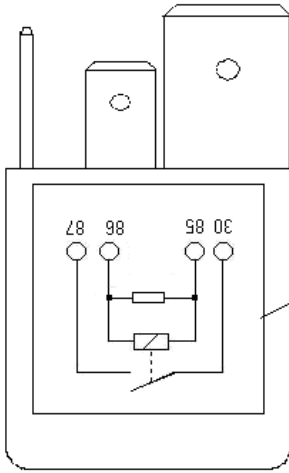

Injection moulded  
0,1 mm raised

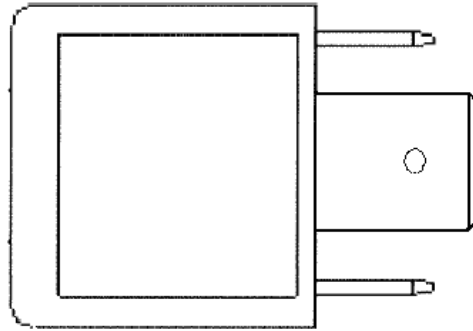
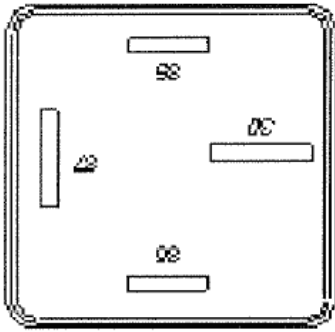

TAMPO PRINT  
Black Colour



Injection moulded  
0,1 mm raised

|      |                 |           |      |                 |                   |
|------|-----------------|-----------|------|-----------------|-------------------|
| C1   | ---             | 10MAR2016 | LSan | Date            | 09-01-13          |
| C    | ---             | 22MAY2015 | LSan | Eng.            | Sandoval 09-01-12 |
| B    | ---             | 25FEB2014 | LSan | Check           |                   |
| A    | ---             | 06DEC2013 | LSan | Appr.           |                   |
| 62   | Initial Release | 09-06-10  | LSan | <b>PE EVORA</b> |                   |
| 61   |                 | 09-05-27  | LSan |                 |                   |
| 60   |                 | 09-05-15  | LSan |                 |                   |
| 58   |                 | 09-03-25  | LSan |                 |                   |
| Rev. | Change Info     | Date      | Name |                 |                   |

### Marking Specification for Brazilian Market

Z23134-A0600

Blatt  
9/47

This controlled document is subject to change

Sin nuestra expresa autorización, queda terminantemente prohibida la reproducción total o parcial de este documento, así como su uso indebido y/o su exhibición o comunicación a terceros. De los infractores se exigirá el correspondiente resarcimiento de daños y perjuicios. Se reserva todos los derechos para el caso de la con cesión de patente de invención o el registro de Modelo industrial

Weitergabe sowie Vervielfältigung dieser Unterlage, Verwertung und Mitteilung ihres Inhaltes nicht gestattet, soweit nicht ausdrücklich zugestanden. Zuwiderhandlungen verpflichten zu Schadenersatz. Alle Rechte vorbehalten, insbesondere für den Fall der Patenterteilung oder GMA-Eintragung.

The reproduction, transmission or use of this document or its contents is not permitted without express written authority. Offenders will be liable for damages. All rights, including rights created by patent grant or registration of a utility model or design, are reserved.

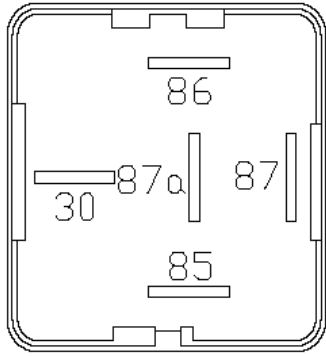

SRF RP059  
X603

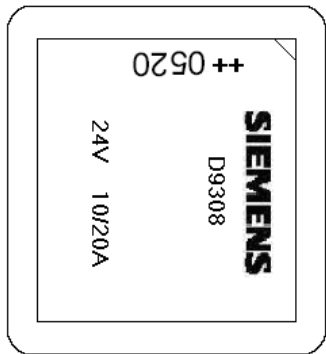
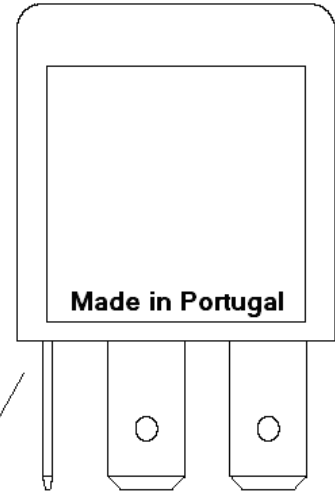
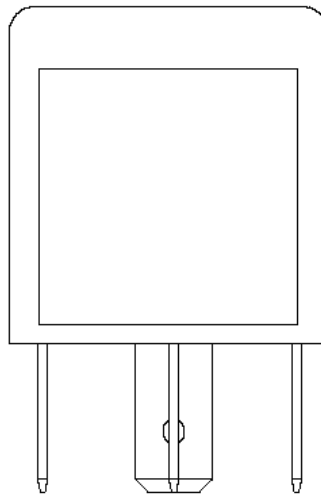
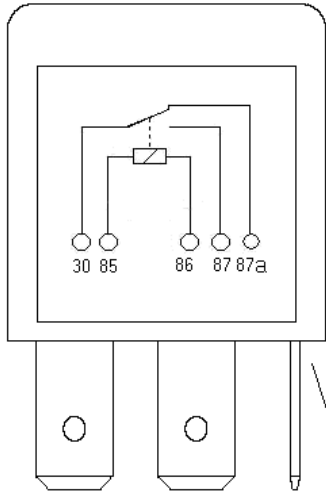

TAMPO PRINT  
White Colour

Injection moulded  
0,1 mm raised

|      |                 |           |      |  |                   |
|------|-----------------|-----------|------|--|-------------------|
| C1   | ---             | 10MAR2016 | LSan | Date   | 09-01-13          |
| C    | ---             | 22MAY2015 | LSan | Eng.   | Sandoval 09-01-12 |
| B    | ---             | 25FEB2014 | LSan | Check  |                   |
| A    | ---             | 06DEC2013 | LSan | Appr.  |                   |
| 62   | Initial Release | 09-06-10  | LSan | <b>PE EVORA</b><br> |                   |
| 61   |                 | 09-05-27  | LSan |  |                   |
| 60   |                 | 09-05-15  | LSan |  |                   |
| 58   |                 | 09-03-25  | LSan |  |                   |
| Rev. | Change Info     | Date      | Name |  |                   |

## Marking Specification for Brazilian Market

Z23134-A0600

Blatt  
10/47

This controlled document is subject to change

Sin nuestra expresa autorización, queda terminantemente prohibida la reproducción total o parcial de este documento, así como su uso indebido y/o su exhibición o comunicación a terceros. De los infractores se exigirá el correspondiente resarcimiento de daños y perjuicios. Se reserva todos los derechos para el caso de la con cesión de patente de invención o el registro de Modelo industrial

Weitergabe sowie Vervielfältigung dieser Unterlage, Verwertung und Mitteilung ihres Inhaltes nicht gestattet, soweit nicht ausdrücklich zugestanden. Zuwiderhandlungen verpflichten zu Schadensersatz. Alle Rechte vorbehalten, insbesondere für den Fall der Patenterteilung oder GMA-Eintragung.

The reproduction, transmission or use of this document or its contents is not permitted without express written authority. Offenders will be liable for damages. All rights, including rights created by patent grant or registration of a utility model or design, are reserved.

SRF 8M075 - X646

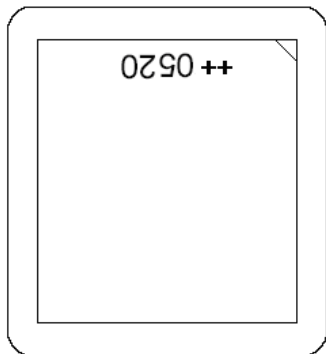
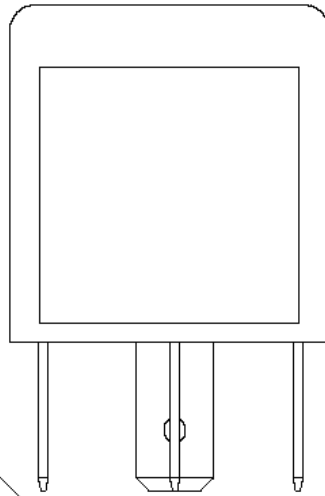
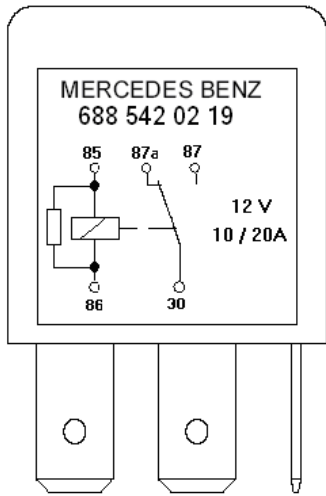
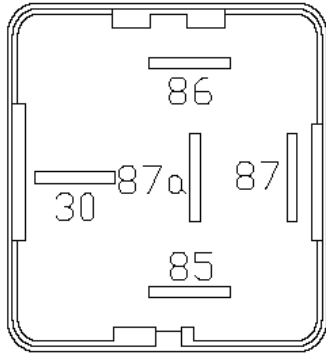

Injection moulded  
0.1 mm raised

TAMPO PRINT  
Black Colour

|      |                 |           |      |  |                   |
|------|-----------------|-----------|------|--|-------------------|
| C1   | ---             | 10MAR2016 | LSan | Date   | 09-01-13          |
| C    | ---             | 22MAY2015 | LSan | Eng.   | Sandoval 09-01-12 |
| B    | ---             | 25FEB2014 | LSan | Check  |                   |
| A    | ---             | 06DEC2013 | LSan | Appr.  |                   |
| 62   | Initial Release | 09-06-10  | LSan | <b>PE EVORA</b><br> |                   |
| 61   |                 | 09-05-27  | LSan |  |                   |
| 60   |                 | 09-05-15  | LSan |  |                   |
| 58   |                 | 09-03-25  | LSan |  |                   |
| Rev. | Change Info     | Date      | Name |  |                   |

**Marking Specification for Brazilian Market**

Z23134-A0600

Blatt  
11/47

This controlled document is subject to change

Sin nuestra expresa autorización, queda terminantemente prohibida la reproducción total o parcial de este documento, así como su uso indebido y/o su exhibición o comunicación a terceros. De los infractores se exigirá el correspondiente resarcimiento de daños y perjuicios. Se reserva todos los derechos para el caso de la con cesión de patente de invención o el registro de Modelo industrial

Weitergabe sowie Vervielfältigung dieser Unterlage, Verwertung und Mitteilung ihres Inhaltes nicht gestattet, soweit nicht ausdrücklich zugestanden. Zuwiderhandlungen verpflichten zu Schadenersatz. Alle Rechte vorbehalten, insbesondere für den Fall der Patenterteilung oder GMA-Eintragung.

The reproduction, transmission or use of this document or its contents is not permitted without express written authority. Offenders will be liable for damages. All rights, including rights created by patent grant or registration of a utility model or design, are reserved.

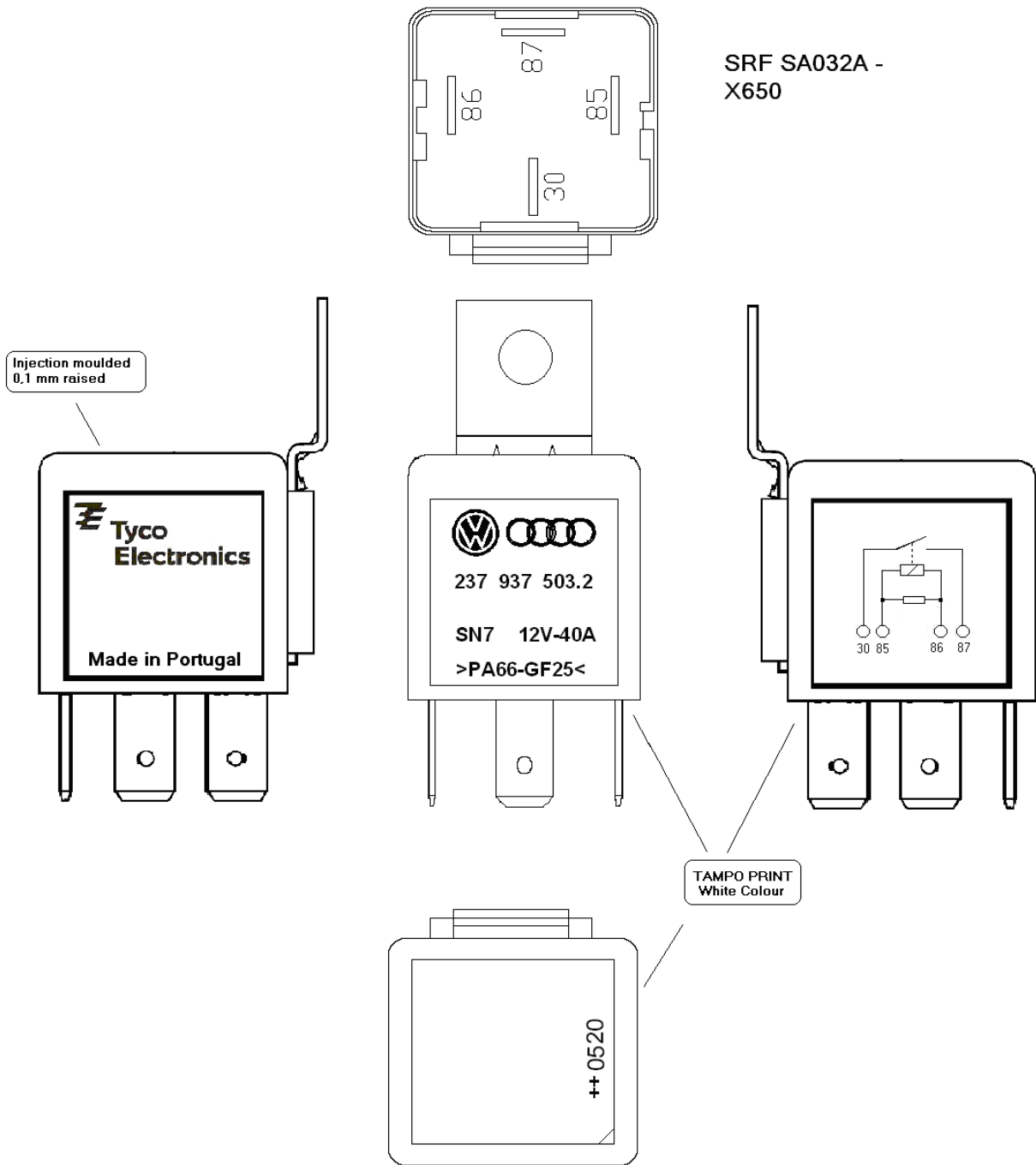

SRF SA032A - X650

Remark: For more information to see marking specification Z23134-A0063

|      |                 |           |      |  |                   |
|------|-----------------|-----------|------|--|-------------------|
| C1   | ---             | 10MAR2016 | LSan | Date   | 09-01-13          |
| C    | ---             | 22MAY2015 | LSan | Eng.   | Sandoval 09-01-12 |
| B    | ---             | 25FEB2014 | LSan | Check  |                   |
| A    | ---             | 06DEC2013 | LSan | Appr.  |                   |
| 62   | Initial Release | 09-06-10  | LSan | <b>PE EVORA</b><br> |                   |
| 61   |                 | 09-05-27  | LSan |  |                   |
| 60   |                 | 09-05-15  | LSan |  |                   |
| 58   |                 | 09-03-25  | LSan |  |                   |
| Rev. | Change Info     | Date      | Name |  |                   |

## Marking Specification for Brazilian Market

Z23134-A0600

Blatt  
12/47

This controlled document is subject to change

Sin nuestra expresa autorización, queda terminantemente prohibida la reproducción total o parcial de este documento, así como su uso indebido y/o su exhibición o comunicación a terceros. De los infractores se exigirá el correspondiente resarcimiento de daños y perjuicios. Se reserva todos los derechos para el caso de la concesión de patente de invención o el registro de Modelo industrial.

Weitergabe sowie Vervielfältigung dieser Unterlage, Verwertung und Mitteilung ihres Inhaltes ist nicht gestattet, soweit nicht ausdrücklich zugestanden. Zuwiderhandlungen verpflichten zu Schadensersatz. Alle Rechte vorbehalten, insbesondere für den Fall der Patenterteilung oder GMA-Eintragung.

The reproduction, transmission or use of this document or its contents is not permitted without express written authority. Offenders will be liable for damages. All rights, including rights created by patent grant or registration of a utility model or design, are reserved.

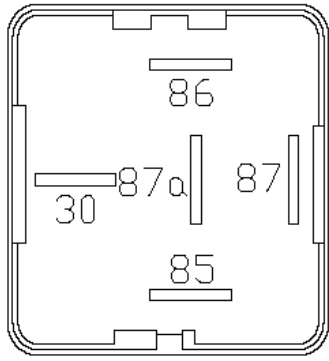

**V23134-A0052-X604  
(V23134A0052Y039P)**

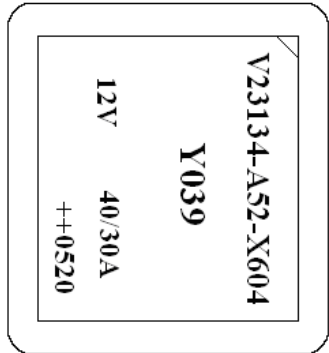
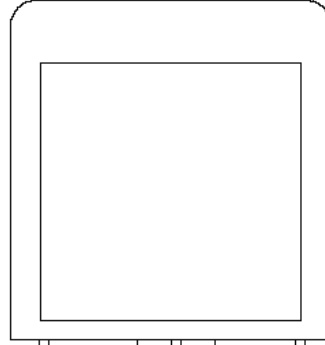
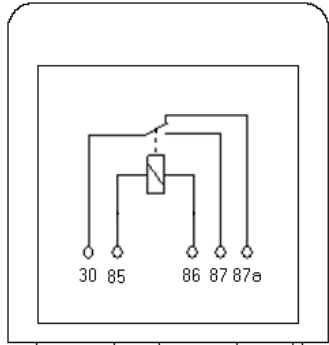

Injection moulded  
0.1 mm raised

TAMPO PRINT  
White Colour

|      |                 |           |      |  |                   |
|------|-----------------|-----------|------|--|-------------------|
| C1   | ---             | 10MAR2016 | LSan | Date   | 09-01-13          |
| C    | ---             | 22MAY2015 | LSan | Eng.   | Sandoval 09-01-12 |
| B    | ---             | 25FEB2014 | LSan | Check  |                   |
| A    | ---             | 06DEC2013 | LSan | Appr.  |                   |
| 62   | Initial Release | 09-06-10  | LSan | <b>PE EVORA</b><br> |                   |
| 61   |                 | 09-05-27  | LSan |  |                   |
| 60   |                 | 09-05-15  | LSan |  |                   |
| 58   |                 | 09-03-25  | LSan |  |                   |
| Rev. | Change Info     | Date      | Name |  |                   |

**Marking Specification for  
Brazilian Market**

**Z23134-A0600**

Blatt  
13/47

This controlled document is subject to change

Sin nuestra expresa autorización, queda terminantemente prohibida la reproducción total o parcial de este documento, así como su uso indebido y/o su exhibición o comunicación a terceros. De los infractores se exigirá el correspondiente resarcimiento de daños y perjuicios. Se reserva todos los derechos para el caso de la con cesión de patente de invención o el registro de Modelo industrial

Weitergabe sowie Vervielfältigung dieser Unterlage, Verwertung und Mitteilung ihres Inhaltes nicht gestattet, soweit nicht ausdrücklich zugestanden. Zuwiderhandlungen verpflichten zu Schadenersatz. Alle Rechte vorbehalten, insbesondere für den Fall der Patenterteilung oder GMA-Eintragung.

The reproduction, transmission or use of this document or its contents is not permitted without express written authority. Offenders will be liable for damages. All rights, including rights created by patent grant or registration of a utility model or design, are reserved.

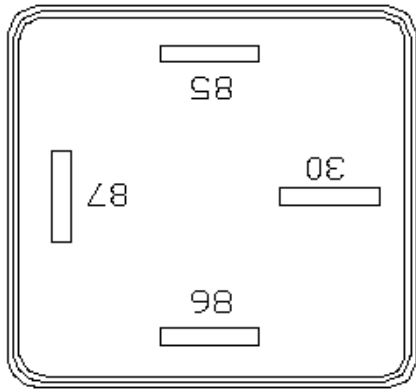

Injection moulded  
0,1 mm raised

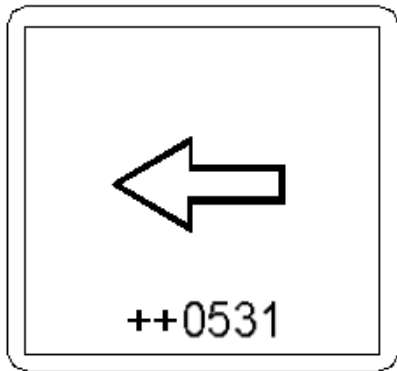
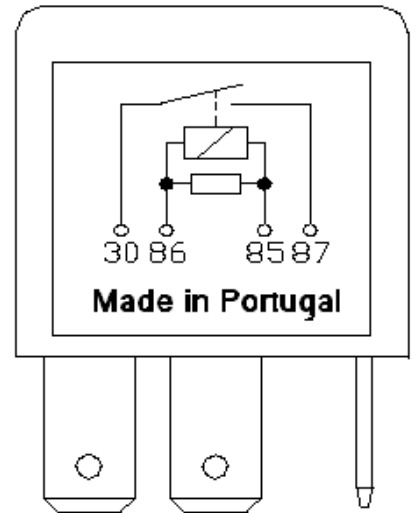
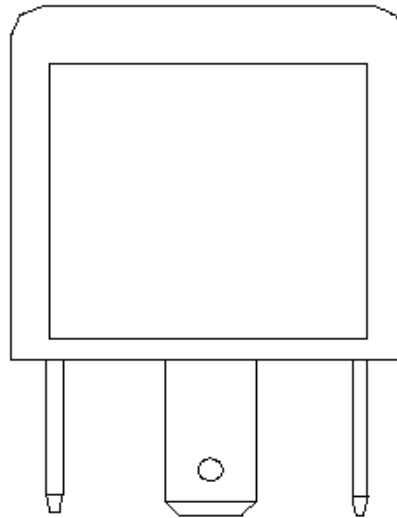
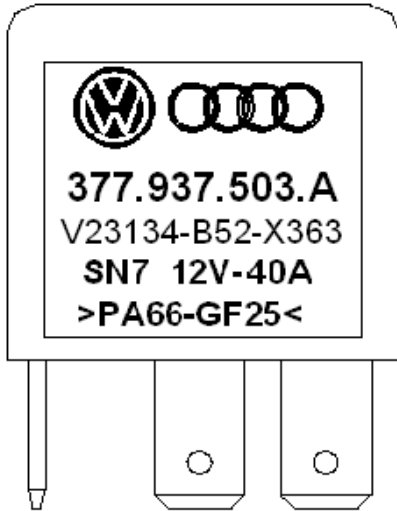

TAMPO PRINT  
White Colour

Remark: For more information to see marking specification Z23134-A0063

|      |                 |           |      |  |                   |
|------|-----------------|-----------|------|--|-------------------|
| C1   | ---             | 10MAR2016 | LSan | Date   | 09-01-13          |
| C    | ---             | 22MAY2015 | LSan | Eng.   | Sandoval 09-01-12 |
| B    | ---             | 25FEB2014 | LSan | Check  |                   |
| A    | ---             | 06DEC2013 | LSan | Appr.  |                   |
| 62   | Initial Release | 09-06-10  | LSan | <b>PE EVORA</b><br> |                   |
| 61   |                 | 09-05-27  | LSan |  |                   |
| 60   |                 | 09-05-15  | LSan |  |                   |
| 58   |                 | 09-03-25  | LSan |  |                   |
| Rev. | Change Info     | Date      | Name |  |                   |

## Marking Specification for Brazilian Market

Z23134-A0600

Blatt  
14/47

This controlled document is subject to change

Sin nuestra expresa autorización, queda terminantemente prohibida la reproducción total o parcial de este documento, así como su uso indebido y/o su exhibición o comunicación a terceros. De los infractores se exigirá el correspondiente resarcimiento de daños y perjuicios. Se reserva todos los derechos para el caso de la con cesión de patente de invención o el registro de Modelo industrial

Weitergabe sowie Vervielfältigung dieser Unterlage, Verwertung und Mitteilung ihres Inhaltes nicht gestattet, soweit nicht ausdrücklich zugestanden. Zuwiderhandlungen verpflichten zu Schadensersatz. Alle Rechte vorbehalten, insbesondere für den Fall der Patenterteilung oder GMA-Eintragung.

The reproduction, transmission or use of this document or its contents is not permitted without express written authority. Offenders will be liable for damages. All rights, including rights created by patent grant or registration of a utility model or design, are reserved.

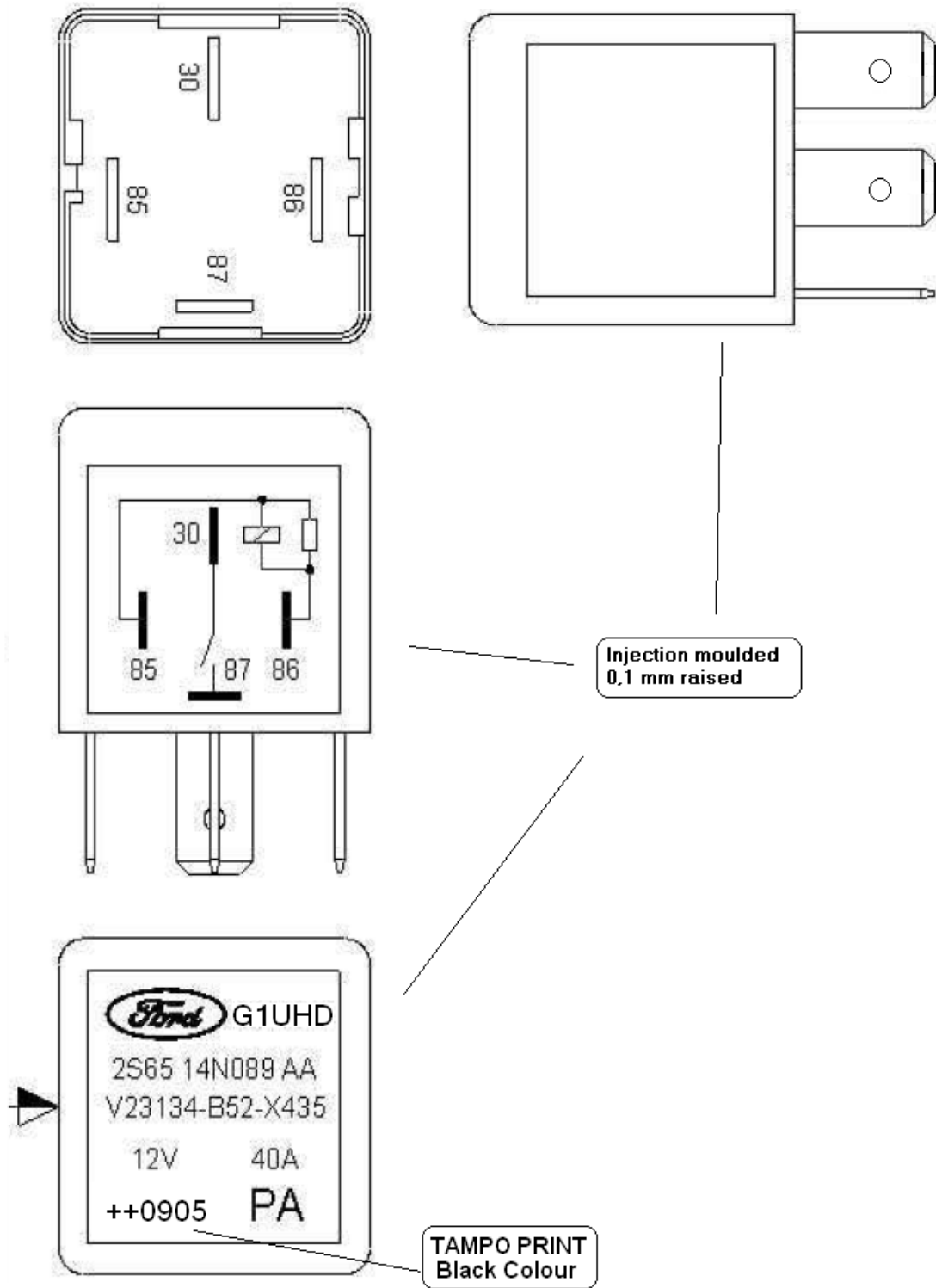

|      |                 |           |      |  |                   |
|------|-----------------|-----------|------|--|-------------------|
| C1   | ---             | 10MAR2016 | LSan | Date   | 09-01-13          |
| C    | ---             | 22MAY2015 | LSan | Eng.   | Sandoval 09-01-12 |
| B    | ---             | 25FEB2014 | LSan | Check  |                   |
| A    | ---             | 06DEC2013 | LSan | Appr.  |                   |
| 62   | Initial Release | 09-06-10  | LSan | <b>PE EVORA</b><br> |                   |
| 61   |                 | 09-05-27  | LSan |  |                   |
| 60   |                 | 09-05-15  | LSan |  |                   |
| 58   |                 | 09-03-25  | LSan |  |                   |
| Rev. | Change Info     | Date      | Name |  |                   |

## Marking Specification for Brazilian Market

Z23134-A0600

Blatt  
15/47

This controlled document is subject to change

Sin nuestra expresa autorización, queda terminantemente prohibida la reproducción total o parcial de este documento, así como su uso indebido y/o su exhibición o comunicación a terceros. De los infractores se exigirá el correspondiente resarcimiento de daños y perjuicios. Se reserva todos los derechos para el caso de la con cesión de patente de invención o el registro de Modelo industrial

Weitergabe sowie Vervielfältigung dieser Unterlage, Verwertung und Mitteilung ihres Inhaltes ist nicht gestattet, soweit nicht ausdrücklich zugestanden. Zuwiderhandlungen verpflichten zu Schadensersatz. Alle Rechte vorbehalten, insbesondere für den Fall der Patenterteilung oder GMA-Eintragung.

The reproduction, transmission or use of this document or its contents is not permitted without express written authority. Offenders will be liable for damages. All rights, including rights created by patent grant or registration of a utility model or design, are reserved.

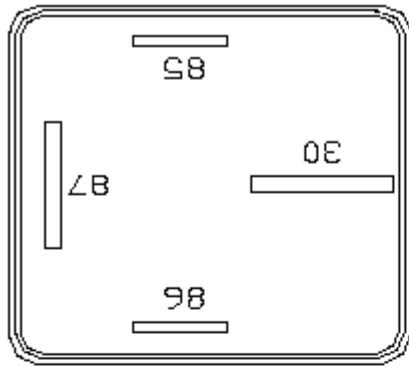

Injection moulded  
0,1 mm raised

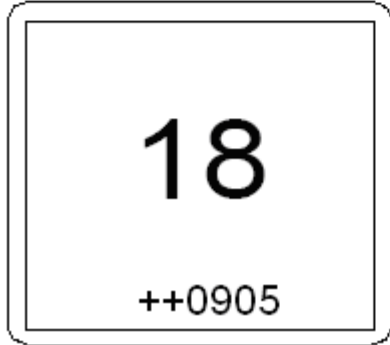
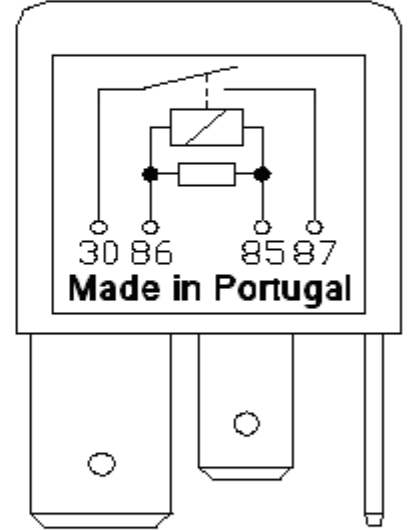
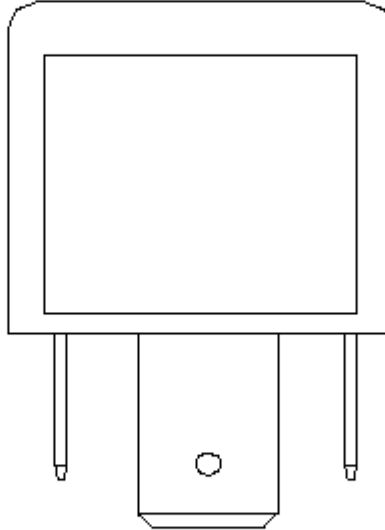
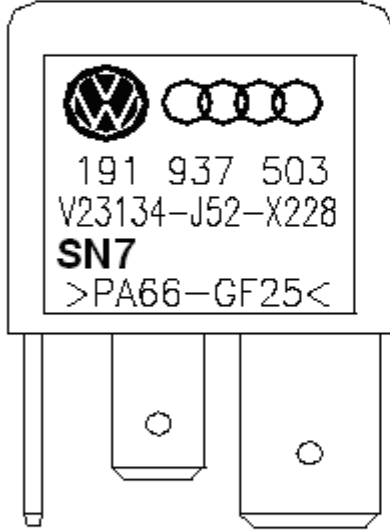

TAMPO PRINT  
Black colour

Remark: For more information to see marking specification Z23134-A0063

|      |                 |           |      |  |                   |
|------|-----------------|-----------|------|--|-------------------|
| C1   | ---             | 10MAR2016 | LSan | Date   | 09-01-13          |
| C    | ---             | 22MAY2015 | LSan | Eng.   | Sandoval 09-01-12 |
| B    | ---             | 25FEB2014 | LSan | Check  |                   |
| A    | ---             | 06DEC2013 | LSan | Appr.  |                   |
| 62   | Initial Release | 09-06-10  | LSan | <b>PE EVORA</b><br> |                   |
| 61   |                 | 09-05-27  | LSan |  |                   |
| 60   |                 | 09-05-15  | LSan |  |                   |
| 58   |                 | 09-03-25  | LSan |  |                   |
| Rev. | Change Info     | Date      | Name |  |                   |

## Marking Specification for Brazilian Market

Z23134-A0600

Blatt  
16/47

This controlled document is subject to change

Sin nuestra expresa autorización, queda terminantemente prohibida la reproducción total o parcial de este documento, así como su uso indebido y/o su exhibición o comunicación a terceros. De los infractores se exigirá el correspondiente resarcimiento de daños y perjuicios. Se reserva todos los derechos para el caso de la con cesión de patente de invención o el registro de Modelo industrial

Weitergabe sowie Vervielfältigung dieser Unterlage, Verwertung und Mitteilung ihres Inhaltes nicht gestattet, soweit nicht ausdrücklich zugestanden. Zuwiderhandlungen verpflichten zu Schadensersatz. Alle Rechte vorbehalten, insbesondere für den Fall der Patenterteilung oder GMA-Eintragung.

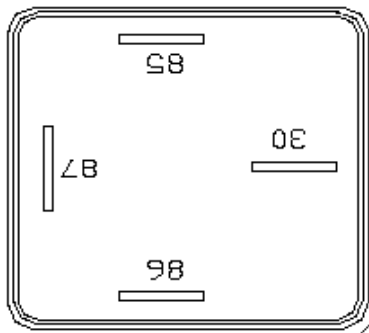

Injection moulded  
0,1 mm raised

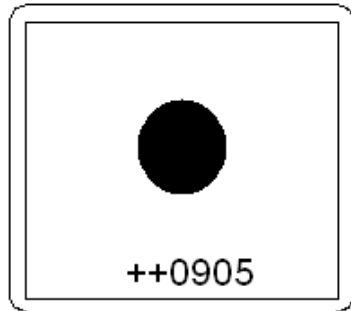
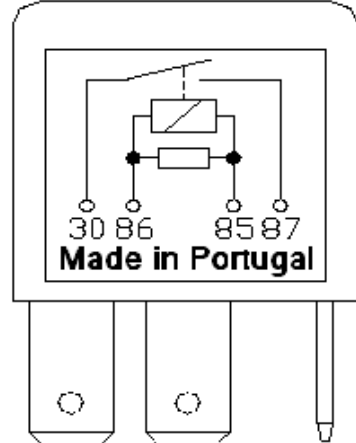
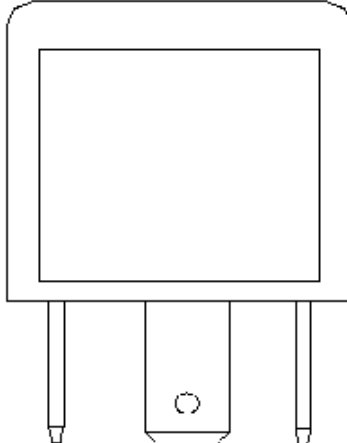
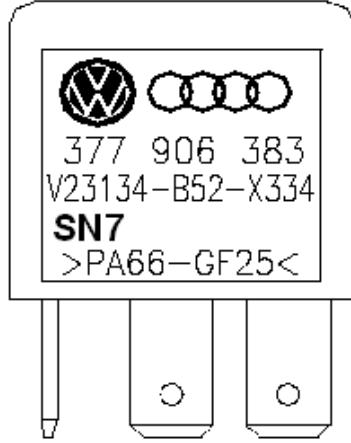

TAMPO PRINT

Marca redonda cor branca.

Remark: For more information to see marking specification Z23134-A0063

The reproduction, transmission or use of this document or its contents is not permitted without express written authority. Offenders will be liable for damages. All rights, including rights created by patent grant or registration of a utility model or design, are reserved.

|      |                 |           |      |  |                   |
|------|-----------------|-----------|------|--|-------------------|
| C1   | ---             | 10MAR2016 | LSan | Date   | 09-01-13          |
| C    | ---             | 22MAY2015 | LSan | Eng.   | Sandoval 09-01-12 |
| B    | ---             | 25FEB2014 | LSan | Check  |                   |
| A    | ---             | 06DEC2013 | LSan | Appr.  |                   |
| 62   | Initial Release | 09-06-10  | LSan | <b>PE EVORA</b><br> |                   |
| 61   |                 | 09-05-27  | LSan |  |                   |
| 60   |                 | 09-05-15  | LSan |  |                   |
| 58   |                 | 09-03-25  | LSan |  |                   |
| Rev. | Change Info     | Date      | Name |  |                   |

## Marking Specification for Brazilian Market

Z23134-A0600

Blatt  
17/47

This controlled document is subject to change

Sin nuestra expresa autorización, queda terminantemente prohibida la reproducción, total o parcial de este documento, así como su uso indebido y/o su exhibición o comunicación a terceros. De los infractores se exigirá el correspondiente resarcimiento de daños y perjuicios. Se reserva todos los derechos para el caso de la con cesión de patente de invención o el registro de Modelo industrial

Weitergabe sowie Vervielfältigung dieser Unterlage, Verwertung und Mitteilung ihres Inhaltes nicht gestattet, soweit nicht ausdrücklich zugestanden. Zuwiderhandlungen verpflichten zu Schadensersatz. Alle Rechte vorbehalten, insbesondere für den Fall der Patenterteilung oder GMA-Eintragung.

The reproduction, transmission or use of this document or its contents is not permitted without express written authority. Offenders will be liable for damages. All rights, including rights created by patent grant or registration of a utility model or design, are reserved.

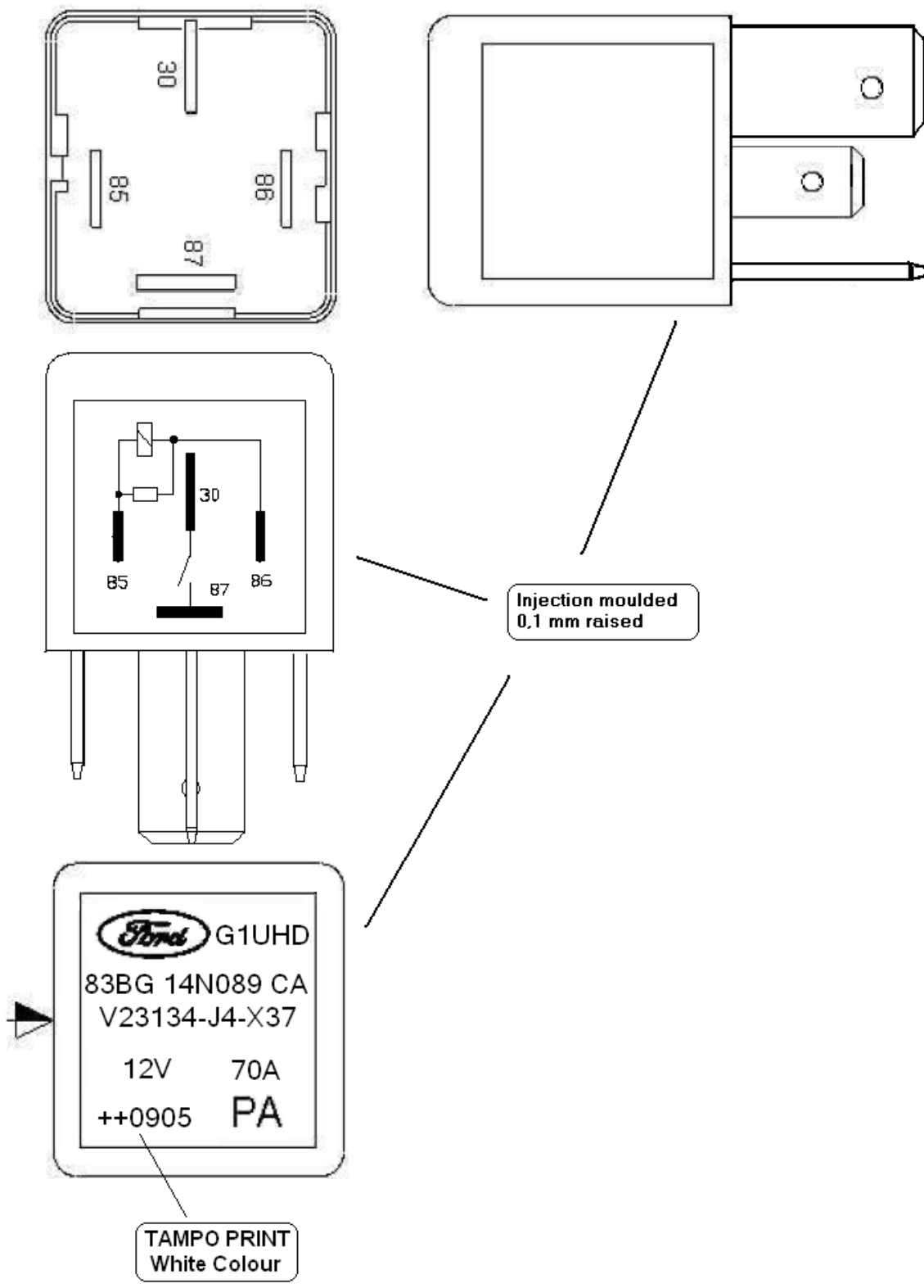

Remark: For more information to see marking specification Z23134-A0014.

|      |                 |           |      |  |                   |
|------|-----------------|-----------|------|--|-------------------|
| C1   | ---             | 10MAR2016 | LSan | Date   | 09-01-13          |
| C    | ---             | 22MAY2015 | LSan | Eng.   | Sandoval 09-01-12 |
| B    | ---             | 25FEB2014 | LSan | Check  |                   |
| A    | ---             | 06DEC2013 | LSan | Appr.  |                   |
| 62   | Initial Release | 09-06-10  | LSan | <b>PE EVORA</b><br> |                   |
| 61   |                 | 09-05-27  | LSan |  |                   |
| 60   |                 | 09-05-15  | LSan |  |                   |
| 58   |                 | 09-03-25  | LSan |  |                   |
| Rev. | Change Info     | Date      | Name |  |                   |

## Marking Specification for Brazilian Market

Z23134-A0600

Blatt  
18/47

This controlled document is subject to change

Sin nuestra expresa autorización, queda terminantemente prohibida la reproducción total o parcial de este documento, así como su uso indebido y/o su exhibición o comunicación a terceros. De los infractores se exigirá el correspondiente resarcimiento de daños y perjuicios. Se reserva todos los derechos para el caso de la con cesión de patente de invención o el registro de Modelo industrial

Weitergabe sowie Vervielfältigung dieser Unterlage, Verwertung und Mitteilung ihres Inhaltes nicht gestattet, soweit nicht ausdrücklich zugestanden. Zuwiderhandlungen verpflichten zu Schadensersatz. Alle Rechte vorbehalten, insbesondere für den Fall der Patenterteilung oder GMA-Eintragung.

The reproduction, transmission or use of this document or its contents is not permitted without express written authority. Offenders will be liable for damages. All rights, including rights created by patent grant or registration of a utility model or design, are reserved.

TE LOGO  
according to TE specification 15989 -  
Lettering Size= Part Number 1-15989-1

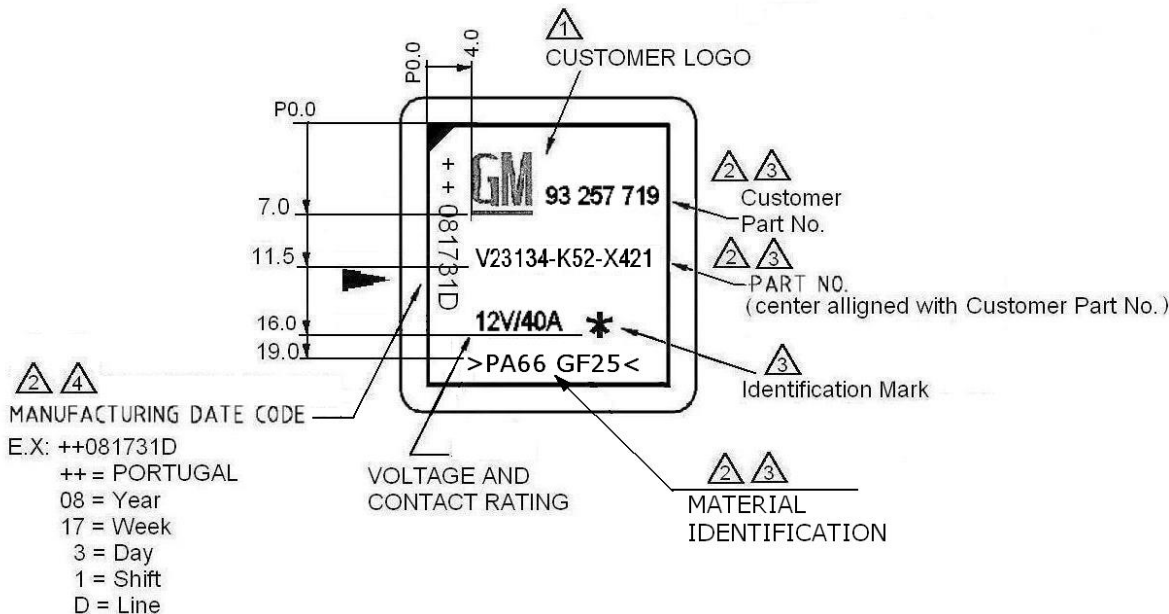
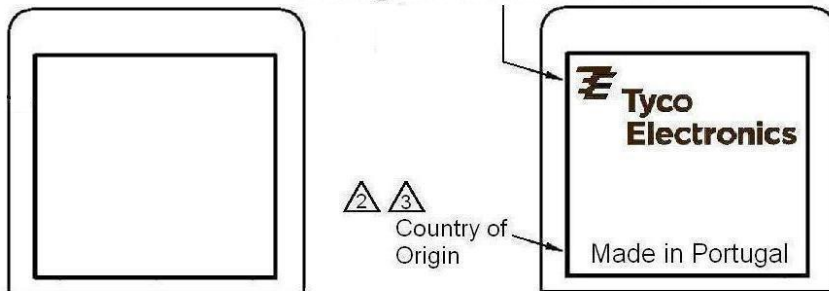

- 1 According to ON 1396.5 - Size 2
- 2 Lettering Size: Arial font, Height 2.0 ± 0,1mm
- 3 Stamped (gasoline proof), Marking colour WHITE for black cover and BLACK for other cover colours. or Injection moulded (0,1 mm raised)
- 4 Stamped (gasoline proof), Marking colour WHITE for black cover and BLACK for other cover colours.

Marking should not touch the edge of marking area

► Latching nose (cover)

**Remark: If ink printed, then lettering size 1,8 +0,1 for PART NO.**

Currently Situation: All Injection molded exception Star and Date code (Black)

|      |                 |           |      |                     |                   |
|------|-----------------|-----------|------|---------------------|-------------------|
| C1   | ---             | 10MAR2016 | LSan | Date                | 09-01-13          |
| C    | ---             | 22MAY2015 | LSan | Eng.                | Sandoval 09-01-12 |
| B    | ---             | 25FEB2014 | LSan | Check               |                   |
| A    | ---             | 06DEC2013 | LSan | Appr.               |                   |
| 62   | Initial Release | 09-06-10  | LSan | <b>PE EVORA</b><br> |                   |
| 61   |                 | 09-05-27  | LSan |                     |                   |
| 60   |                 | 09-05-15  | LSan |                     |                   |
| 58   |                 | 09-03-25  | LSan |                     |                   |
| Rev. | Change Info     | Date      | Name |                     |                   |

## Marking Specification for Brazilian Market

**Z23134-A0600**

Blatt  
19/47

This controlled document is subject to change

Sin nuestra expresa autorización, queda terminantemente prohibida la reproducción total o parcial de este documento, así como su uso indebido y/o su exhibición o comunicación a terceros. De los infractores se exigirá el correspondiente resarcimiento de daños y perjuicios. Se reserva todos los derechos para el caso de la con cesión de patente de invención o el registro de Modelo industrial

Weitergabe sowie Vervielfältigung dieser Unterlage, Verwertung und Mitteilung ihres Inhaltes nicht gestattet, soweit nicht ausdrücklich zugestanden. Zuwiderhandlungen verpflichten zu Schadensersatz. Alle Rechte vorbehalten, insbesondere für den Fall der Patenterteilung oder GMA-Eintragung.

The reproduction, transmission or use of this document or its contents is not permitted without express written authority. Offenders will be liable for damages. All rights, including rights created by patent grant or registration of a utility model or design, are reserved.

 TE LOGO  
according to TE specification 15989 -  
Lettering Size= Part Number 1-15989-1

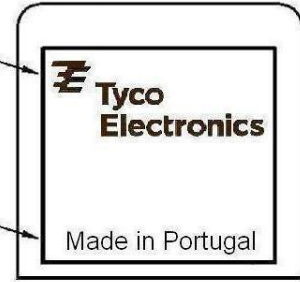
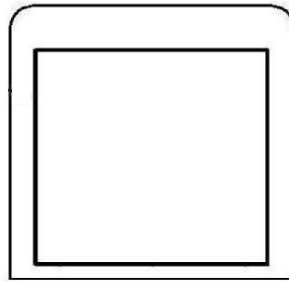

   
Country of Origin

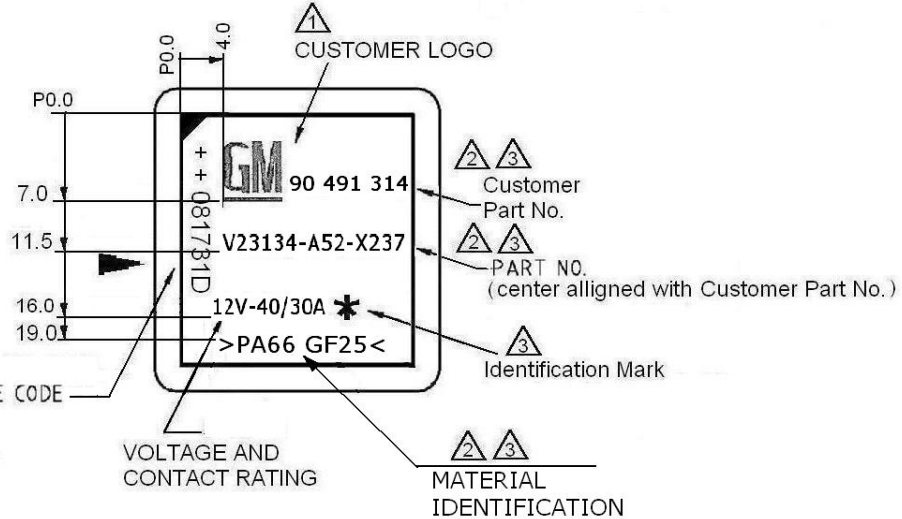

   
MANUFACTURING DATE CODE  
E.X: ++081731D  
++ = PORTUGAL  
08 = Year  
17 = Week  
3 = Day  
1 = Shift  
D = Line

-  According to ON 1396.5 - Size 2
-  Lettering Size: Arial font, Height 2.0 ± 0,1mm
-  Stamped (gasoline proof), Marking colour WHITE for black cover and BLACK for other cover colours. or Injection moulded (0,1 mm raised)
-  Stamped (gasoline proof), Marking colour WHITE for black cover and BLACK for other cover colours.

Marking should not touch the edge of marking area

 Latching nose (cover)

**Remark: If ink printed, then lettering size 1,8 +0,1 for PART NO.**

Currently Situation: All Injection molded exception Star and Date code (Black).

|      |                 |           |      |  |                   |
|------|-----------------|-----------|------|--|-------------------|
| C1   | ---             | 10MAR2016 | LSan | Date   | 09-01-13          |
| C    | ---             | 22MAY2015 | LSan | Eng.   | Sandoval 09-01-12 |
| B    | ---             | 25FEB2014 | LSan | Check  |                   |
| A    | ---             | 06DEC2013 | LSan | Appr.  |                   |
| 62   | Initial Release | 09-06-10  | LSan | <b>PE EVORA</b><br> |                   |
| 61   |                 | 09-05-27  | LSan |  |                   |
| 60   |                 | 09-05-15  | LSan |  |                   |
| 58   |                 | 09-03-25  | LSan |  |                   |
| Rev. | Change Info     | Date      | Name |  |                   |

## Marking Specification for Brazilian Market

**Z23134-A0600**

Blatt  
20/47

This controlled document is subject to change

Sin nuestra expresa autorización, queda terminantemente prohibida la reproducción total o parcial de este documento, así como su uso indebido y/o su exhibición o comunicación a terceros. De los infractores se exigirá el correspondiente resarcimiento de daños y perjuicios. Se reserva todos los derechos para el caso de la con cesión de patente de invención o el registro de Modelo industrial

Weitergabe sowie Vervielfältigung dieser Unterlage, Verwertung und Mitteilung ihres Inhaltes nicht gestattet, soweit nicht ausdrücklich zugestanden. Zuwiderhandlungen verpflichten zu Schadensersatz. Alle Rechte vorbehalten, insbesondere für den Fall der Patenterteilung oder GMA-Eintragung.

The reproduction, transmission or use of this document or its contents is not permitted without express written authority. Offenders will be liable for damages. All rights, including rights created by patent grant or registration of a utility model or design, are reserved.

**3**  
TE LOGO  
according to TE specification 15989 -  
Lettering Size= Part Number 1-15989-1

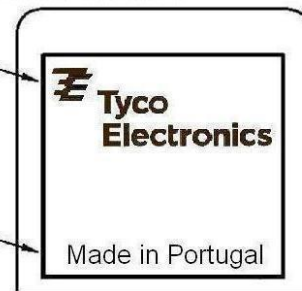
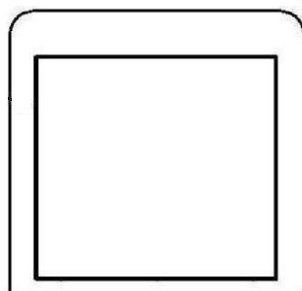

**2 3**  
Country of Origin  
Made in Portugal

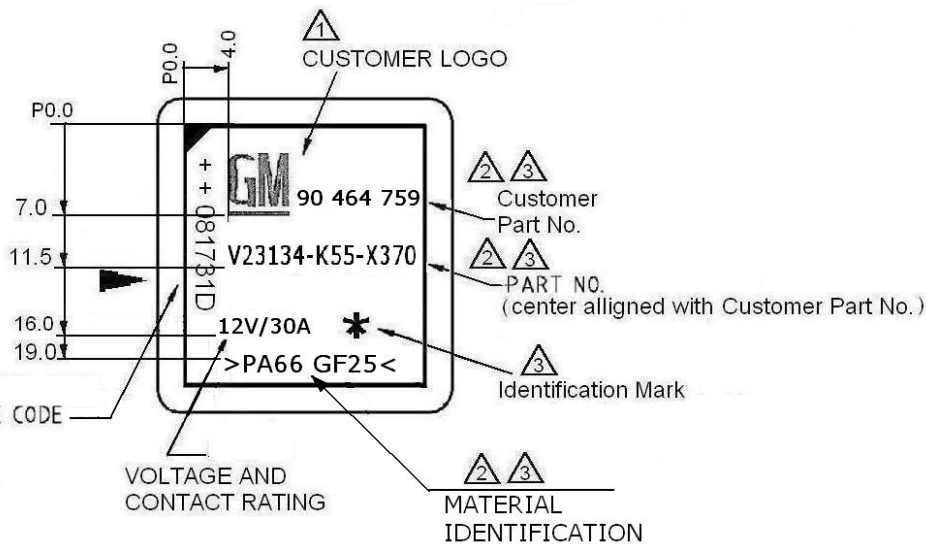

**2 4**  
MANUFACTURING DATE CODE  
E.X: ++081731D  
++ = PORTUGAL  
08 = Year  
17 = Week  
3 = Day  
1 = Shift  
D = Line

- 1** According to ON 1396.5 - Size 2
- 2** Lettering Size: Arial font, Height 2.0 ± 0,1mm
- 3** Stamped (gasoline proof), Marking colour WHITE for black cover and BLACK for other cover colours. or Injection moulded (0,1 mm raised)
- 4** Stamped (gasoline proof), Marking colour WHITE for black cover and BLACK for other cover colours.

Marking should not touch the edge of marking area

► Latching nose (cover)

**Remark: If ink printed, then lettering size 1,8 +0,1 for PART NO.**

Currently Situation: All Injection molded exception Star and Date code (Black).

|      |                 |           |      |                     |                   |
|------|-----------------|-----------|------|---------------------|-------------------|
| C1   | ---             | 10MAR2016 | LSan | Date                | 09-01-13          |
| C    | ---             | 22MAY2015 | LSan | Eng.                | Sandoval 09-01-12 |
| B    | ---             | 25FEB2014 | LSan | Check               |                   |
| A    | ---             | 06DEC2013 | LSan | Appr.               |                   |
| 62   | Initial Release | 09-06-10  | LSan | <b>PE EVORA</b><br> |                   |
| 61   |                 | 09-05-27  | LSan |                     |                   |
| 60   |                 | 09-05-15  | LSan |                     |                   |
| 58   |                 | 09-03-25  | LSan |                     |                   |
| Rev. | Change Info     | Date      | Name |                     |                   |

## Marking Specification for Brazilian Market

**Z23134-A0600**

Blatt  
21/47

This controlled document is subject to change

Sin nuestra expresa autorización, queda terminantemente prohibida la reproducción total o parcial de este documento, así como su uso indebido y/o su exhibición o comunicación a terceros. De los infractores se exigirá el correspondiente resarcimiento de daños y perjuicios. Se reserva todos los derechos para el caso de la con cesión de patente de invención o el registro de Modelo industrial

Weitergabe sowie Vervielfältigung dieser Unterlage, Verwertung und Mitteilung ihres Inhaltes nicht gestattet, soweit nicht ausdrücklich zugestanden. Zuwiderhandlungen verpflichten zu Schadensersatz. Alle Rechte vorbehalten, insbesondere für den Fall der Patenterteilung oder GMA-Eintragung.

The reproduction, transmission or use of this document or its contents is not permitted without express written authority. Offenders will be liable for damages. All rights, including rights created by patent grant or registration of a utility model or design, are reserved.

**TE LOGO**  
according to TE specification 15989 -  
Lettering Size= Part Number 1-15989-1

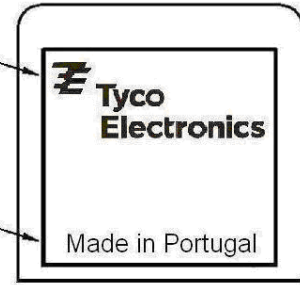
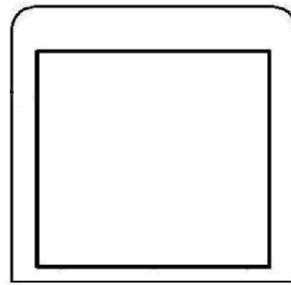

**Country of Origin**

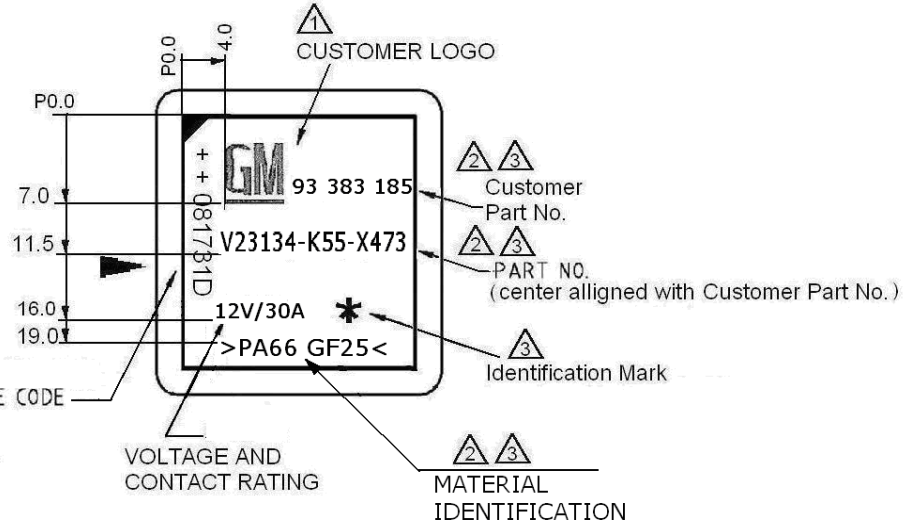

**MANUFACTURING DATE CODE**  
E.X: ++081731D  
++ = PORTUGAL  
08 = Year  
17 = Week  
3 = Day  
1 = Shift  
D = Line

- 1 According to ON 1396.5 - Size 2
- 2 Lettering Size: Arial font, Height 2.0 ± 0,1mm
- 3 Stamped (gasoline proof), Marking colour WHITE for black cover and BLACK for other cover colours. or Injection moulded (0,1 mm raised)
- 4 Stamped (gasoline proof), Marking colour WHITE for black cover and BLACK for other cover colours.

Marking should not touch the edge of marking area

▶ Latching nose (cover)

**Remark: If ink printed, then lettering size 1,8 +0,1 for PART NO.**

Currently Situation: All Injection molded exception Star and Date code (Black).

|      |                 |           |      |                 |                   |
|------|-----------------|-----------|------|-----------------|-------------------|
| C1   | ---             | 10MAR2016 | LSan | Date            | 09-01-13          |
| C    | ---             | 22MAY2015 | LSan | Eng.            | Sandoval 09-01-12 |
| B    | ---             | 25FEB2014 | LSan | Check           |                   |
| A    | ---             | 06DEC2013 | LSan | Appr.           |                   |
| 62   | Initial Release | 09-06-10  | LSan | <b>PE EVORA</b> |                   |
| 61   |                 | 09-05-27  | LSan |                 |                   |
| 60   |                 | 09-05-15  | LSan |                 |                   |
| 58   |                 | 09-03-25  | LSan |                 |                   |
| Rev. | Change Info     | Date      | Name |                 |                   |

## Marking Specification for Brazilian Market

**Z23134-A0600**

Blatt  
22/47

This controlled document is subject to change

Sin nuestra expresa autorización, queda terminantemente prohibida la reproducción total o parcial de este documento, así como su uso indebido y/o su exhibición o comunicación a terceros. De los infractores se exigirá el correspondiente resarcimiento de daños y perjuicios. Se reserva todos los derechos para el caso de la concesión de patente de invención o el registro de Modelo industrial

Weitergabe sowie Vervielfältigung dieser Unterlage, Verwertung und Mitteilung ihres Inhaltes ist nicht gestattet, soweit nicht ausdrücklich zugestanden. Zuwiderhandlungen verpflichten zu Schadensersatz. Alle Rechte vorbehalten, insbesondere für den Fall der Patenterteilung oder GMA-Eintragung.

The reproduction, transmission or use of this document or its contents is not permitted without express written authority. Offenders will be liable for damages. All rights, including rights created by patent grant or registration of a utility model or design, are reserved.

TE LOGO  
according to TE specification 15989 -  
Lettering Size= Part Number 1-15989-1

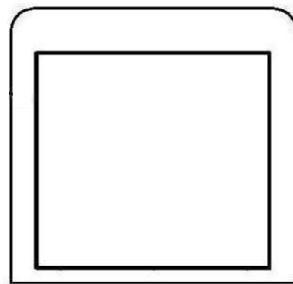

Country of Origin

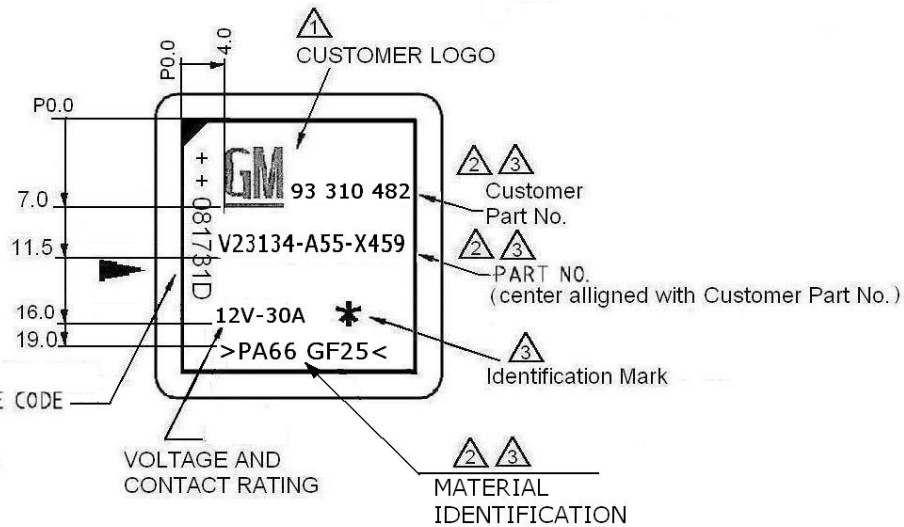

MANUFACTURING DATE CODE  
E.X: ++081731D  
++ = PORTUGAL  
08 = Year  
17 = Week  
3 = Day  
1 = Shift  
D = Line

VOLTAGE AND CONTACT RATING

MATERIAL IDENTIFICATION

- According to ON 1396.5 - Size 2
- Lettering Size: Arial font, Height 2.0 ± 0,1mm
- Stamped (gasoline proof), Marking colour WHITE for black cover and BLACK for other cover colours. or Injection moulded (0,1 mm raised)
- Stamped (gasoline proof), Marking colour WHITE for black cover and BLACK for other cover colours.

Marking should not touch the edge of marking area

Latching nose (cover)

**Remark: If ink printed, then lettering size 1,8 +0,1 for PART NO.**

Currently Situation: All Injection molded exception Star and Date code (Black).

|      |                 |           |      |                 |                   |
|------|-----------------|-----------|------|-----------------|-------------------|
| C1   | ---             | 10MAR2016 | LSan | Date            | 09-01-13          |
| C    | ---             | 22MAY2015 | LSan | Eng.            | Sandoval 09-01-12 |
| B    | ---             | 25FEB2014 | LSan | Check           |                   |
| A    | ---             | 06DEC2013 | LSan | Appr.           |                   |
| 62   | Initial Release | 09-06-10  | LSan | <b>PE EVORA</b> |                   |
| 61   |                 | 09-05-27  | LSan |                 |                   |
| 60   |                 | 09-05-15  | LSan |                 |                   |
| 58   |                 | 09-03-25  | LSan |                 |                   |
| Rev. | Change Info     | Date      | Name |                 |                   |

## Marking Specification for Brazilian Market

**Z23134-A0600**

Blatt  
23/47

This controlled document is subject to change

Sin nuestra expresa autorización, queda terminantemente prohibida la reproducción total o parcial de este documento, así como su uso indebido y/o su exhibición o comunicación a terceros. De los infractores se exigirá el correspondiente resarcimiento de daños y perjuicios. Se reserva todos los derechos para el caso de la con cesión de patente de invención o el registro de Modelo industrial

Weitergabe sowie Vervielfältigung dieser Unterlage, Verwertung und Mitteilung ihres Inhaltes ist nicht gestattet, soweit nicht ausdrücklich zugestanden. Zuwiderhandlungen verpflichten zu Schadensersatz. Alle Rechte vorbehalten, insbesondere für den Fall der Patenterteilung oder GMA-Eintragung.

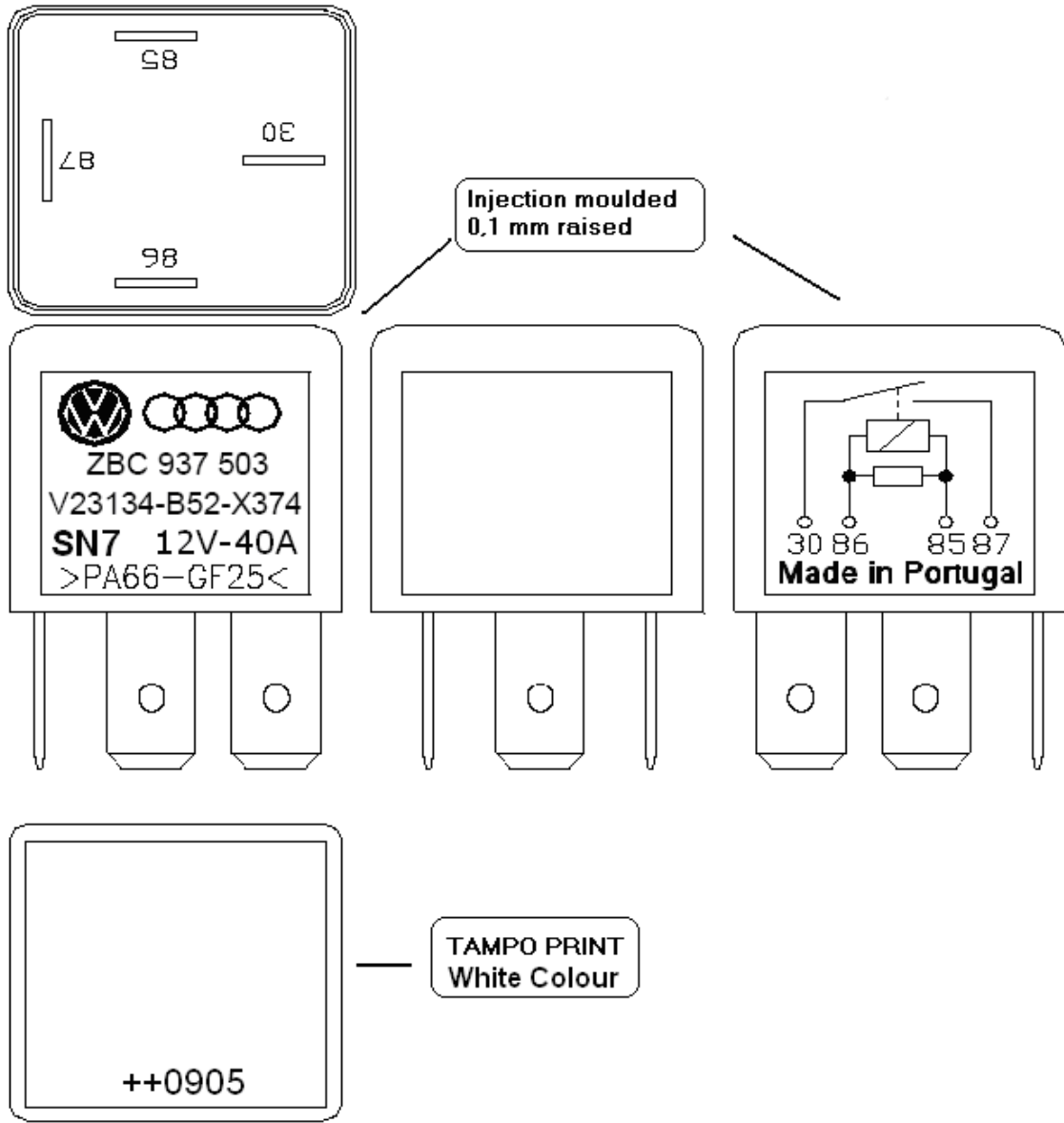

Remark: For more information to see marking specification Z23134-A0063

The reproduction, transmission or use of this document or its contents is not permitted without express written authority. Offenders will be liable for damages. All rights, including rights created by patent grant or registration of a utility model or design, are reserved.

|      |                 |           |      |   |                   |
|------|-----------------|-----------|------|---|-------------------|
| C1   | ---             | 10MAR2016 | LSan | Date  | 09-01-13          |
| C    | ---             | 22MAY2015 | LSan | Eng.  | Sandoval 09-01-12 |
| B    | ---             | 25FEB2014 | LSan | Check   |                   |
| A    | ---             | 06DEC2013 | LSan | Appr.   |                   |
| 62   | Initial Release | 09-06-10  | LSan | <b>PE EVORA</b>   |                   |
| 61   |                 | 09-05-27  | LSan |   |                   |
| 60   |                 | 09-05-15  | LSan |  |                   |
| 58   |                 | 09-03-25  | LSan |   |                   |
| Rev. | Change Info     | Date      | Name |   |                   |

## Marking Specification for Brazilian Market

Z23134-A0600

Blatt  
24/47

This controlled document is subject to change

Sin nuestra expresa autorización, queda terminantemente prohibida la reproducción total o parcial de este documento, así como su uso indebido y/o su exhibición o comunicación a terceros. De los infractores se exigirá el correspondiente resarcimiento de daños y perjuicios. Se reserva todos los derechos para el caso de la concesión de patente de invención o el registro de Modelo industrial.

Weitergabe sowie Vervielfältigung dieser Unterlage, Verwertung und Mitteilung ihres Inhaltes ist nicht gestattet, soweit nicht ausdrücklich zugestanden. Zuwiderhandlungen verpflichten zu Schadensersatz. Alle Rechte vorbehalten, insbesondere für den Fall der Patenterteilung oder GMA-Eintragung.

The reproduction, transmission or use of this document or its contents is not permitted without express written authority. Offenders will be liable for damages. All rights, including rights created by patent grant or registration of a utility model or design, are reserved.

# V23134-A0053-X412 (V23134A0053X412P)

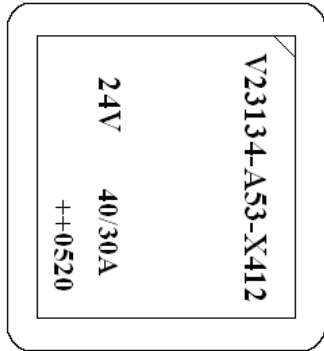
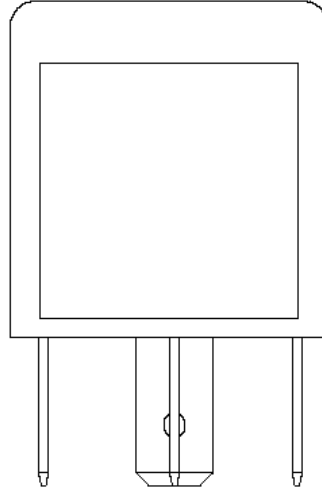
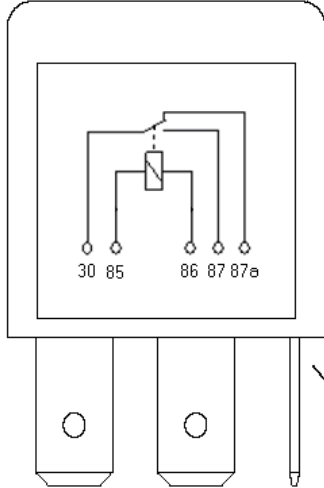
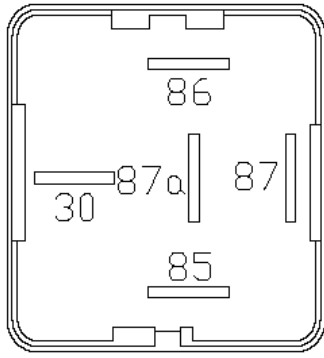

Injection moulded  
0.1 mm raised

TAMPO PRINT  
White Colour

|      |                 |           |      |                 |                   |
|------|-----------------|-----------|------|-----------------|-------------------|
| C1   | ---             | 10MAR2016 | LSan | Date            | 09-01-13          |
| C    | ---             | 22MAY2015 | LSan | Eng.            | Sandoval 09-01-12 |
| B    | ---             | 25FEB2014 | LSan | Check           |                   |
| A    | ---             | 06DEC2013 | LSan | Appr.           |                   |
| 62   | Initial Release | 09-06-10  | LSan | <b>PE EVORA</b> |                   |
| 61   |                 | 09-05-27  | LSan |                 |                   |
| 60   |                 | 09-05-15  | LSan |                 |                   |
| 58   |                 | 09-03-25  | LSan |                 |                   |
| Rev. | Change Info     | Date      | Name |                 |                   |

## Marking Specification for Brazilian Market

V23134-A0600

Blatt  
25/47

This controlled document is subject to change

Sin nuestra expresa autorización, queda terminantemente prohibida la reproducción total o parcial de este documento, así como su uso indebido y/o su exhibición o comunicación a terceros. De los infractores se exigirá el correspondiente resarcimiento de daños y perjuicios. Se reserva todos los derechos para el caso de la con cesión de patente de invención o el registro de Modelo industrial

Weitergabe sowie Vervielfältigung dieser Unterlage, Verwertung und Mitteilung ihres Inhaltes ist nicht gestattet, soweit nicht ausdrücklich zugestanden. Zuwiderhandlungen verpflichten zu Schadensersatz. Alle Rechte vorbehalten, insbesondere für den Fall der Patenterteilung oder GMA-Eintragung.

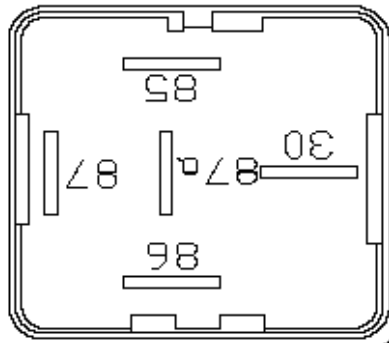

Injection moulded  
0,1 mm raised

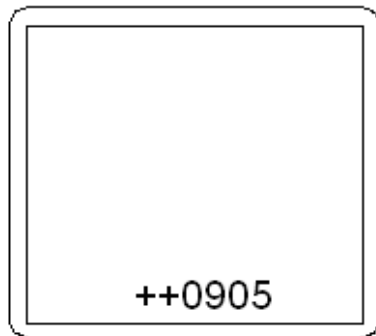
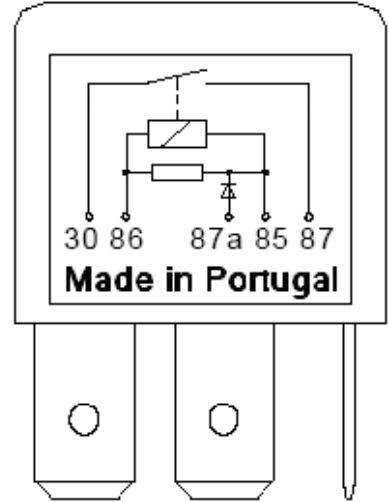
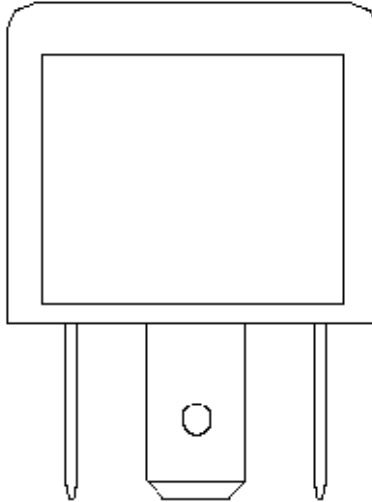
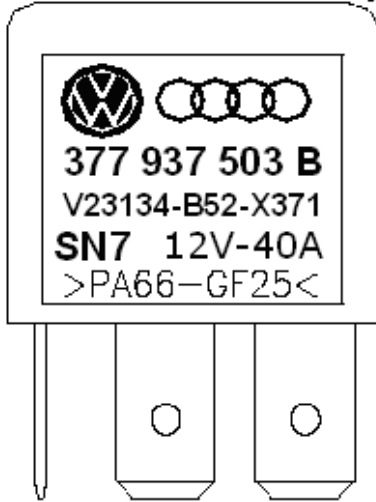

TAMPO PRINT  
White Colour

Remark: For more information to see marking specification Z23134-A0063

The reproduction, transmission or use of this document or its contents is not permitted without express written authority. Offenders will be liable for damages. All rights, including rights created by patent grant or registration of a utility model or design, are reserved.

|      |                 |           |      |  |                   |
|------|-----------------|-----------|------|--|-------------------|
| C1   | ---             | 10MAR2016 | LSan | Date   | 09-01-13          |
| C    | ---             | 22MAY2015 | LSan | Eng.   | Sandoval 09-01-12 |
| B    | ---             | 25FEB2014 | LSan | Check  |                   |
| A    | ---             | 06DEC2013 | LSan | Appr.  |                   |
| 62   | Initial Release | 09-06-10  | LSan | <b>PE EVORA</b><br> |                   |
| 61   |                 | 09-05-27  | LSan |  |                   |
| 60   |                 | 09-05-15  | LSan |  |                   |
| 58   |                 | 09-03-25  | LSan |  |                   |
| Rev. | Change Info     | Date      | Name |  |                   |

## Marking Specification for Brazilian Market

Z23134-A0600

Blatt  
26/47

This controlled document is subject to change

Sin nuestra expresa autorización, queda terminantemente prohibida la reproducción total o parcial de este documento, así como su uso indebido y/o su exhibición o comunicación a terceros. De los infractores se exigirá el correspondiente resarcimiento de daños y perjuicios. Se reserva todos los derechos para el caso de la con cesión de patente de invención o el registro de Modelo industrial

Weitergabe sowie Vervielfältigung dieser Unterlage, Verwertung und Mitteilung ihres Inhaltes nicht gestattet, soweit nicht ausdrücklich zugestanden. Zuwiderhandlungen verpflichten zu Schadenersatz. Alle Rechte vorbehalten, insbesondere für den Fall der Patenterteilung oder GMA-Eintragung.

The reproduction, transmission or use of this document or its contents is not permitted without express written authority. Offenders will be liable for damages. All rights, including rights created by patent grant or registration of a utility model or design, are reserved.

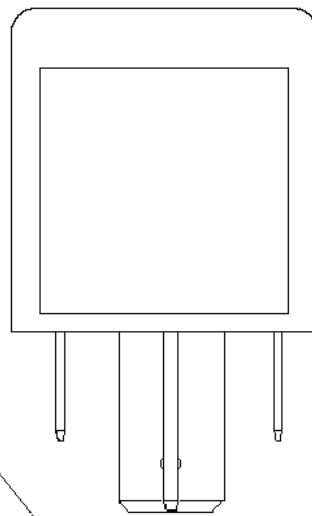
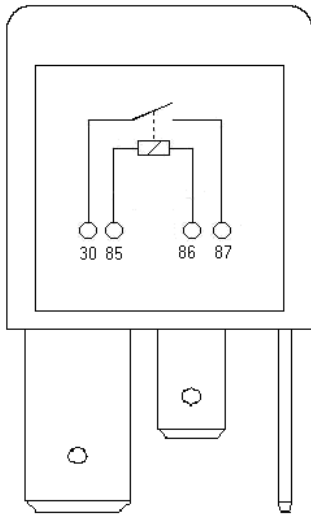
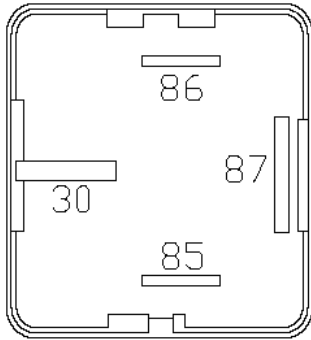

Injection moulded  
0.1 mm raised

To see also Marking Specification  
Z23134-A2002

TAMPO PRINT  
White Colour

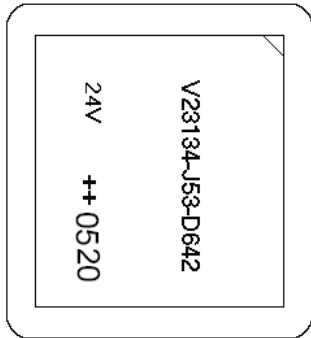

|      |                 |           |      |  |                   |
|------|-----------------|-----------|------|--|-------------------|
| C1   | ---             | 10MAR2016 | LSan | Date   | 09-01-13          |
| C    | ---             | 22MAY2015 | LSan | Eng.   | Sandoval 09-01-12 |
| B    | ---             | 25FEB2014 | LSan | Check  |                   |
| A    | ---             | 06DEC2013 | LSan | Appr.  |                   |
| 62   | Initial Release | 09-06-10  | LSan | <b>PE EVORA</b><br> |                   |
| 61   |                 | 09-05-27  | LSan |  |                   |
| 60   |                 | 09-05-15  | LSan |  |                   |
| 58   |                 | 09-03-25  | LSan |  |                   |
| Rev. | Change Info     | Date      | Name |  |                   |

## Marking Specification for Brazilian Market

Z23134-A0600

Blatt  
27/47

This controlled document is subject to change

Sin nuestra expresa autorización, queda terminantemente prohibida la reproducción total o parcial de este documento, así como su uso indebido y/o su exhibición o comunicación a terceros. De los infractores se exigirá el correspondiente resarcimiento de daños y perjuicios. Se reserva todos los derechos para el caso de la con cesión de patente de invención o el registro de Modelo industrial

Weitergabe sowie Vervielfältigung dieser Unterlage, Verbreitung und Mitteilung ihres Inhaltes nicht gestattet, soweit nicht ausdrücklich zugestanden. Zuwiderhandlungen verpflichten zu Schadenersatz. Alle Rechte vorbehalten, insbesondere für den Fall der Patenterteilung oder GMA-Eintragung.

The reproduction, transmission or use of this document or its contents is not permitted without express written authority. Offenders will be liable for damages. All rights, including rights created by patent grant or registration of a utility model or design, are reserved.

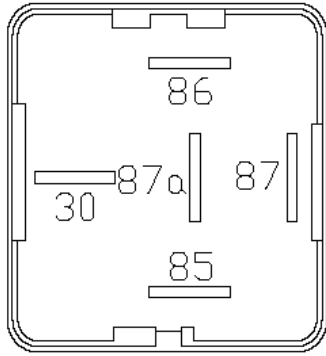

## V23134-A0053-X414 (V23134A0053X414P)

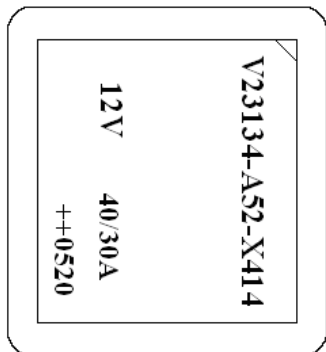
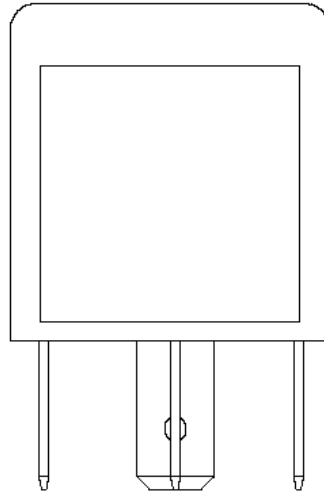
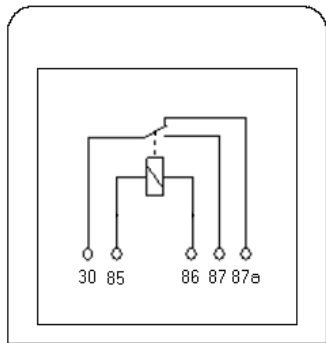

Injection moulded  
0.1 mm raised

TAMPO PRINT  
White Colour

|      |                 |           |      |  |                   |
|------|-----------------|-----------|------|--|-------------------|
| C1   | ---             | 10MAR2016 | LSan | Date   | 09-01-13          |
| C    | ---             | 22MAY2015 | LSan | Eng.   | Sandoval 09-01-12 |
| B    | ---             | 25FEB2014 | LSan | Check  |                   |
| A    | ---             | 06DEC2013 | LSan | Appr.  |                   |
| 62   | Initial Release | 09-06-10  | LSan | <b>PE EVORA</b><br> |                   |
| 61   |                 | 09-05-27  | LSan |  |                   |
| 60   |                 | 09-05-15  | LSan |  |                   |
| 58   |                 | 09-03-25  | LSan |  |                   |
| Rev. | Change Info     | Date      | Name |  |                   |

## Marking Specification for Brazilian Market

V23134-A0600

Blatt  
28/47

This controlled document is subject to change

Sin nuestra expresa autorización, queda terminantemente prohibida la reproducción total o parcial de este documento, así como su uso indebido y/o su exhibición o comunicación a terceros. De los infractores se exigirá el correspondiente resarcimiento de daños y perjuicios. Se reserva todos los derechos para el caso de la con cesión de patente de invención o el registro de Modelo industrial

Weitergabe sowie Vervielfältigung dieser Unterlage, Wertung und Mitteilung ihres Inhaltes nicht gestattet, soweit nicht ausdrücklich zugestanden. Zuwiderhandlungen verpflichten zu Schadenersatz. Alle Rechte vorbehalten, insbesondere für den Fall der Patenterteilung oder GMA-Eintragung.

The reproduction, transmission or use of this document or its contents is not permitted without express written authority. Offenders will be liable for damages. All rights, including rights created by patent grant or registration of a utility model or design, are reserved.

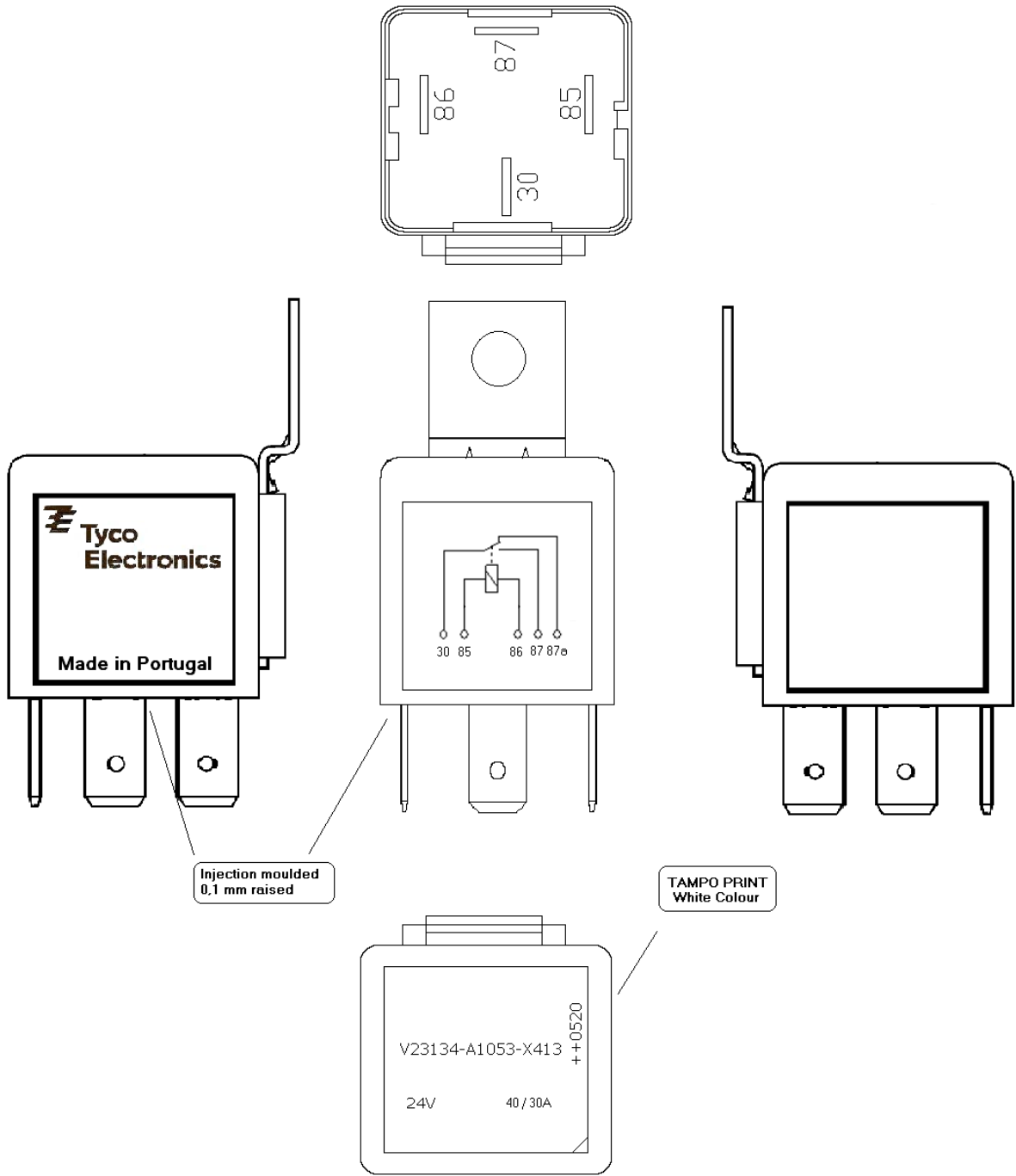

|      |                 |           |      |  |                   |
|------|-----------------|-----------|------|--|-------------------|
| C1   | ---             | 10MAR2016 | LSan | Date   | 09-01-13          |
| C    | ---             | 22MAY2015 | LSan | Eng.   | Sandoval 09-01-12 |
| B    | ---             | 25FEB2014 | LSan | Check  |                   |
| A    | ---             | 06DEC2013 | LSan | Appr.  |                   |
| 62   | Initial Release | 09-06-10  | LSan | <b>PE EVORA</b><br> |                   |
| 61   |                 | 09-05-27  | LSan |  |                   |
| 60   |                 | 09-05-15  | LSan |  |                   |
| 58   |                 | 09-03-25  | LSan |  |                   |
| Rev. | Change Info     | Date      | Name |  |                   |

## Marking Specification for Brazilian Market

**Z23134-A0600**

Blatt  
29/47

This controlled document is subject to change

Sin nuestra expresa autorización, queda terminantemente prohibida la reproducción total o parcial de este documento, así como su uso indebido y/o su exhibición o comunicación a terceros. De los infractores se exigirá el correspondiente resarcimiento de daños y perjuicios. Se reserva todos los derechos para el caso de la con cesión de patente de invención o el registro de Modelo industrial

Weitergabe sowie Vervielfältigung dieser Unterlage, Verwertung und Mitteilung ihres Inhaltes nicht gestattet, soweit nicht ausdrücklich zugestanden. Zuwiderhandlungen verpflichten zu Schadensersatz. Alle Rechte vorbehalten, insbesondere für den Fall der Patenterteilung oder GMA-Eintragung.

The reproduction, transmission or use of this document or its contents is not permitted without express written authority. Offenders will be liable for damages. All rights, including rights created by patent grant or registration of a utility model or design, are reserved.

# V23134-B0055-X605 (V23134B0055Y009P)

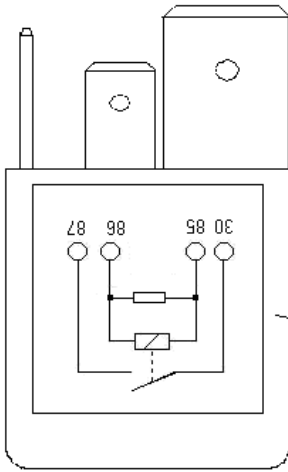

TAMPO PRINT  
White Colour

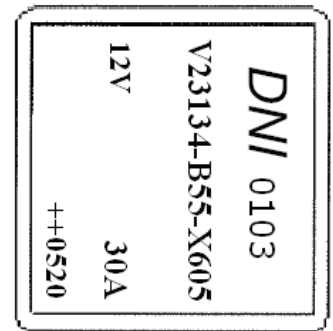
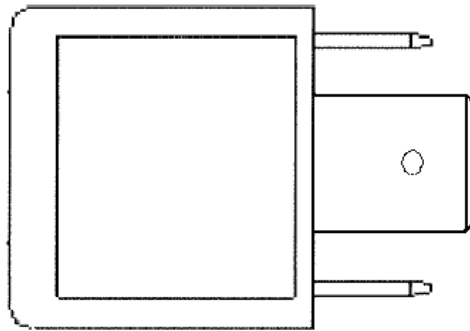
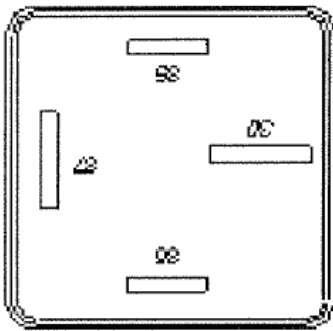

Injection moulded  
0,1 mm raised

|      |                 |           |      |                 |                   |
|------|-----------------|-----------|------|-----------------|-------------------|
| C1   | ---             | 10MAR2016 | LSan | Date            | 09-01-13          |
| C    | ---             | 22MAY2015 | LSan | Eng.            | Sandoval 09-01-12 |
| B    | ---             | 25FEB2014 | LSan | Check           |                   |
| A    | ---             | 06DEC2013 | LSan | Appr.           |                   |
| 62   | Initial Release | 09-06-10  | LSan | <b>PE EVORA</b> |                   |
| 61   |                 | 09-05-27  | LSan |                 |                   |
| 60   |                 | 09-05-15  | LSan |                 |                   |
| 58   |                 | 09-03-25  | LSan |                 |                   |
| Rev. | Change Info     | Date      | Name |                 |                   |

## Marking Specification for Brazilian Market

Z23134-A0600

Blatt  
30/47

This controlled document is subject to change

Sin nuestra expresa autorización, queda terminantemente prohibida la reproducción total o parcial de este documento, así como su uso indebido y/o su exhibición o comunicación a terceros. De los infractores se exigirá el correspondiente resarcimiento de daños y perjuicios. Se reserva todos los derechos para el caso de la con cesión de patente de invención o el registro de Modelo industrial

Weitergabe sowie Vervielfältigung dieser Unterlage, Verwertung und Mitteilung ihres Inhaltes nicht gestattet, soweit nicht ausdrücklich zugestanden. Zuwiderhandlungen verpflichten zu Schadenersatz. Alle Rechte vorbehalten, insbesondere für den Fall der Patenterteilung oder GMA-Eintragung.

The reproduction, transmission or use of this document or its contents is not permitted without express written authority. Offenders will be liable for damages. All rights, including rights created by patent grant or registration of a utility model or design, are reserved.

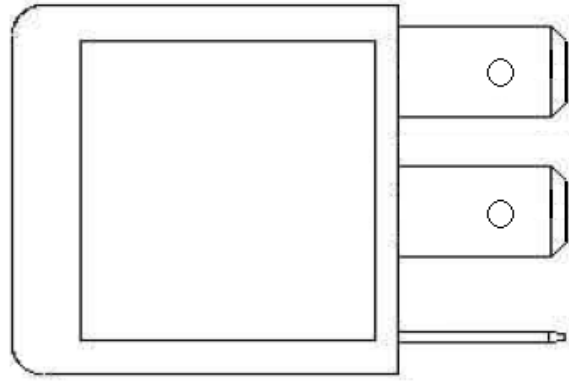
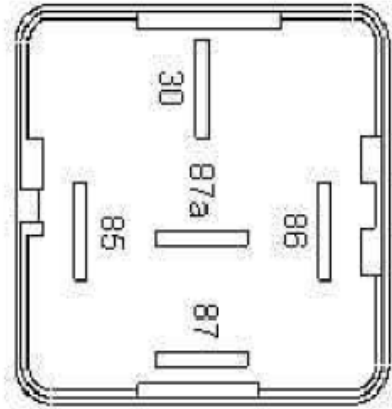

Injection moulded  
0,1 mm raised

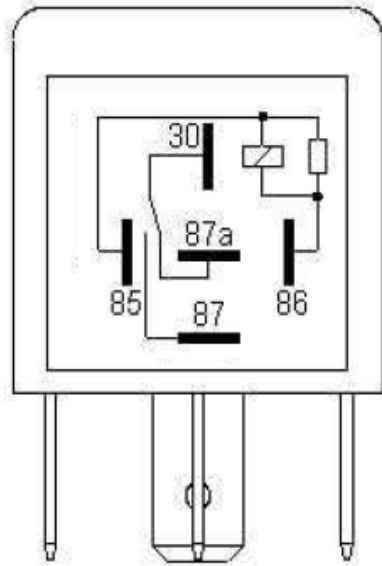

TAMPO PRINT  
White colour

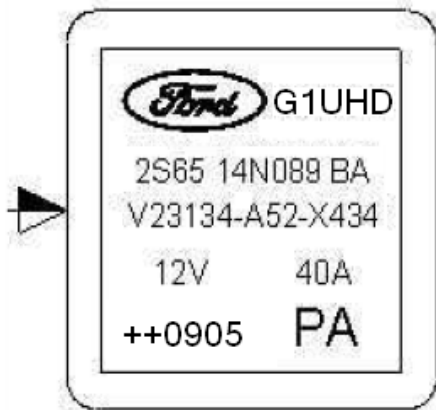

|      |                 |           |      |  |                   |
|------|-----------------|-----------|------|--|-------------------|
| C1   | ---             | 10MAR2016 | LSan | Date   | 09-01-13          |
| C    | ---             | 22MAY2015 | LSan | Eng.   | Sandoval 09-01-12 |
| B    | ---             | 25FEB2014 | LSan | Check  |                   |
| A    | ---             | 06DEC2013 | LSan | Appr.  |                   |
| 62   | Initial Release | 09-06-10  | LSan | <b>PE EVORA</b><br> |                   |
| 61   |                 | 09-05-27  | LSan |  |                   |
| 60   |                 | 09-05-15  | LSan |  |                   |
| 58   |                 | 09-03-25  | LSan |  |                   |
| Rev. | Change Info     | Date      | Name |  |                   |

## Marking Specification for Brazilian Market

Z23134-A0600

Blatt  
31/47

This controlled document is subject to change

Sin nuestra expresa autorización, queda terminantemente prohibida la reproducción total o parcial de este documento, así como su uso indebido y/o su exhibición o comunicación a terceros. De los infractores se exigirá el correspondiente resarcimiento de daños y perjuicios. Se reserva todos los derechos para el caso de la con cesión de patente de invención o el registro de Modelo industrial

Weitergabe sowie Vervielfältigung dieser Unterlage, Verwertung und Mitteilung ihres Inhaltes nicht gestattet, soweit nicht ausdrücklich zugestanden. Zuwiderhandlungen verpflichten zu Schadensersatz. Alle Rechte vorbehalten, insbesondere für den Fall der Patenterteilung oder GMA-Eintragung.

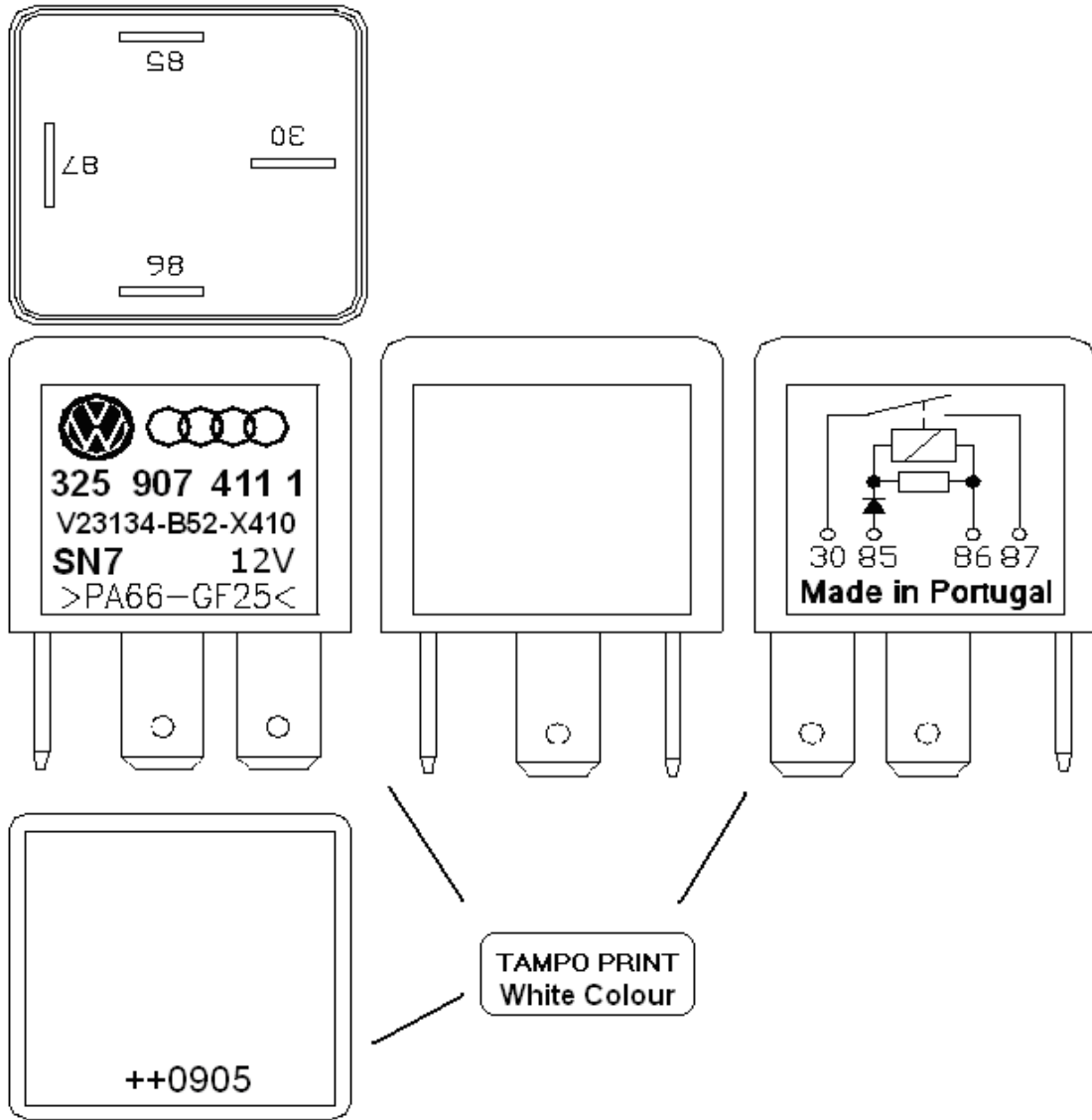

Remark: For more information to see marking specification Z23134-A0063

The reproduction, transmission or use of this document or its contents is not permitted without express written authority. Offenders will be liable for damages. All rights, including rights created by patent grant or registration of a utility model or design, are reserved.

|      |                 |           |      |  |                   |
|------|-----------------|-----------|------|--|-------------------|
| C1   | ---             | 10MAR2016 | LSan | Date   | 09-01-13          |
| C    | ---             | 22MAY2015 | LSan | Eng.   | Sandoval 09-01-12 |
| B    | ---             | 25FEB2014 | LSan | Check  |                   |
| A    | ---             | 06DEC2013 | LSan | Appr.  |                   |
| 62   | Initial Release | 09-06-10  | LSan | <b>PE EVORA</b><br> |                   |
| 61   |                 | 09-05-27  | LSan |  |                   |
| 60   |                 | 09-05-15  | LSan |  |                   |
| 58   |                 | 09-03-25  | LSan |  |                   |
| Rev. | Change Info     | Date      | Name |  |                   |

## Marking Specification for Brazilian Market

Z23134-A0600

Blatt  
32/47

This controlled document is subject to change

Sin nuestra expresa autorización, queda terminantemente prohibida la reproducción total o parcial de este documento, así como su uso indebido y/o su exhibición o comunicación a terceros. De los infractores se exigirá el correspondiente resarcimiento de daños y perjuicios. Se reserva todos los derechos para el caso de la con cesión de patente de invención o el registro de Modelo industrial

Weitergabe sowie Vervielfältigung dieser Unterlage, Wertung und Mitteilung ihres Inhaltes nicht gestattet, soweit nicht ausdrücklich zugestanden. Zuwiderhandlungen verpflichten zu Schadenersatz. Alle Rechte vorbehalten, insbesondere für den Fall der Patenterteilung oder GMA-Eintragung.

The reproduction, transmission or use of this document or its contents is not permitted without express written authority. Offenders will be liable for damages. All rights, including rights created by patent grant or registration of a utility model or design, are reserved.

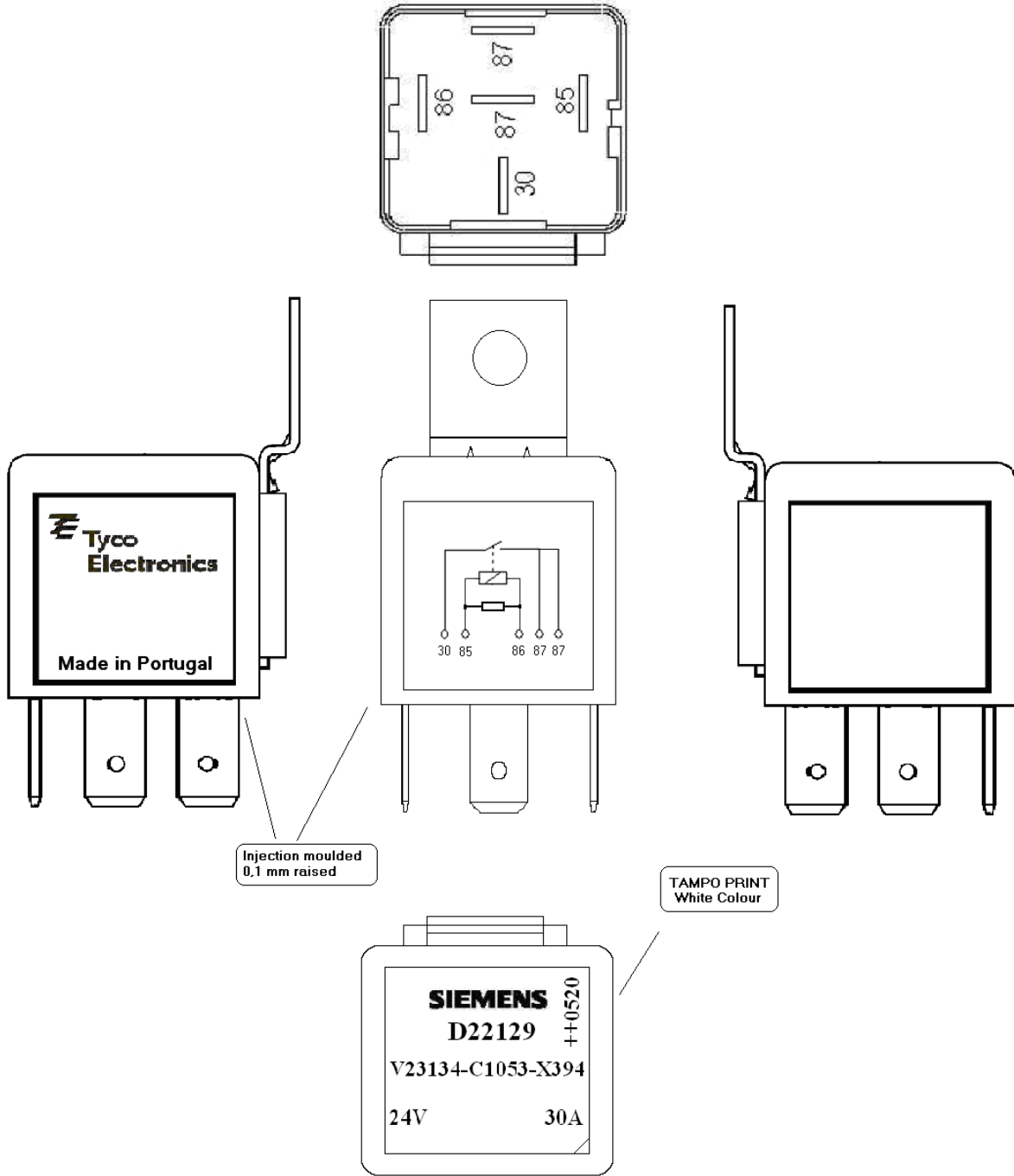

|      |                 |           |      |  |                   |
|------|-----------------|-----------|------|--|-------------------|
| C1   | ---             | 10MAR2016 | LSan | Date   | 09-01-13          |
| C    | ---             | 22MAY2015 | LSan | Eng.   | Sandoval 09-01-12 |
| B    | ---             | 25FEB2014 | LSan | Check  |                   |
| A    | ---             | 06DEC2013 | LSan | Appr.  |                   |
| 62   | Initial Release | 09-06-10  | LSan | <b>PE EVORA</b><br> |                   |
| 61   |                 | 09-05-27  | LSan |  |                   |
| 60   |                 | 09-05-15  | LSan |  |                   |
| 58   |                 | 09-03-25  | LSan |  |                   |
| Rev. | Change Info     | Date      | Name |  |                   |

## Marking Specification for Brazilian Market

Z23134-A0600

Blatt  
33/47

This controlled document is subject to change

Sin nuestra expresa autorización, queda terminantemente prohibida la reproducción total o parcial de este documento, así como su uso indebido y/o su exhibición o comunicación a terceros. De los infractores se exigirá el correspondiente resarcimiento de daños y perjuicios. Se reserva todos los derechos para el caso de la con cesión de patente de invención o el registro de Modelo industrial

Weitergabe sowie Vervielfältigung dieser Unterlage, Verwertung und Mitteilung ihres Inhaltes nicht gestattet, soweit nicht ausdrücklich zugestanden. Zuwiderhandlungen verpflichten zu Schadensersatz. Alle Rechte vorbehalten, insbesondere für den Fall der Patenterteilung oder GMA-Eintragung.

The reproduction, transmission or use of this document or its contents is not permitted without express written authority. Offenders will be liable for damages. All rights, including rights created by patent grant or registration of a utility model or design, are reserved.

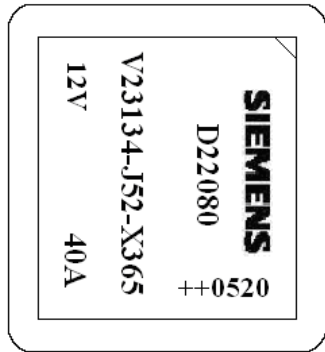
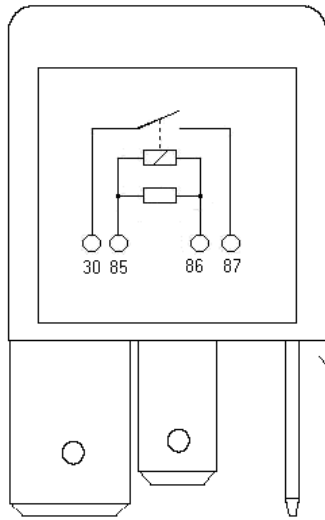
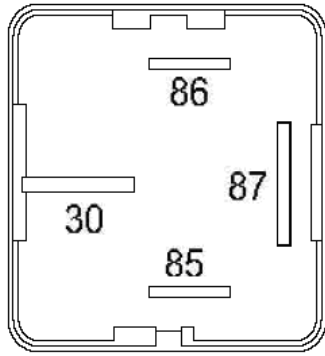

TAMPO PRINT  
Black Colour

Injection moulded  
0,1 mm raised

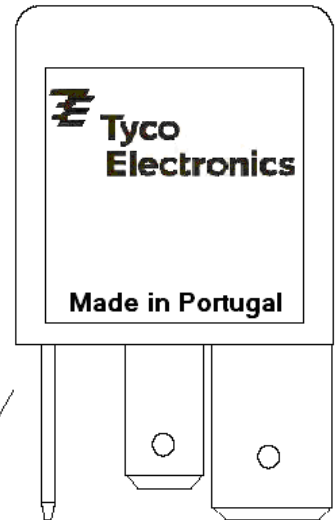

|      |                 |           |      |  |                   |
|------|-----------------|-----------|------|--|-------------------|
| C1   | ---             | 10MAR2016 | LSan | Date   | 09-01-13          |
| C    | ---             | 22MAY2015 | LSan | Eng.   | Sandoval 09-01-12 |
| B    | ---             | 25FEB2014 | LSan | Check  |                   |
| A    | ---             | 06DEC2013 | LSan | Appr.  |                   |
| 62   | Initial Release | 09-06-10  | LSan | <b>PE EVORA</b><br> |                   |
| 61   |                 | 09-05-27  | LSan |  |                   |
| 60   |                 | 09-05-15  | LSan |  |                   |
| 58   |                 | 09-03-25  | LSan |  |                   |
| Rev. | Change Info     | Date      | Name |  |                   |

## Marking Specification for Brazilian Market

Z23134-A0600

Blatt  
34/47

This controlled document is subject to change

Sin nuestra expresa autorización, queda terminantemente prohibida la reproducción total o parcial de este documento, así como su uso indebido y/o su exhibición o comunicación a terceros. De los infractores se exigirá el correspondiente resarcimiento de daños y perjuicios. Se reserva todos los derechos para el caso de la con cesión de patente de invención o el registro de Modelo industrial

Weitergabe sowie Vervielfältigung dieser Unterlage, Verwertung und Mitteilung ihres Inhaltes nicht gestattet, soweit nicht ausdrücklich zugestanden. Zuwiderhandlungen verpflichten zu Schadensersatz. Alle Rechte vorbehalten, insbesondere für den Fall der Patenterteilung oder GMA-Eintragung.

The reproduction, transmission or use of this document or its contents is not permitted without express written authority. Offenders will be liable for damages. All rights, including rights created by patent grant or registration of a utility model or design, are reserved.

**3**  
TE LOGO  
according to TE specification 15989 -  
Lettering Size= Part Number 1-15989-1

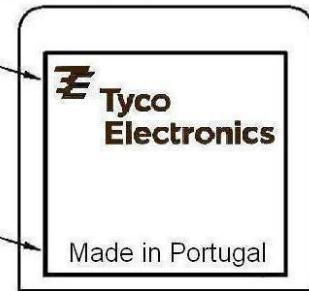
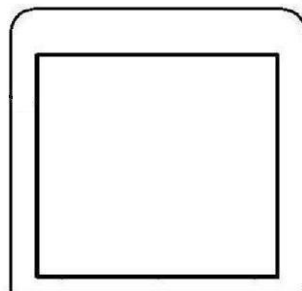

**2 3**  
Country of Origin  
Made in Portugal

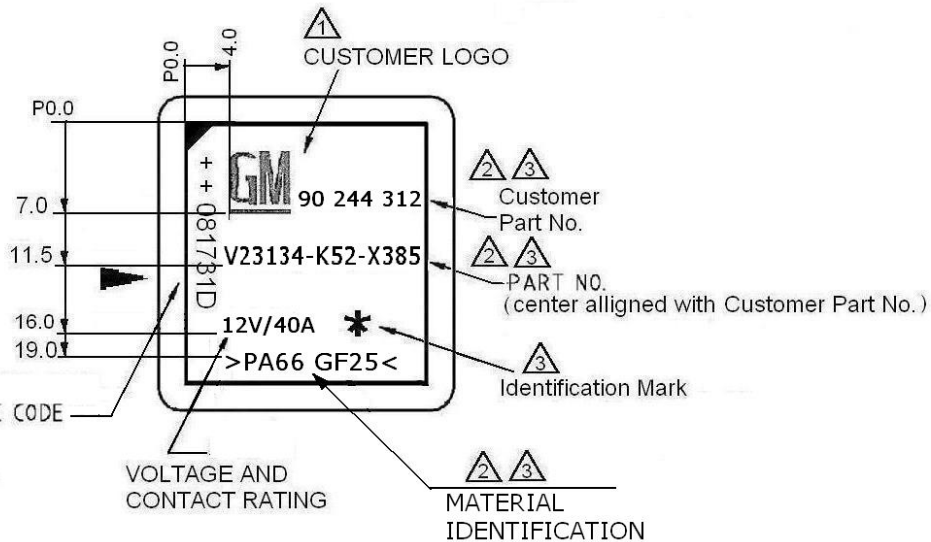

**2 4**  
MANUFACTURING DATE CODE  
E.X: ++081731D  
++ = PORTUGAL  
08 = Year  
17 = Week  
3 = Day  
1 = Shift  
D = Line

- 1** According to ON 1396.5 - Size 2
- 2** Lettering Size: Arial font, Height 2.0 ± 0,1mm
- 3** Stamped (gasoline proof), Marking colour WHITE for black cover and BLACK for other cover colours. or Injection moulded (0,1 mm raised)
- 4** Stamped (gasoline proof), Marking colour WHITE for black cover and BLACK for other cover colours.

Marking should not touch the edge of marking area

▶ Latching nose (cover)

**Remark: If ink printed, then lettering size 1,8 +0,1 for PART NO.**

Currently Situation: Tyco Logo and Made in Portugal injection molded, Relay specifications and Star (White) and Date code (Yellow) printed.

|      |                 |           |      |                     |                   |
|------|-----------------|-----------|------|---------------------|-------------------|
| C1   | ---             | 10MAR2016 | LSan | Date                | 09-01-13          |
| C    | ---             | 22MAY2015 | LSan | Eng.                | Sandoval 09-01-12 |
| B    | ---             | 25FEB2014 | LSan | Check               |                   |
| A    | ---             | 06DEC2013 | LSan | Appr.               |                   |
| 62   | Initial Release | 09-06-10  | LSan | <b>PE EVORA</b><br> |                   |
| 61   |                 | 09-05-27  | LSan |                     |                   |
| 60   |                 | 09-05-15  | LSan |                     |                   |
| 58   |                 | 09-03-25  | LSan |                     |                   |
| Rev. | Change Info     | Date      | Name |                     |                   |

## Marking Specification for Brazilian Market

**Z23134-A0600**

Blatt  
35/47

This controlled document is subject to change

Sin nuestra expresa autorización, queda terminantemente prohibida la reproducción total o parcial de este documento, así como su uso indebido y/o su exhibición o comunicación a terceros. De los infractores se exigirá el correspondiente resarcimiento de daños y perjuicios. Se reserva todos los derechos para el caso de la con cesión de patente de invención o el registro de Modelo industrial

Weitergabe sowie Vervielfältigung dieser Unterlage, Verwertung und Mitteilung ihres Inhaltes nicht gestattet, soweit nicht ausdrücklich zugestanden. Zuwiderhandlungen verpflichten zu Schadenersatz. Alle Rechte vorbehalten, insbesondere für den Fall der Patenterteilung oder G.M.-Eintragung.

The reproduction, transmission or use of this document or its contents is not permitted without express written authority. Offenders will be liable for damages. All rights, including rights created by patent grant or registration of a utility model or design, are reserved.

 TE LOGO  
according to TE specification 15989 -  
Lettering Size= Part Number 1-15989-1

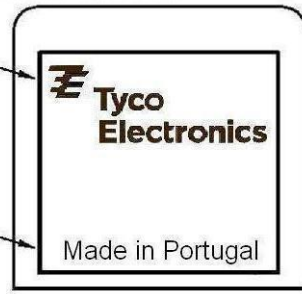
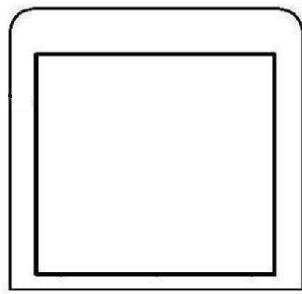

   
Country of Origin

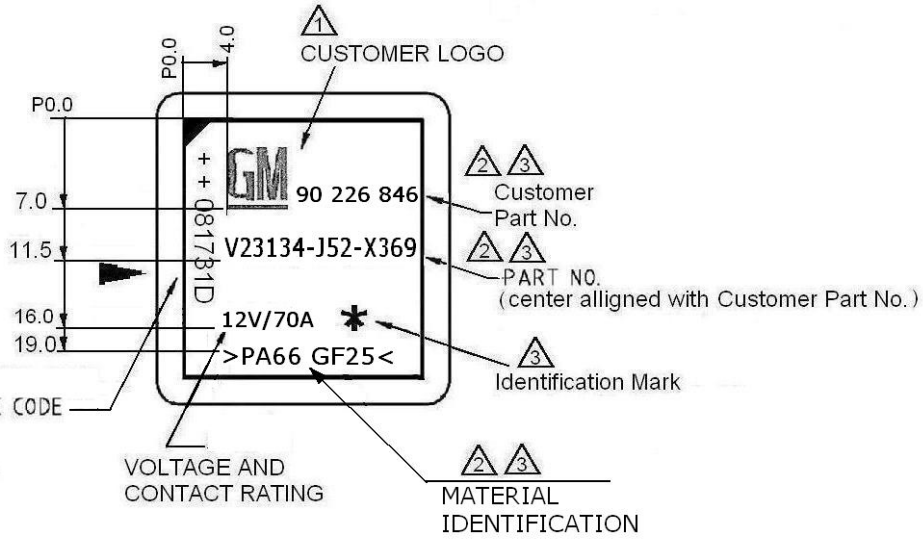

   
MANUFACTURING DATE CODE  
E.X: ++081731D  
++ = PORTUGAL  
08 = Year  
17 = Week  
3 = Day  
1 = Shift  
D = Line

-  According to ON 1396.5 - Size 2
-  Lettering Size: Arial font, Height 2.0 ± 0,1mm
-  Stamped (gasoline proof), Marking colour WHITE for black cover and BLACK for other cover colours. or Injection moulded (0,1 mm raised)
-  Stamped (gasoline proof), Marking colour WHITE for black cover and BLACK for other cover colours.

Marking should not touch the edge of marking area

 Latching nose (cover)

**Remark: If ink printed, then lettering size 1,8 +0,1 for PART NO.**

Currently Situation: All Injection molded exception Star and Date code (Black).

|      |                 |           |      |  |                   |
|------|-----------------|-----------|------|--|-------------------|
| C1   | ---             | 10MAR2016 | LSan | Date   | 09-01-13          |
| C    | ---             | 22MAY2015 | LSan | Eng.   | Sandoval 09-01-12 |
| B    | ---             | 25FEB2014 | LSan | Check  |                   |
| A    | ---             | 06DEC2013 | LSan | Appr.  |                   |
| 62   | Initial Release | 09-06-10  | LSan | <b>PE EVORA</b><br> |                   |
| 61   |                 | 09-05-27  | LSan |  |                   |
| 60   |                 | 09-05-15  | LSan |  |                   |
| 58   |                 | 09-03-25  | LSan |  |                   |
| Rev. | Change Info     | Date      | Name |  |                   |

## Marking Specification for Brazilian Market

**Z23134-A0600**

Blatt  
36/47

This controlled document is subject to change

Sin nuestra expresa autorización, queda terminantemente prohibida la reproducción total o parcial de este documento, así como su uso indebido y/o su exhibición o comunicación a terceros. De los infractores se exigirá el correspondiente resarcimiento de daños y perjuicios. Se reserva todos los derechos para el caso de la con cesión de patente de invención o el registro de Modelo industrial

Weitergabe sowie Vervielfältigung dieser Unterlage, Verbreitung und Mitteilung ihres Inhaltes nicht gestattet, soweit nicht ausdrücklich zugestanden. Zuwiderhandlungen verpflichten zu Schadensersatz. Alle Rechte vorbehalten, insbesondere für den Fall der Patenterteilung oder GMA-Eintragung.

The reproduction, transmission or use of this document or its contents is not permitted without express written authority. Offenders will be liable for damages. All rights, including rights created by patent grant or registration of a utility model or design, are reserved.

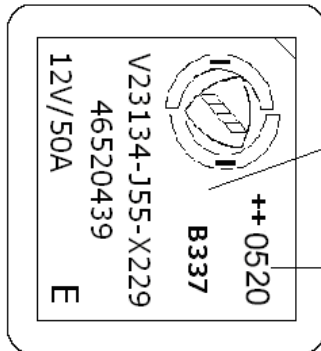
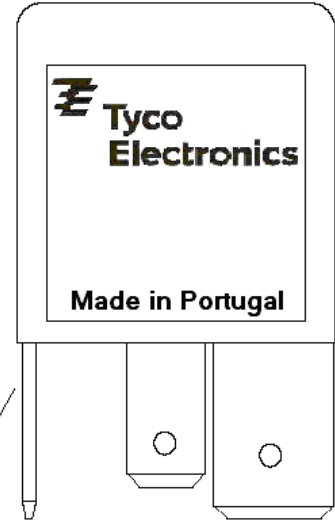
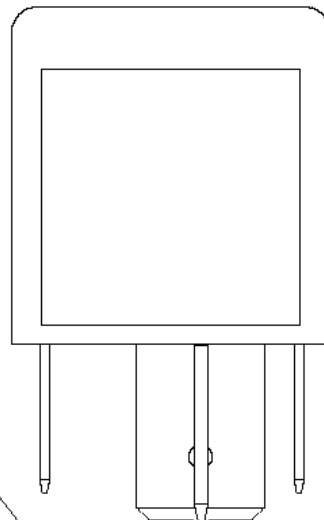
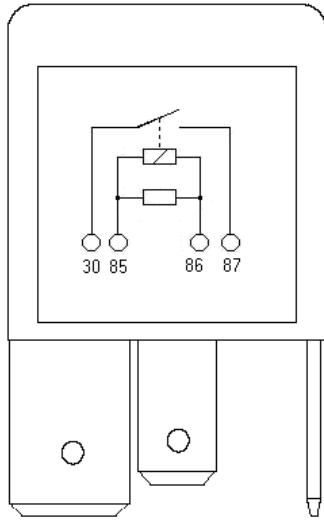
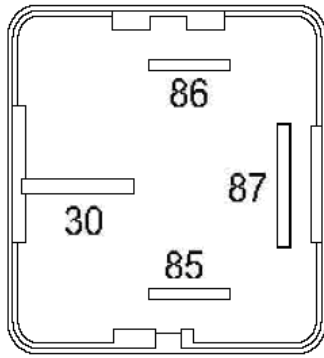

TAMPO PRINT  
White Colour

Injection moulded  
0.1 mm raised

|      |                 |           |      |  |                   |
|------|-----------------|-----------|------|--|-------------------|
| C1   | ---             | 10MAR2016 | LSan | Date   | 09-01-13          |
| C    | ---             | 22MAY2015 | LSan | Eng.   | Sandoval 09-01-12 |
| B    | ---             | 25FEB2014 | LSan | Check  |                   |
| A    | ---             | 06DEC2013 | LSan | Appr.  |                   |
| 62   | Initial Release | 09-06-10  | LSan | <b>PE EVORA</b><br> |                   |
| 61   |                 | 09-05-27  | LSan |  |                   |
| 60   |                 | 09-05-15  | LSan |  |                   |
| 58   |                 | 09-03-25  | LSan |  |                   |
| Rev. | Change Info     | Date      | Name |  |                   |

## Marking Specification for Brazilian Market

Z23134-A0600

Blatt  
37/47

This controlled document is subject to change

Sin nuestra expresa autorización, queda terminantemente prohibida la reproducción total o parcial de este documento, así como su uso indebido y/o su exhibición o comunicación a terceros. De los infractores se exigirá el correspondiente resarcimiento de daños y perjuicios. Se reserva todos los derechos para el caso de la con cesión de patente de invención o el registro de Modelo industrial

Weitergabe sowie Vervielfältigung dieser Unterlage, Verwertung und Mitteilung ihres Inhaltes nicht gestattet, soweit nicht ausdrücklich zugestanden. Zuwiderhandlungen verpflichten zu Schadenersatz. Alle Rechte vorbehalten, insbesondere für den Fall der Patenterteilung oder GMA-Eintragung.

The reproduction, transmission or use of this document or its contents is not permitted without express written authority. Offenders will be liable for damages. All rights, including rights created by patent grant or registration of a utility model or design, are reserved.

**3**  
TE LOGO  
according to TE specification 15989 -  
Lettering Size= Part Number 1-15989-1

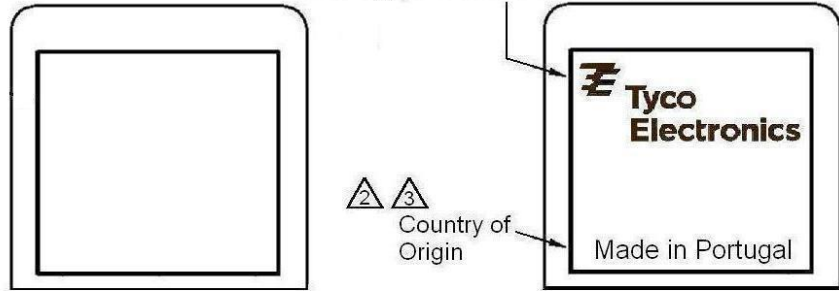

**2 3**  
Country of Origin  
Made in Portugal

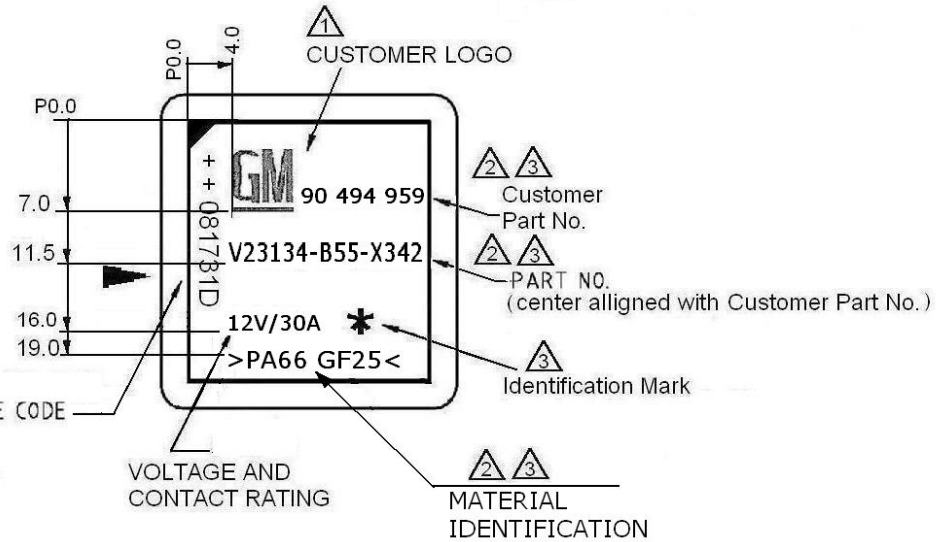

**2 4**  
MANUFACTURING DATE CODE  
E.X: ++081731D  
++ = PORTUGAL  
08 = Year  
17 = Week  
3 = Day  
1 = Shift  
D = Line

- 1** According to ON 1396.5 - Size 2
- 2** Lettering Size: Arial font, Height 2.0 ± 0,1mm
- 3** Stamped (gasoline proof), Marking colour WHITE for black cover and BLACK for other cover colours. or Injection moulded (0,1 mm raised)
- 4** Stamped (gasoline proof), Marking colour WHITE for black cover and BLACK for other cover colours.

Marking should not touch the edge of marking area

► Latching nose (cover)

**Remark: If ink printed, then lettering size 1,8 +0,1 for PART NO.**

Currently Situation: All Injection molded exception Star and Date code (Black).

|      |                 |           |      |                     |                   |
|------|-----------------|-----------|------|---------------------|-------------------|
| C1   | ---             | 10MAR2016 | LSan | Date                | 09-01-13          |
| C    | ---             | 22MAY2015 | LSan | Eng.                | Sandoval 09-01-12 |
| B    | ---             | 25FEB2014 | LSan | Check               |                   |
| A    | ---             | 06DEC2013 | LSan | Appr.               |                   |
| 62   | Initial Release | 09-06-10  | LSan | <b>PE EVORA</b><br> |                   |
| 61   |                 | 09-05-27  | LSan |                     |                   |
| 60   |                 | 09-05-15  | LSan |                     |                   |
| 58   |                 | 09-03-25  | LSan |                     |                   |
| Rev. | Change Info     | Date      | Name |                     |                   |

## Marking Specification for Brazilian Market

**Z23134-A0600**

Blatt  
38/47

This controlled document is subject to change

Sin nuestra expresa autorización, queda terminantemente prohibida la reproducción total o parcial de este documento, así como su uso indebido y/o su exhibición o comunicación a terceros. De los infractores se exigirá el correspondiente resarcimiento de daños y perjuicios. Se reserva todos los derechos para el caso de la con cesión de patente de invención o el registro de Modelo industrial

Weitergabe sowie Vervielfältigung dieser Unterlage, Verwertung und Mitteilung ihres Inhaltes nicht gestattet, soweit nicht ausdrücklich zugestanden. Zuwiderhandlungen verpflichten zu Schadensersatz. Alle Rechte vorbehalten, insbesondere für den Fall der Patenterteilung oder GMA-Eintragung.

The reproduction, transmission or use of this document or its contents is not permitted without express written authority. Offenders will be liable for damages. All rights, including rights created by patent grant or registration of a utility model or design, are reserved.

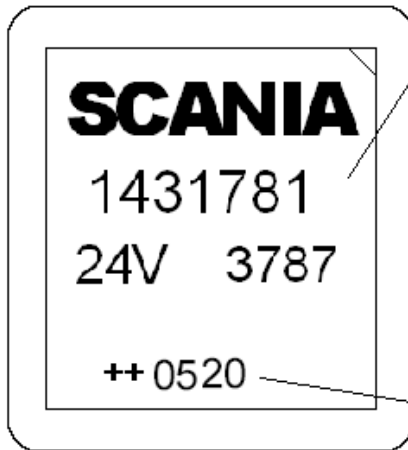
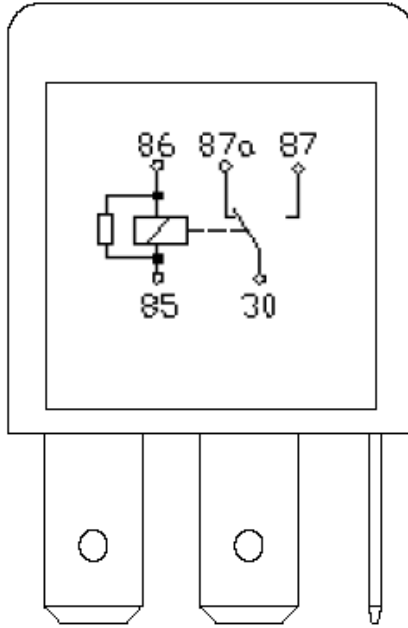
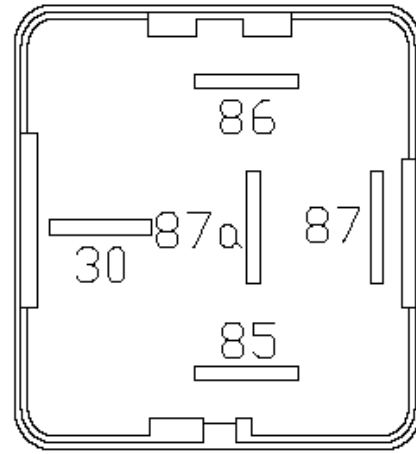

Injection moulded  
0,1 mm raised

TAMPO PRINT  
White Colour

|      |                 |           |      |  |                   |
|------|-----------------|-----------|------|--|-------------------|
| C1   | ---             | 10MAR2016 | LSan | Date   | 09-01-13          |
| C    | ---             | 22MAY2015 | LSan | Eng.   | Sandoval 09-01-12 |
| B    | ---             | 25FEB2014 | LSan | Check  |                   |
| A    | ---             | 06DEC2013 | LSan | Appr.  |                   |
| 62   | Initial Release | 09-06-10  | LSan | <b>PE EVORA</b><br> |                   |
| 61   |                 | 09-05-27  | LSan |  |                   |
| 60   |                 | 09-05-15  | LSan |  |                   |
| 58   |                 | 09-03-25  | LSan |  |                   |
| Rev. | Change Info     | Date      | Name |  |                   |

## Marking Specification for Brazilian Market

Z23134-A0600

Blatt  
39/47

This controlled document is subject to change

Sin nuestra expresa autorización, queda terminantemente prohibida la reproducción total o parcial de este documento, así como su uso indebido y/o su exhibición o comunicación a terceros. De los infractores se exigirá el correspondiente resarcimiento de daños y perjuicios. Se reserva todos los derechos para el caso de la con cesión de patente de invención o el registro de Modelo industrial

Weitergabe sowie Vervielfältigung dieser Unterlage, Wertung und Mitteilung ihres Inhaltes nicht gestattet, soweit nicht ausdrücklich zugestanden. Zuwiderhandlungen verpflichten zu Schadensersatz. Alle Rechte vorbehalten, insbesondere für den Fall der Patenterteilung oder GMA-Eintragung.

The reproduction, transmission or use of this document or its contents is not permitted without express written authority. Offenders will be liable for damages. All rights, including rights created by patent grant or registration of a utility model or design, are reserved.

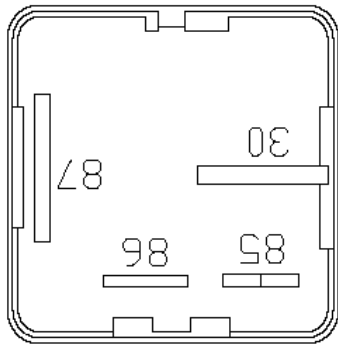

Injection moulded  
0,1 mm raised

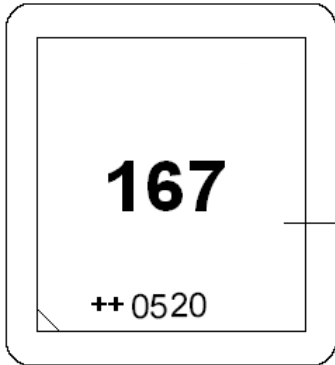
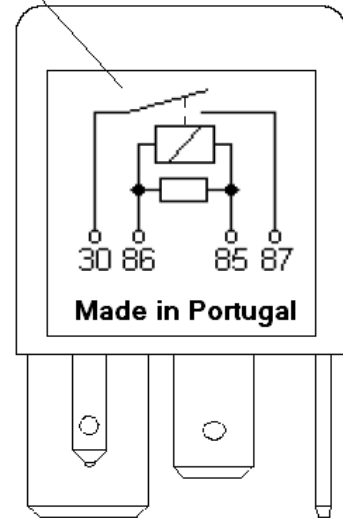
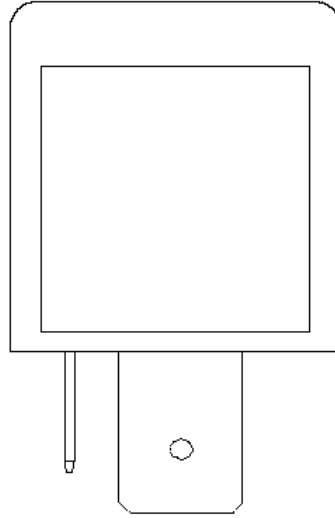
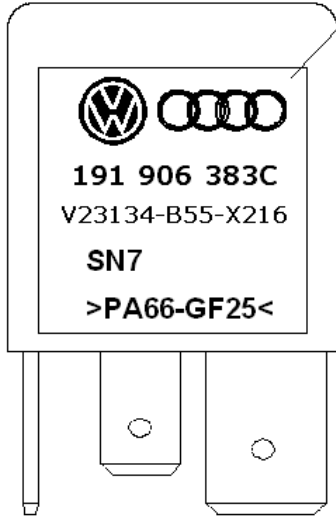

TAMPO PRINT  
Black Colour

Remark: For more information to see marking specification Z23134-A0063

|      |                 |           |      |  |                   |
|------|-----------------|-----------|------|--|-------------------|
| C1   | ---             | 10MAR2016 | LSan | Date   | 09-01-13          |
| C    | ---             | 22MAY2015 | LSan | Eng.   | Sandoval 09-01-12 |
| B    | ---             | 25FEB2014 | LSan | Check  |                   |
| A    | ---             | 06DEC2013 | LSan | Appr.  |                   |
| 62   | Initial Release | 09-06-10  | LSan | <b>PE EVORA</b><br> |                   |
| 61   |                 | 09-05-27  | LSan |  |                   |
| 60   |                 | 09-05-15  | LSan |  |                   |
| 58   |                 | 09-03-25  | LSan |  |                   |
| Rev. | Change Info     | Date      | Name |  |                   |

## Marking Specification for Brazilian Market

Z23134-A0600

Blatt  
40/47

This controlled document is subject to change

Sin nuestra expresa autorización, queda terminantemente prohibida la reproducción, total o parcial de este documento, así como su uso indebido y/o su exhibición o comunicación a terceros. De los infractores se exigirá el correspondiente resarcimiento de daños y perjuicios. Se reserva todos los derechos para el caso de la con cesión de patente de invención o el registro de Modelo industrial

Weitergabe sowie Vervielfältigung dieser Unterlage, Verwertung und Mitteilung ihres Inhaltes nicht gestattet, soweit nicht ausdrücklich zugestanden. Zuwiderhandlungen verpflichten zu Schadensersatz. Alle Rechte vorbehalten, insbesondere für den Fall der Patenterteilung oder GMA-Eintragung.

The reproduction, transmission or use of this document or its contents is not permitted without express written authority. Offenders will be liable for damages. All rights, including rights created by patent grant or registration of a utility model or design, are reserved.

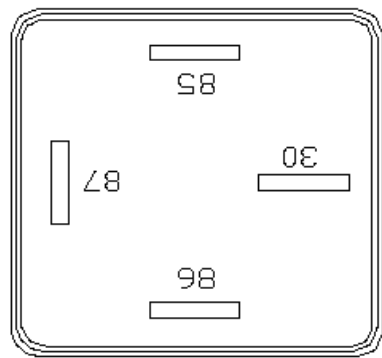

Injection moulded  
0.1 mm raised

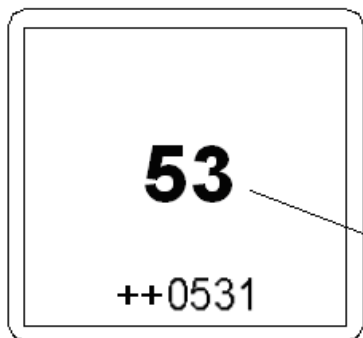
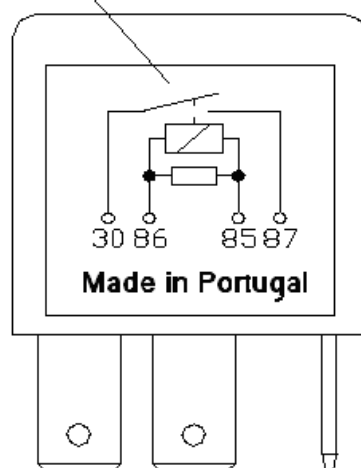
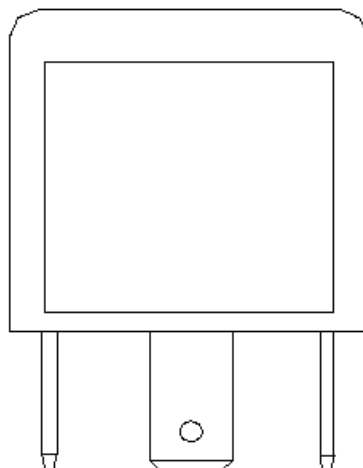
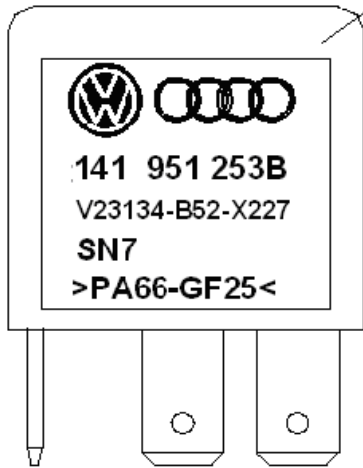

TAMPO PRINT  
Black colour

Remark: For more information to see marking specification Z23134-A0063

|      |                 |           |      |  |                   |
|------|-----------------|-----------|------|--|-------------------|
| C1   | ---             | 10MAR2016 | LSan | Date   | 09-01-13          |
| C    | ---             | 22MAY2015 | LSan | Eng.   | Sandoval 09-01-12 |
| B    | ---             | 25FEB2014 | LSan | Check  |                   |
| A    | ---             | 06DEC2013 | LSan | Appr.  |                   |
| 62   | Initial Release | 09-06-10  | LSan | <b>PE EVORA</b><br> |                   |
| 61   |                 | 09-05-27  | LSan |  |                   |
| 60   |                 | 09-05-15  | LSan |  |                   |
| 58   |                 | 09-03-25  | LSan |  |                   |
| Rev. | Change Info     | Date      | Name |  |                   |

## Marking Specification for Brazilian Market

Z23134-A0600

Blatt  
41/47

This controlled document is subject to change

Sin nuestra expresa autorización, queda terminantemente prohibida la reproducción total o parcial de este documento, así como su uso indebido y/o su exhibición o comunicación a terceros. De los infractores se exigirá el correspondiente resarcimiento de daños y perjuicios. Se reserva todos los derechos para el caso de la con cesión de patente de invención o el registro de Modelo industrial

Weitergabe sowie Vervielfältigung dieser Unterlage, Verwertung und Mitteilung ihres Inhaltes nicht gestattet, soweit nicht ausdrücklich zugestanden. Zuwiderhandlungen verpflichten zu Schadensersatz. Alle Rechte vorbehalten, insbesondere für den Fall der Patenterteilung oder GMA-Eintragung.

The reproduction, transmission or use of this document or its contents is not permitted without express written authority. Offenders will be liable for damages. All rights, including rights created by patent grant or registration of a utility model or design, are reserved.

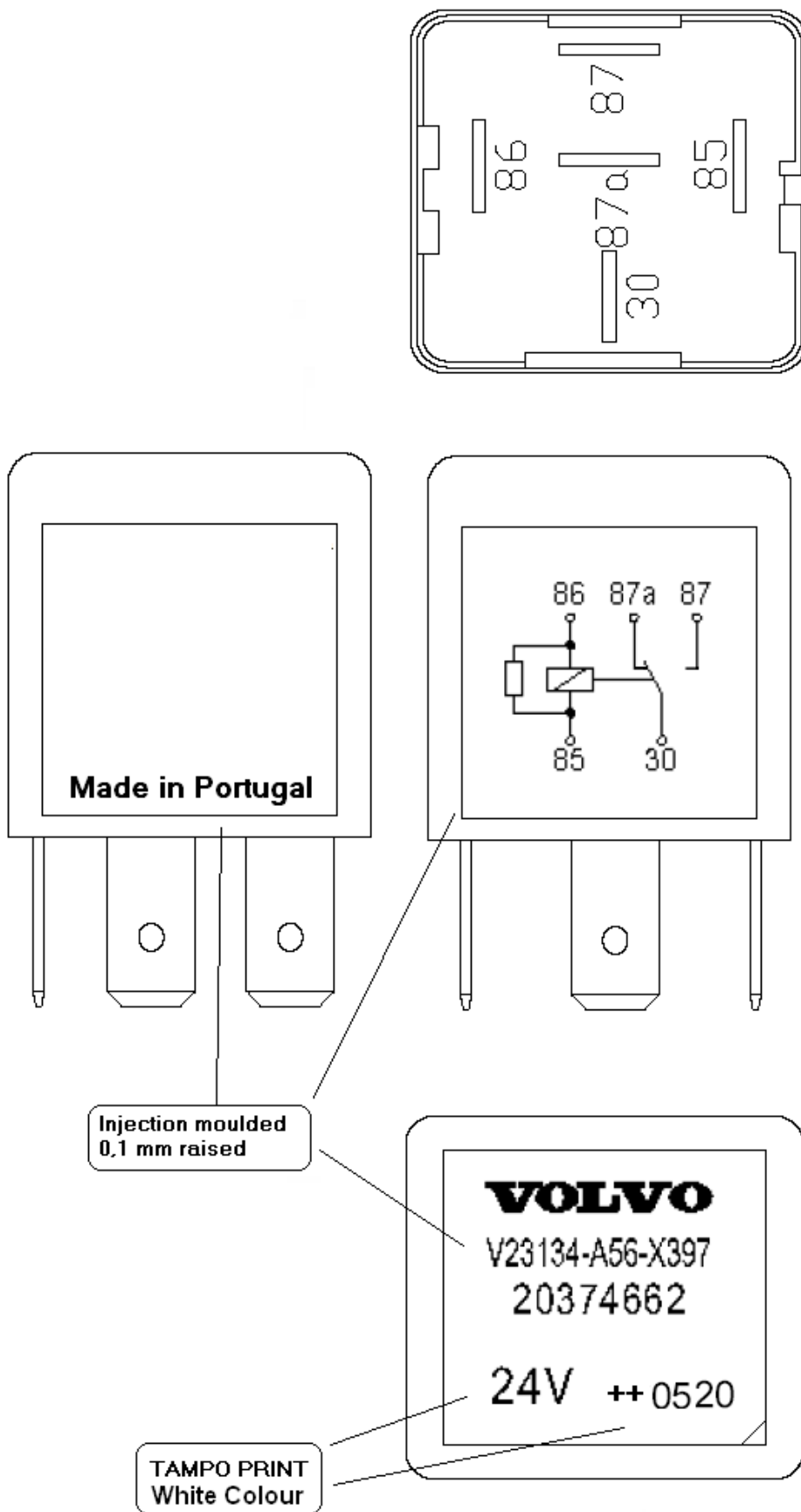

|      |                 |           |      |  |                   |
|------|-----------------|-----------|------|--|-------------------|
| C1   | ---             | 10MAR2016 | LSan | Date   | 09-01-13          |
| C    | ---             | 22MAY2015 | LSan | Eng.   | Sandoval 09-01-12 |
| B    | ---             | 25FEB2014 | LSan | Check  |                   |
| A    | ---             | 06DEC2013 | LSan | Appr.  |                   |
| 62   | Initial Release | 09-06-10  | LSan | <b>PE EVORA</b><br> |                   |
| 61   |                 | 09-05-27  | LSan |  |                   |
| 60   |                 | 09-05-15  | LSan |  |                   |
| 58   |                 | 09-03-25  | LSan |  |                   |
| Rev. | Change Info     | Date      | Name |  |                   |

**Marking Specification for Brazilian Market**

**Z23134-A0600**

Blatt 42/47

This controlled document is subject to change

Sin nuestra expresa autorización, queda terminantemente prohibida la reproducción total o parcial de este documento, así como su uso indebido y/o su exhibición o comunicación a terceros. De los infractores se exigirá el correspondiente resarcimiento de daños y perjuicios. Se reserva todos los derechos para el caso de la concesión de patente de invención o el registro de Modelo industrial.

Weitergabe sowie Vervielfältigung dieser Unterlage, Verwertung und Mitteilung ihres Inhaltes nicht gestattet, soweit nicht ausdrücklich zugestanden. Zuwiderhandlungen verpflichten zu Schadensersatz. Alle Rechte vorbehalten, insbesondere für den Fall der Patenterteilung oder GMA-Eintragung.

The reproduction, transmission or use of this document or its contents is not permitted without express written authority. Offenders will be liable for damages. All rights, including rights created by patent grant or registration of a utility model or design, are reserved.

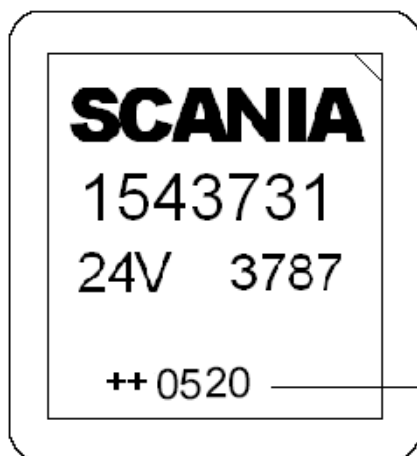
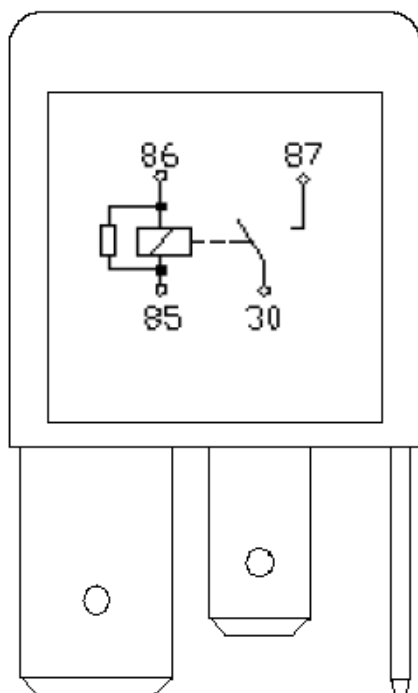
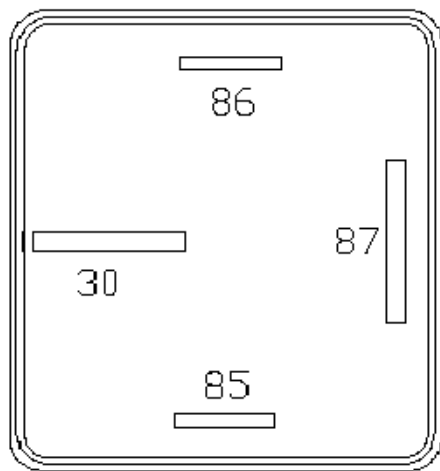

Injection moulded  
0,1 mm raised

TAMPO PRINT  
White Colour

|      |                 |           |      |  |                   |
|------|-----------------|-----------|------|--|-------------------|
| C1   | ---             | 10MAR2016 | LSan | Date   | 09-01-13          |
| C    | ---             | 22MAY2015 | LSan | Eng.   | Sandoval 09-01-12 |
| B    | ---             | 25FEB2014 | LSan | Check  |                   |
| A    | ---             | 06DEC2013 | LSan | Appr.  |                   |
| 62   | Initial Release | 09-06-10  | LSan | <b>PE EVORA</b><br> |                   |
| 61   |                 | 09-05-27  | LSan |  |                   |
| 60   |                 | 09-05-15  | LSan |  |                   |
| 58   |                 | 09-03-25  | LSan |  |                   |
| Rev. | Change Info     | Date      | Name |  |                   |

## Marking Specification for Brazilian Market

Z23134-A0600

Blatt  
43/47

This controlled document is subject to change

Sin nuestra expresa autorización, queda terminantemente prohibida la reproducción total o parcial de este documento, así como su uso indebido y/o su exhibición o comunicación a terceros. De los infractores se exigirá el correspondiente resarcimiento de daños y perjuicios. Se reserva todos los derechos para el caso de la con cesión de patente de invención o el registro de Modelo industrial

Weitergabe sowie Vervielfältigung dieser Unterlage, Verwertung und Mitteilung ihres Inhaltes nicht gestattet, soweit nicht ausdrücklich zugestanden. Zuwiderhandlungen verpflichten zu Schadensersatz. Alle Rechte vorbehalten, insbesondere für den Fall der Patenterteilung oder GMA-Eintragung.

The reproduction, transmission or use of this document or its contents is not permitted without express written authority. Offenders will be liable for damages. All rights, including rights created by patent grant or registration of a utility model or design, are reserved.

<sup>3</sup> TE LOGO  
according to TE specification 15989 -  
Lettering Size= Part Number 1-15989-1

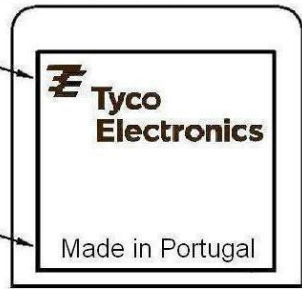
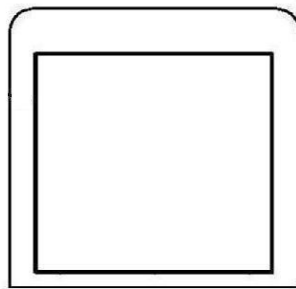

<sup>2</sup> <sup>3</sup> Country of Origin

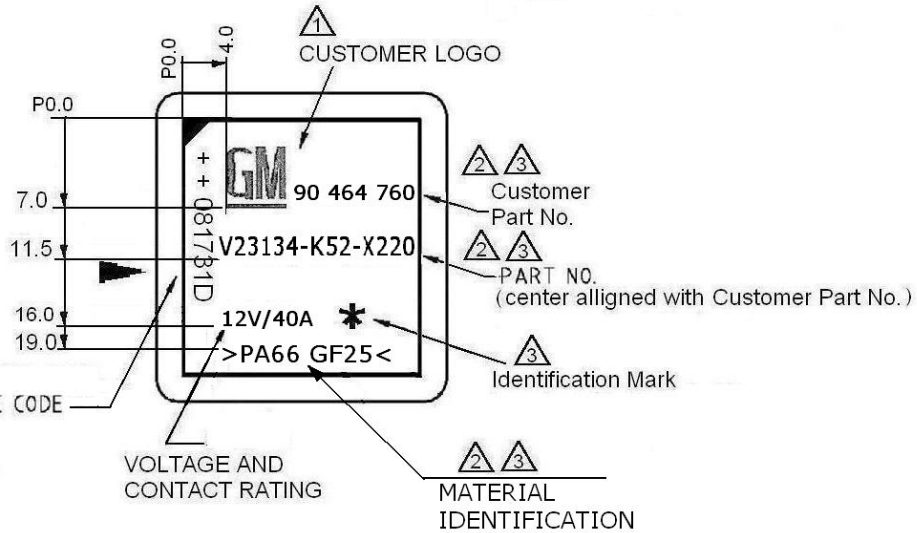

<sup>2</sup> <sup>4</sup> MANUFACTURING DATE CODE

E.X: ++081731D  
++ = PORTUGAL  
08 = Year  
17 = Week  
3 = Day  
1 = Shift  
D = Line

- <sup>1</sup> According to ON 1396.5 - Size 2
- <sup>2</sup> Lettering Size: Arial font, Height 2.0 ± 0,1mm
- <sup>3</sup> Stamped (gasoline proof), Marking colour WHITE for black cover and BLACK for other cover colours. or Injection moulded (0,1 mm raised)
- <sup>4</sup> Stamped (gasoline proof), Marking colour WHITE for black cover and BLACK for other cover colours.

Marking should not touch the edge of marking area

► Latching nose (cover)

**Remark: If ink printed, then lettering size 1,8 +0,1 for PART NO.**

Currently Situation: Tyco Logo and Made in Portugal injection molded, Relay specifications and Star (White) and Date code (Yellow) printed.

|      |                 |           |      |                     |                   |
|------|-----------------|-----------|------|---------------------|-------------------|
| C1   | ---             | 10MAR2016 | LSan | Date                | 09-01-13          |
| C    | ---             | 22MAY2015 | LSan | Eng.                | Sandoval 09-01-12 |
| B    | ---             | 25FEB2014 | LSan | Check               |                   |
| A    | ---             | 06DEC2013 | LSan | Appr.               |                   |
| 62   | Initial Release | 09-06-10  | LSan | <b>PE EVORA</b><br> |                   |
| 61   |                 | 09-05-27  | LSan |                     |                   |
| 60   |                 | 09-05-15  | LSan |                     |                   |
| 58   |                 | 09-03-25  | LSan |                     |                   |
| Rev. | Change Info     | Date      | Name |                     |                   |

## Marking Specification for Brazilian Market

Z23134-A0600

Blatt 44/47

This controlled document is subject to change

Sin nuestra expresa autorización, queda terminantemente prohibida la reproducción total o parcial de este documento, así como su uso indebido y/o su exhibición o comunicación a terceros. De los infractores se exigirá el correspondiente resarcimiento de daños y perjuicios. Se reserva todos los derechos para el caso de la concesión de patente de invención o el registro de Modelo industrial

Weitergabe sowie Vervielfältigung dieser Unterlage, Verwertung und Mitteilung ihres Inhaltes nicht gestattet, soweit nicht ausdrücklich zugestanden. Zuwiderhandlungen verpflichten zu Schadenersatz. Alle Rechte vorbehalten, insbesondere für den Fall der Patenterteilung oder GMA-Eintragung.

The reproduction, transmission or use of this document or its contents is not permitted without express written authority. Offenders will be liable for damages. All rights, including rights created by patent grant or registration of a utility model or design, are reserved.

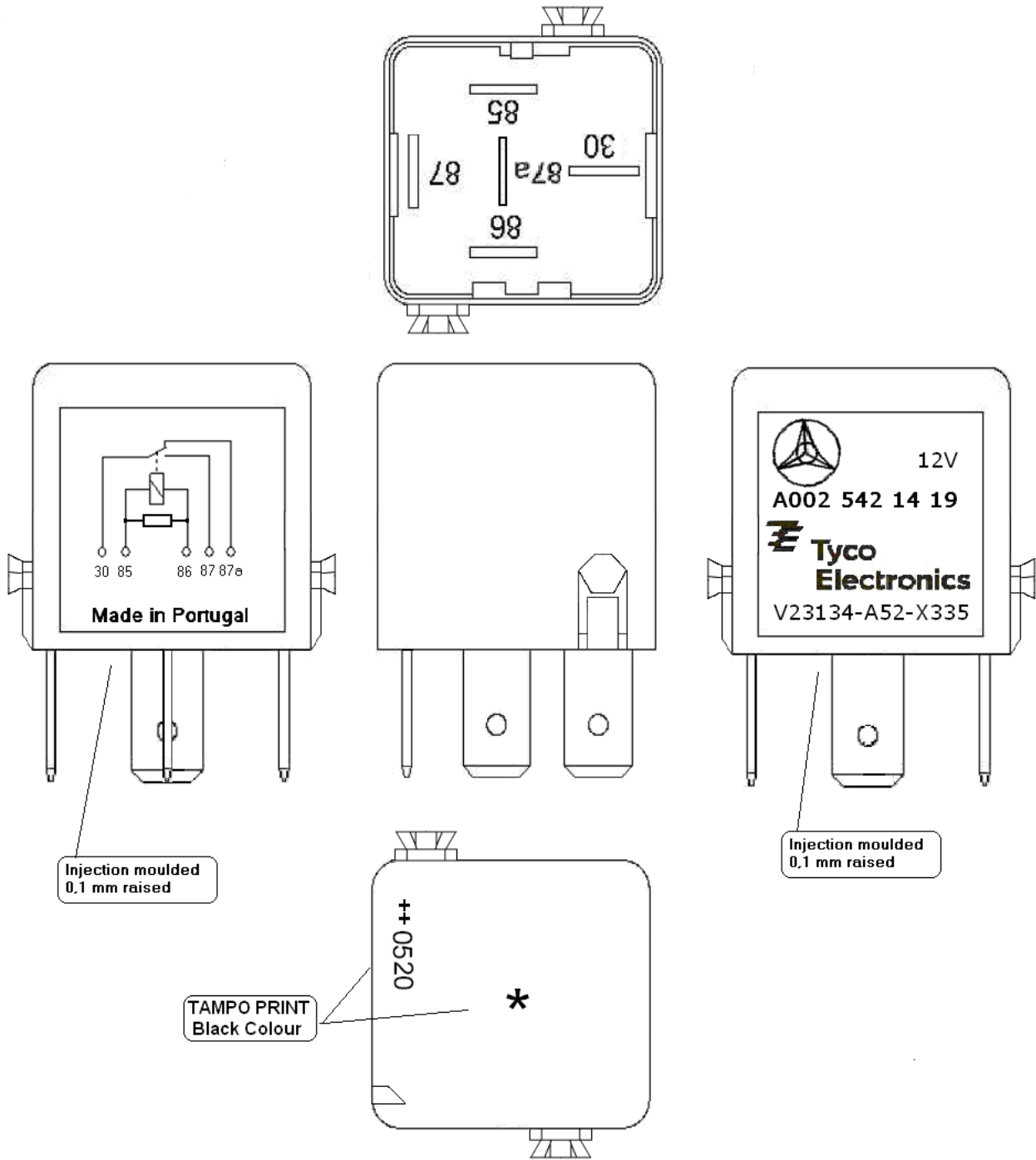

|      |                 |           |      |  |                   |
|------|-----------------|-----------|------|--|-------------------|
| C1   | ---             | 10MAR2016 | LSan | Date   | 09-01-13          |
| C    | ---             | 22MAY2015 | LSan | Eng.   | Sandoval 09-01-12 |
| B    | ---             | 25FEB2014 | LSan | Check  |                   |
| A    | ---             | 06DEC2013 | LSan | Appr.  |                   |
| 62   | Initial Release | 09-06-10  | LSan | <b>PE EVORA</b><br> |                   |
| 61   |                 | 09-05-27  | LSan |  |                   |
| 60   |                 | 09-05-15  | LSan |  |                   |
| 58   |                 | 09-03-25  | LSan |  |                   |
| Rev. | Change Info     | Date      | Name |  |                   |

## Marking Specification for Brazilian Market

Z23134-A0600

Blatt  
45/47

This controlled document is subject to change

Sin nuestra expresa autorización, queda terminantemente prohibida la reproducción, total o parcial de este documento, así como su uso indebido y/o su exhibición o comunicación a terceros. De los infractores se exigirá el correspondiente resarcimiento de daños y perjuicios. Se reserva todos los derechos para el caso de la con cesión de patente de invención o el registro de Modelo industrial

Weitergabe sowie Vervielfältigung dieser Unterlage, Verwertung und Mitteilung ihres Inhaltes nicht gestattet, soweit nicht ausdrücklich zugestanden. Zuwiderhandlungen verpflichten zu Schadensersatz. Alle Rechte vorbehalten, insbesondere für den Fall der Patenterteilung oder GMA-Eintragung.

The reproduction, transmission or use of this document or its contents is not permitted without express written authority. Offenders will be liable for damages. All rights, including rights created by patent grant or registration of a utility model or design, are reserved.

## V23134-B0053-X608 (V23134B53Y031P)

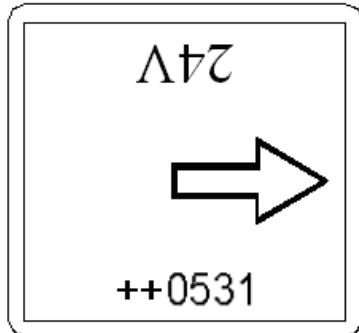
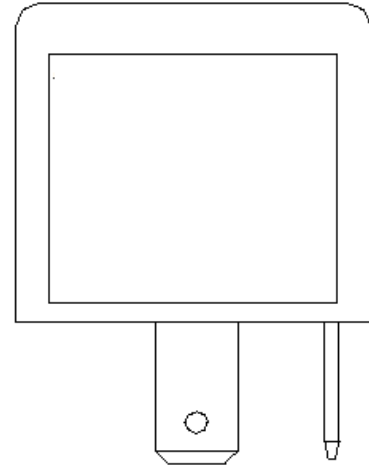
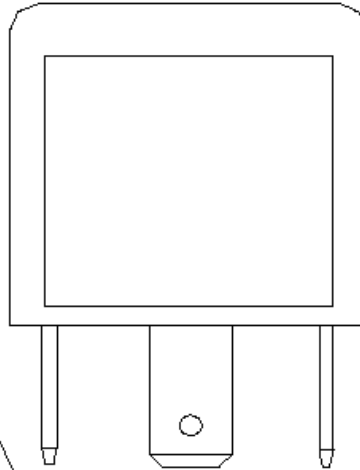
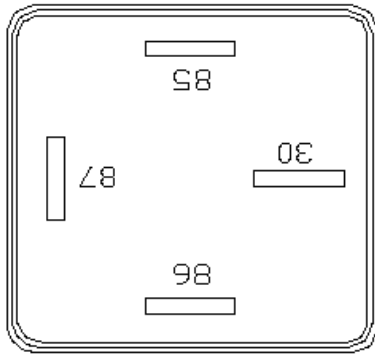

TAMPO PRINT  
White Colour

Remark: For more information to see marking specification Z23134-A0063

### Marking Specification for Brazilian Market

|      |                 |           |      |  |                   |
|------|-----------------|-----------|------|--|-------------------|
| C1   | ---             | 10MAR2016 | LSan | Date   | 09-01-13          |
| C    | ---             | 22MAY2015 | LSan | Eng.   | Sandoval 09-01-12 |
| B    | ---             | 25FEB2014 | LSan | Check  |                   |
| A    | ---             | 06DEC2013 | LSan | Appr.  |                   |
| 62   | Initial Release | 09-06-10  | LSan | <b>PE EVORA</b><br> |                   |
| 61   |                 | 09-05-27  | LSan |  |                   |
| 60   |                 | 09-05-15  | LSan |  |                   |
| 58   |                 | 09-03-25  | LSan |  |                   |
| Rev. | Change Info     | Date      | Name |  |                   |

Z23134-A0600

Blatt  
46/47

This controlled document is subject to change

Sin nuestra expresa autorización, queda terminantemente prohibida la reproducción total o parcial de este documento, así como su uso indebido y/o su exhibición o comunicación a terceros. De los infractores se exigirá el correspondiente resarcimiento de daños y perjuicios. Se reserva todos los derechos para el caso de la con cesión de patente de invención o el registro de Modelo industrial

Weitergabe sowie Vervielfältigung dieser Unterlage, Wertung und Mitteilung ihres Inhaltes nicht gestattet, soweit nicht ausdrücklich zugestanden. Zuwiderhandlungen verpflichten zu Schadensersatz. Alle Rechte vorbehalten, insbesondere für den Fall der Patenterteilung oder GMA-Eintragung.

The reproduction, transmission or use of this document or its contents is not permitted without express written authority. Offenders will be liable for damages. All rights, including rights created by patent grant or registration of a utility model or design, are reserved.

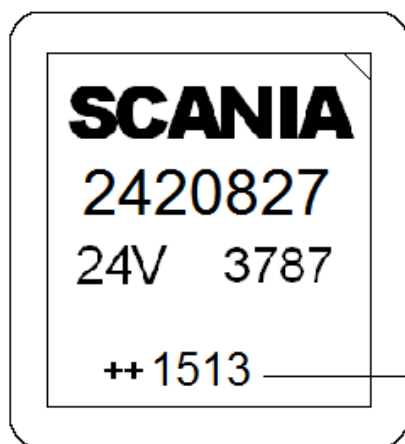
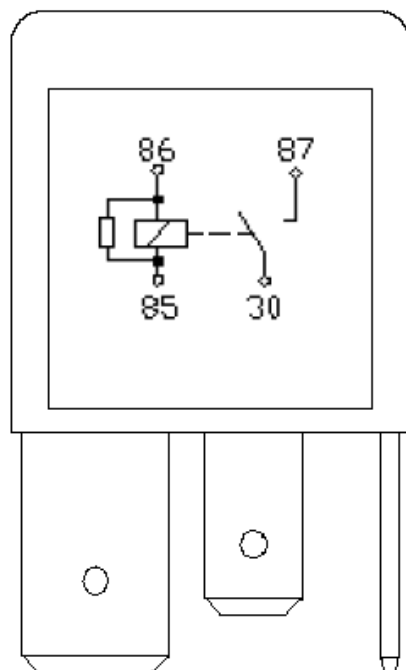
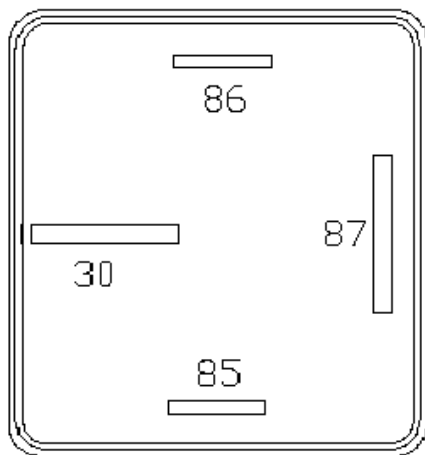

Injection moulded  
0,1 mm raised

TAMPO PRINT

|      |                 |           |      |  |                   |
|------|-----------------|-----------|------|--|-------------------|
| C1   | ---             | 10MAR2016 | LSan | Date   | 09-01-13          |
| C    | ---             | 22MAY2015 | LSan | Eng.   | Sandoval 09-01-12 |
| B    | ---             | 25FEB2014 | LSan | Check  |                   |
| A    | ---             | 06DEC2013 | LSan | Appr.  |                   |
| 62   | Initial Release | 09-06-10  | LSan | <b>PE EVORA</b><br> |                   |
| 61   |                 | 09-05-27  | LSan |  |                   |
| 60   |                 | 09-05-15  | LSan |  |                   |
| 58   |                 | 09-03-25  | LSan |  |                   |
| Rev. | Change Info     | Date      | Name |  |                   |

## Marking Specification for Brazilian Market

Z23134-A0600

Blatt  
47/47

This controlled document is subject to change