

REVISION FD

NOTES:

1. ⊗ REPRESENTS A CRITICAL DIMENSION.
2. PARTS MAY BE CUT TO POSITION.
3. MAXIMUM CUT FLASH: .015[0.38]. LOOSE FLASH MUST BE REMOVED.
4. MINIMUM PUSHOUT FORCE: 1.0 LB.
5. MEASURED AT BEND RADIUS, NOT AT END OF PIN.
6. TUBE ONLY -04 THROUGH -50 POSITIONS (SEE TABLE 2).
7. SHEAR TAILS TO DIMENSION SHOWN.
8. MAXIMUM BURR ALLOWANCE: .003 [0.08]
9. GOLD PLATING TO BE ON POST, TIN PLATING TO BE ON TAIL.
10. FILL WITH ALIGNMENT PIN HOLES TO TAIL SIDE.
11. DUE TO THE HIGH AMOUNT OF INSERTION FORCE NEEDED, LOCKING CLIPS ARE NOT COMPATIBLE WITH AUTO PLACEMENT. SAMTEC RECOMMENDS MANUAL PLACEMENT FOR ALL ASSEMBLIES WITH LOCKING CLIPS.
12. VOIDS MAY OR MAY NOT BE PRESENT ON POSITIONS 5 THRU 8 AND CAN BE MIXED WITHIN AN ORDER.
13. ON LEAD STYLES -02 THROUGH -03 THE T-1S15-18-XXX CAN BE SUBSTITUTED FOR T-1S15-16-XXX.
14. ON LEAD STYLES -01 AND -04, T-1S15-17 CAN BE SUBSTITUTED FOR T-1S15-15-XXX.
15. NO TIN PLATING ALLOWED ON THE POST FOR LEAD STYLES -01, -02, -03 & -04.

FTSH-1XX-XX-XXX-DV-XXX-XXX

No OF POSITIONS

-02 THRU -50
(PER ROW)

LEAD STYLE

- 01: .120 [3.05]
- 02: .075 [1.91]
- 03: .065 [1.65]
- 04: .150 [3.81]
- 05: .170 [4.32]
- 14: .150 [3.81] [NOT AVAILABLE WITH -SM, FM, LM PLATING OPTIONS]

PLATING SPECIFICATION

- L: 10 μ " SELECTIVE GOLD IN CONTACT AREA, MATTE TIN ON TAIL
- F: 3 μ " SELECTIVE GOLD IN CONTACT AREA, MATTE TIN ON TAIL
- S: 30 μ " SELECTIVE GOLD IN CONTACT AREA, MATTE TIN ON TAIL
- H: 30 μ " GOLD IN CONTACT AREA, 3 μ " GOLD ON TAIL
- LM: 10 μ " SELECTIVE GOLD IN CONTACT AREA, MATTE TIN ON TAIL
- FM: 3 μ " SELECTIVE GOLD IN CONTACT AREA, MATTE TIN ON TAIL
- SM: 30 μ " SELECTIVE GOLD IN CONTACT AREA, MATTE TIN ON TAIL
- LTL: 10 μ " SELECTIVE GOLD IN CONTACT AREA, TIN/LEAD (90/10+/-5%) TAIL
- G: 10 μ " GOLD IN CONTACT AREA, 3 μ " GOLD ON TAIL

TAIL OPTION

-DV: DOUBLE VERTICAL

OPTIONS

- P: PICK & PLACE PAD (4 POS MIN) (SEE FIG 11, SHT 4 & TABLE 5)
- TR: TAPE & REEL PACKAGING
- ES: END SHROUDS (SEE FIG 6, SHT 3) (MOLDED IN 5 POS MIN; -02 & -03 LEAD STYLE ONLY) (SNAP SHROUDS 9 POS MIN; -02 & -03 LEAD STYLE ONLY) (MUST USE FTSH-50-D)
- EJ: EJECTOR SHROUDS: SEE FIG 4, SHT 2) (10 POS MIN; -01 LEAD STYLE ONLY) (MUST USE FTSH-50-D)
- EJM: EJECTOR SHROUDS WITH MOLDED ALIGNMENT PIN (SEE FIG 5, SHT 2; 10 POS MIN; -01 LEAD STYLE ONLY) (NOT VALID WITH -A OPTION) (MUST USE FTSH-50-D)
- EJC: EJECTOR SHROUDS WITH LOCKING CLIP (SEE FIG 5, SHT 2 & NOTE 11) (10 POS MIN; -01 LEAD STYLE ONLY; NOT VALID WITH -A OPTION) (MUST USE FTSH-50-D)
- EC: LOCKING CLIP (SEE FIG 7, SHT 3 & NOTE 11) (9 POS MIN; -02 & -03 LEAD STYLE ONLY) (MUST USE FTSH-50-D)
- EP: GUIDE POST (SEE FIG 8, SHT 3; 9 POS MIN; -02 & -03 LEAD STYLE ONLY) (USE ONLY WHEN MATING WITH CLP) (MUST USE FTSH-50-D)
- EL: BOARD LOCK (SEE FIG 9, SHT 3) (9 POS MIN; -02 & -03 LEAD STYLE ONLY) (USE ONLY WHEN MATING WITH CLP) (MUST USE FTSH-50-D)
- EPC: GUIDE POST & LOCKING CLIP (SEE FIG 10, SHT 3 & NOTE 11; USE ONLY WHEN MATING WITH CLP) (9 POS MIN; -02 & -03 LEAD STYLE ONLY; NOT VALID WITH -A OPTION) (MUST USE FTSH-50-D)
- A: ALIGNMENT PIN (MOLDED OR STAKED; SEE FIG 3, SHT 2) (MOLDED: 3 POS MIN; STAKED: 6 POS MIN) (SAMTEC DISCRETION ON WHICH -A PIN USED) (MUST USE FTSH-50-D)
- K: KEYING OPTION FOR MATING WITH FFS (SEE TABLE 3, SHT 2; 05 THRU 25 AVAILABLE AS STANDARD) (POSITION 13, 17, 20 & 25 AVAILABLE WITH -EJ OPTION) (LEAD STYLE -01 ONLY, SEE FIG 2, SHT 2 & NOTE 12) (ALIGNMENT PIN AVAILABLE WITH -K OPTION BUT MUST BE MOLDED) (MUST USE FTSH-50-CN-XX-X OR FTSH-50-CN-XX-X)
- *-M: METAL PICK & PLACE PAD (5 POS MIN; USE MPP-22-5) (SEE FIG 12, SHT 4; NOT AVAILABLE WITH -K OPTION)

POLARIZING OPTION

XXX INDICATES POSITION TO BE OMITTED (NOT AVAILABLE WITH EXX OPTIONS) (ONLY AVAILABLE WITH -F, -FM, -L, -LM PLATING OPTIONS)

* = NOT ENGINEERING APPROVED

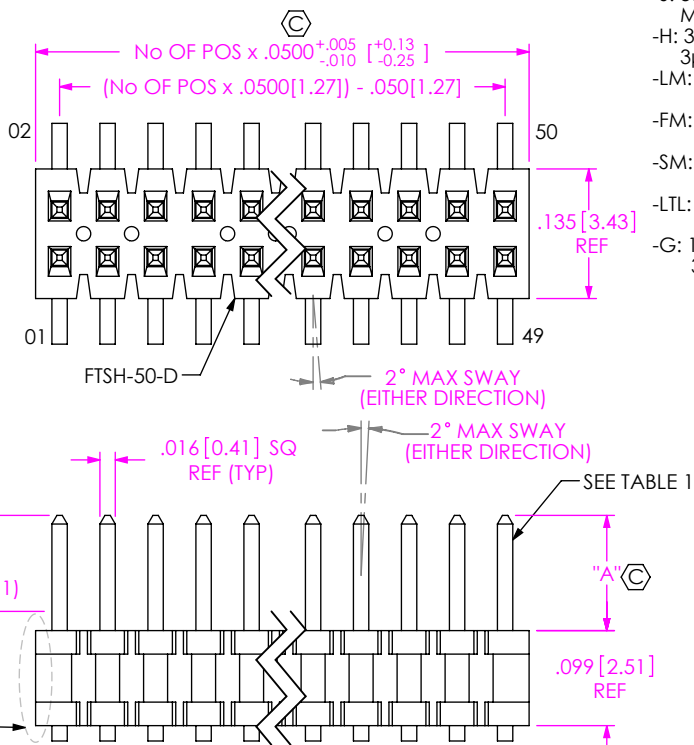
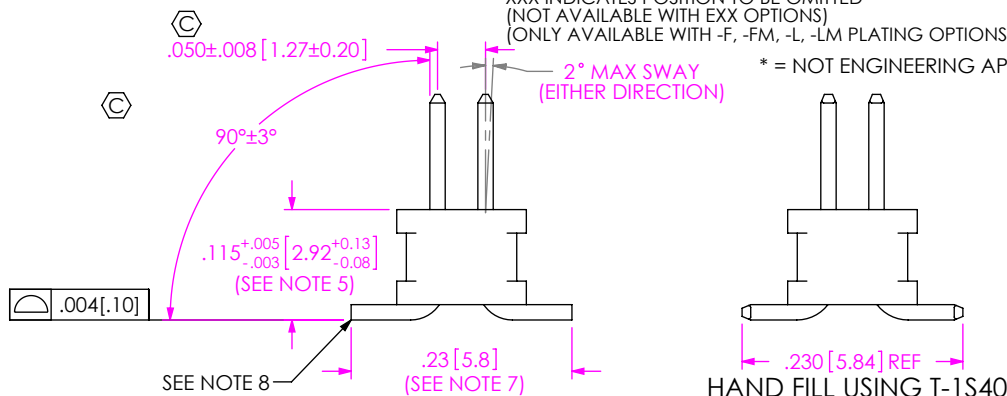

FIG 1
FTSH-1XX-XX-XXX-DV SHOWN



HAND FILL USING T-1S40

PATENT NUMBERS
5713755 / 5961339

TABLE 1							
LEAD STYLE	"A"	"B" REF	AUTOMATED BKT	"C" (OAL)	HAND FILL	"C" (OAL)	MICRO HEADER
-01	.120 [3.05]	.070 [1.78]	*** T-1S15-15-XXX	.675 [17.15]	T-1S40-03-XX-2	.309 [7.85]	T-1S40-03-XX-3
-02	.075 [1.91]	.050 [1.27]	* T-1S15-16-XXX	.675 [17.15]	* T-1S15-18-XXX	.800 [20.32]	NOT AVAILABLE
-03	.065 [1.65]	.050 [1.27]	** T-1S15-16-XXX	.675 [17.15]	* T-1S15-18-XXX	.800 [20.32]	NOT AVAILABLE
-04	.150 [3.81]	.070 [1.78]	*** T-1S15-15-XXX	.675 [17.15]	*** T-1S15-17-XXX	.800 [20.32]	NOT AVAILABLE
-05	.170 [4.32]	.070 [1.78]	T-1S15-03-XXX	.800 [20.32]	T-1S15-03-XXX	.800 [20.32]	NOT AVAILABLE
-14	.150 [3.81]	.135 [3.43]	T-1S15-63-XXX	.800 [20.32]	T-1S15-63-XXX	.800 [20.32]	NOT AVAILABLE

* = SEE NOTE 13
*** = SEE NOTE 14

UNLESS OTHERWISE SPECIFIED, DIMENSIONS ARE IN INCHES. TOLERANCES ARE:
DECIMALS ANGLES
.XX: ±.01 [.3] 1°
.XXX: ±.005 [.13]
.XXXX: ±.0010 [.025]

PROPRIETARY NOTE
THIS DOCUMENT CONTAINS CONFIDENTIAL AND PROPRIETARY INFORMATION AND ALL DESIGN, MANUFACTURING, REPRODUCTION, USE, PATENT RIGHTS AND SALES RIGHTS ARE EXPRESSLY RESERVED BY SAMTEC, INC. THIS DOCUMENT SHALL NOT BE DISCLOSED, IN WHOLE OR PART, TO ANY UNAUTHORIZED PERSON OR ENTITY NOR REPRODUCED, TRANSFERRED OR INCORPORATED IN ANY OTHER PROJECT IN ANY MANNER WITHOUT THE EXPRESS WRITTEN CONSENT OF SAMTEC, INC.

samtec
520 PARK EAST BLVD, NEW ALBANY, IN 47150
PHONE: 812-944-6733 FAX: 812-948-5047
e-Mail: info@SAMTEC.com code 53322

MATERIAL: DO NOT SCALE DRAWING SHEET SCALE: 5:1 DESCRIPTION: .050 x .050 CL DOUBLE VERTICAL SMT TERMINAL STRIP
INSULATOR: LCP UL 94 VO
TERMINAL: PHOSPHOR BRONZE
DWG. NO. FTSH-1XX-XX-XXX-DV-XXX-XXX
BY: PURVIS 10/12/1995 SHEET 1 OF 5

REVISION FD

FIG 2
-K OPTION

(LEAD STYLE -01 ONLY)
(DIFFERENT AS SHOWN, OTHERWISE SAME AS FIG 1)
(POSITION 13, 17, 20 & 25 AVAILABLE WITH
-EJ OPTION)

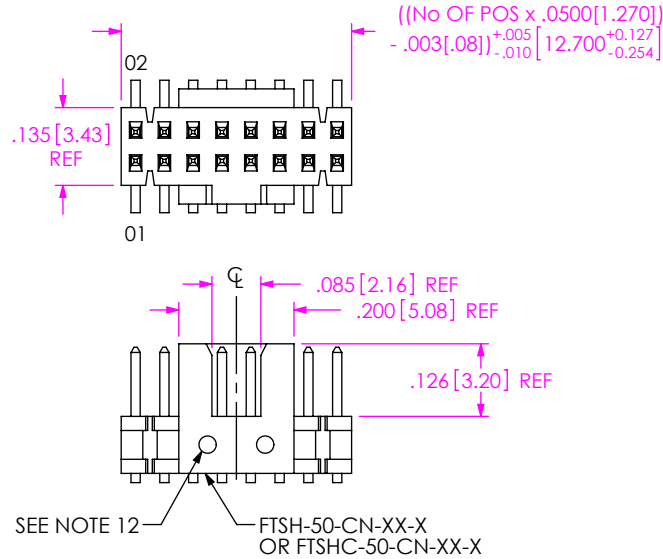

TABLE 3		
No OF POS	BODY	No OF PARTS PER FULL STRIP
-05	FTSH-50-CN-05	10
-06	FTSH-50-CN-06	8
-07	FTSH-50-CN-07	7
-08	FTSH-50-CN-08	6
-09	FTSH-50-CN-09	5
-10	FTSH-50-CN-10	5
-11	FTSH-50-CN-11	4
-12	FTSH-50-CN-12	4
-13	FTSH-50-CN-13	3
-14	FTSH-50-CN-14	3
-15	FTSH-50-CN-15	3
-16	FTSH-50-CN-16	3
-17	FTSH-50-CN-17	2
-18	FTSH-50-CN-18	2
-19	FTSH-50-CN-19	2
-20	FTSH-50-CN-20	2
-21	FTSH-50-CN-21	2
-22	FTSH-50-CN-22	2
-23	FTSH-50-CN-23	2
-24	FTSH-50-CN-24	2
-25	FTSH-50-CN-25	2

FIG 4
SCALE 2 : 1

-EJ OPTION
(DIFFERENT AS SHOWN, OTHERWISE SAME AS FIG 1)
(-01 LEAD STYLE ONLY)

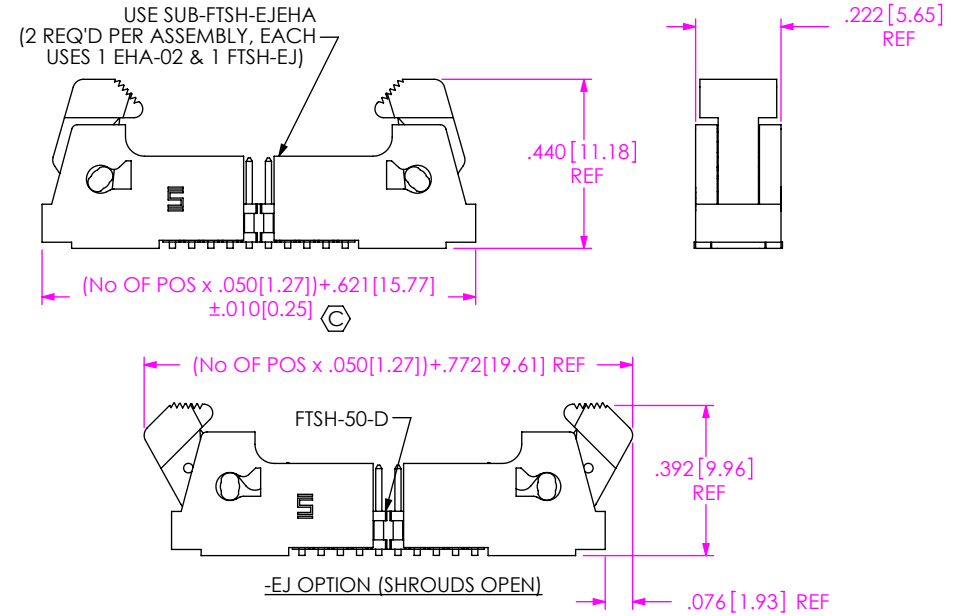

FIG 3
-A OPTION

(DIFFERENT AS SHOWN, OTHERWISE SAME AS FIG 1)
(6 POSITION MINIMUM FOR STAKED ALIGNMENT PINS)
(3 POSITION MINIMUM FOR MOLDED ALIGNMENT PINS)

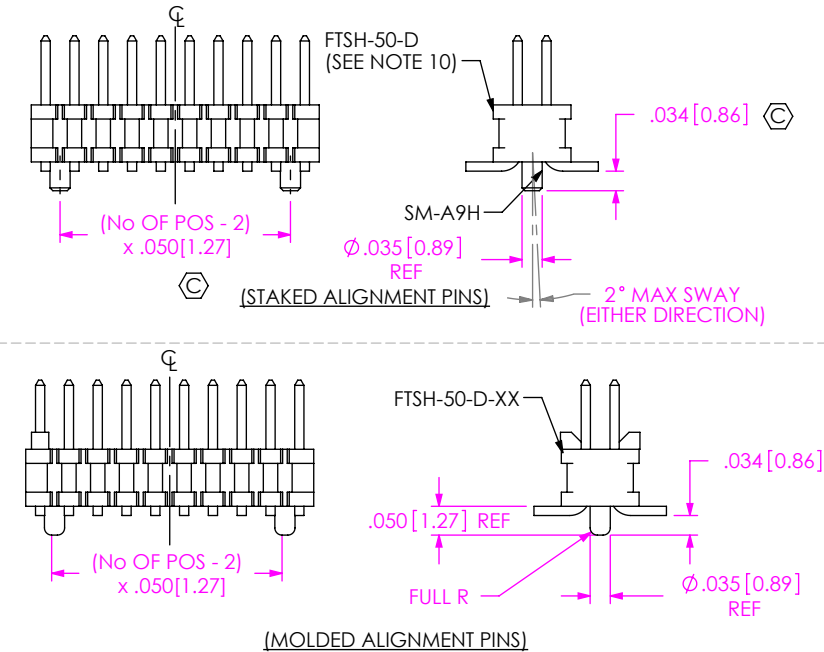
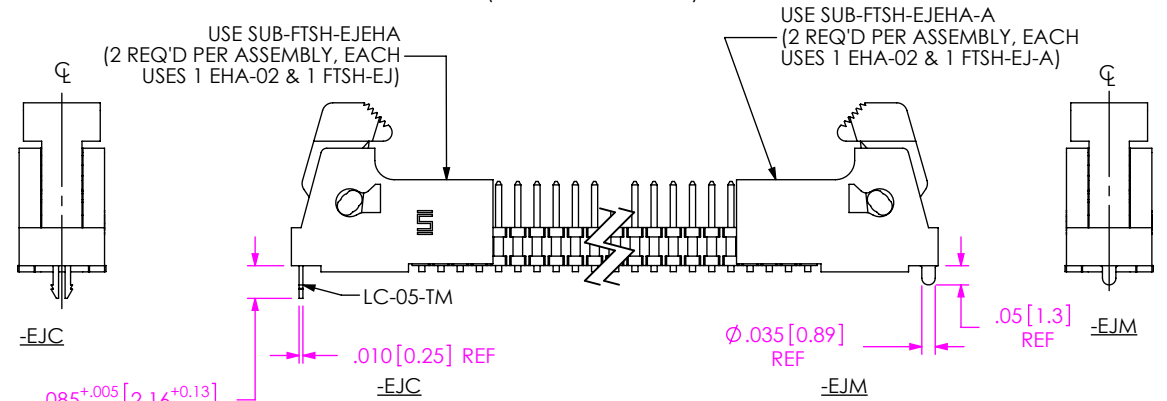

FIG 5
SCALE 2 : 1

-EJC & -EJM OPTIONS
(DIFFERENT AS SHOWN, OTHERWISE SAME AS FIG 4)
(-01 LEAD STYLE ONLY)



PROPRIETARY NOTE
 THIS DOCUMENT CONTAINS CONFIDENTIAL AND PROPRIETARY INFORMATION AND ALL DESIGN, MANUFACTURING, REPRODUCTION, USE, PATENT RIGHTS AND SALES RIGHTS ARE EXPRESSLY RESERVED BY SAMTEC, INC. THIS DOCUMENT SHALL NOT BE DISCLOSED, IN WHOLE OR PART, TO ANY UNAUTHORIZED PERSON OR ENTITY NOR REPRODUCED, TRANSFERRED OR INCORPORATED IN ANY OTHER PROJECT IN ANY MANNER WITHOUT THE EXPRESS WRITTEN CONSENT OF SAMTEC, INC.



520 PARK EAST BLVD, NEW ALBANY, IN 47150
 PHONE: 812-944-6733 FAX: 812-948-5047
 e-Mail info@SAMTEC.com code 53322

DO NOT SCALE DRAWING
 SHEET SCALE: 3:1

DESCRIPTION:
 .050 x .050 CL DOUBLE VERTICAL SMT TERMINAL STRIP
 DWG. NO.
FTSH-1XX-XX-XXX-DV-XXX-XXX
 BY: PURVIS 10/12/1995 SHEET 2 OF 5

FIG 6
-ES OPTION
(DIFFERENT AS SHOWN, OTHERWISE SAME AS FIG 1)
(USE -02 OR -03 LEAD STYLE ONLY)
(9 POS MIN FOR SNAP SHROUDS)
(5 POS MIN FOR MOLDED SHROUDS)

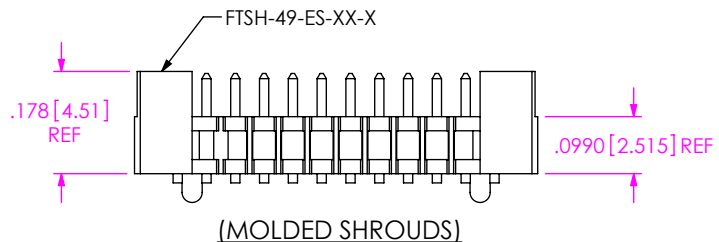
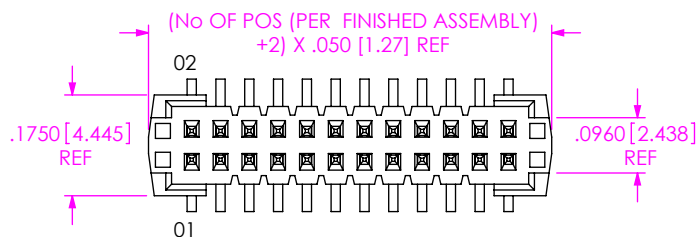
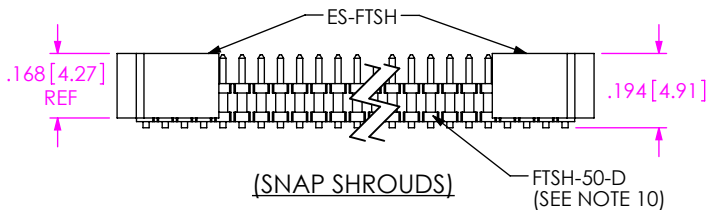
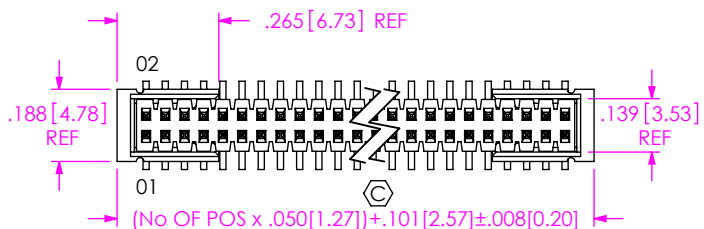

FIG 7
-EC OPTION
(DIFFERENT AS SHOWN, OTHERWISE SAME AS FIG 6)

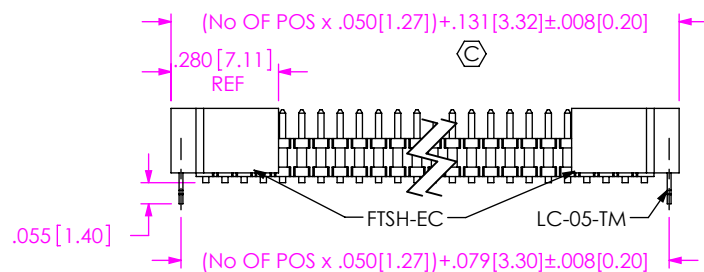

FIG 8
-EP OPTION
(DIFFERENT AS SHOWN, OTHERWISE SAME AS FIG 6)
(USE ONLY WHEN MATING WITH CLP)

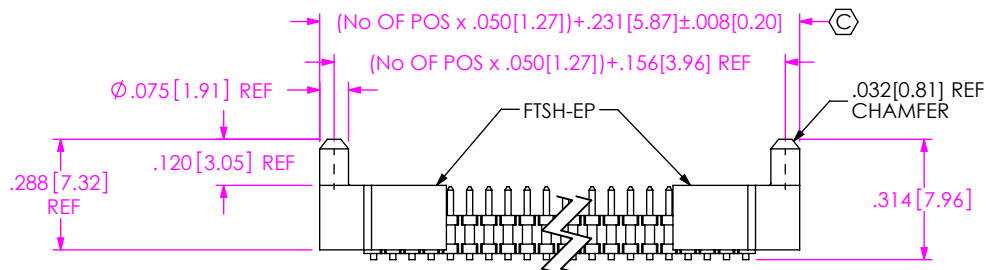

FIG 9
-EL OPTION
(DIFFERENT AS SHOWN, OTHERWISE SAME AS FIG 6)
(USE ONLY WHEN MATING WITH CLP)

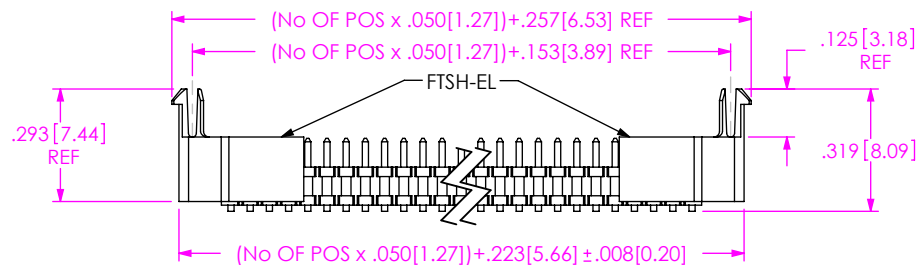
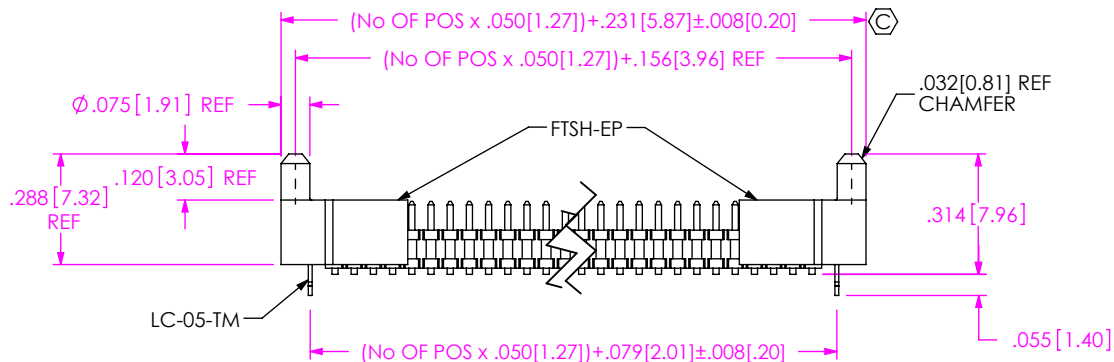

FIG 10
-EPC OPTION
(DIFFERENT AS SHOWN, OTHERWISE SAME AS FIG 6)
(USE ONLY WHEN MATING WITH CLP)



PROPRIETARY NOTE
THIS DOCUMENT CONTAINS CONFIDENTIAL AND PROPRIETARY INFORMATION AND ALL DESIGN, MANUFACTURING, REPRODUCTION, USE, PATENT RIGHTS AND SALES RIGHTS ARE EXPRESSLY RESERVED BY SAMTEC, INC. THIS DOCUMENT SHALL NOT BE DISCLOSED, IN WHOLE OR PART, TO ANY UNAUTHORIZED PERSON OR ENTITY NOR REPRODUCED, TRANSFERRED OR INCORPORATED IN ANY OTHER PROJECT IN ANY MANNER WITHOUT THE EXPRESS WRITTEN CONSENT OF SAMTEC, INC.

DO NOT SCALE DRAWING
SHEET SCALE: 2:1



520 PARK EAST BLVD, NEW ALBANY, IN 47150
PHONE: 812-944-6733 FAX: 812-948-5047
e-Mail info@SAMTEC.com code 53322

DESCRIPTION:
.050 x .050 CL DOUBLE VERTICAL SMT TERMINAL STRIP
DWG. NO.
FTSH-1XX-XX-XXX-DV-XXX-XXX
BY: PURVIS 10/12/1995 SHEET 3 OF 5

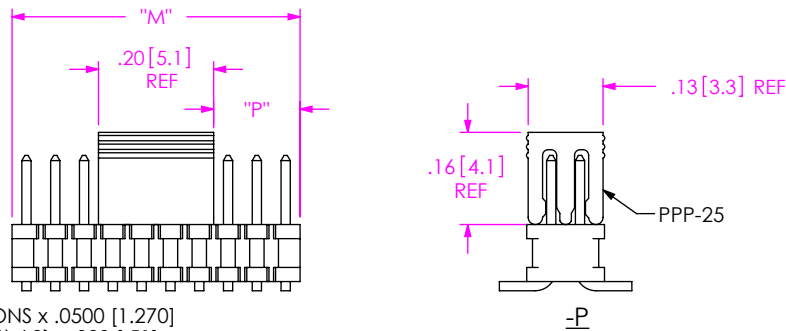

"M" = No OF POSITIONS x .0500 [1.270]
 "P" = {("M" -.200 [508]) / 2} ±.020 [.51]

FIG 11
 -P OPTION
 (DIFFERENT AS SHOWN,
 OTHERWISE SAME AS FIG 1)

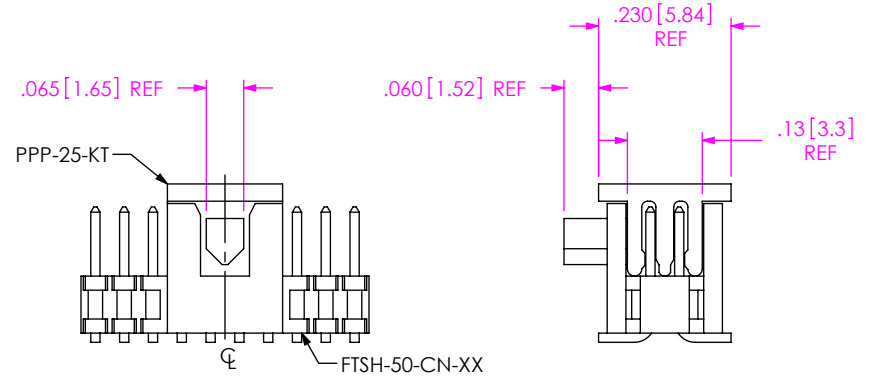

-K-P-TR
 (DIFFERENT AS SHOWN,
 OTHERWISE SAME AS FIG 2)

TABLE 5		
OPTION(S)	PAD	MIN. POS
NONE, -A	PPP-25**	4
-EJ, -EJC, -EJM	PPP-41	10
-ES, -EC, -EP, -EL	PPP-25**	9
-EPC	PPP-25**	5*
-K	PPP-25-KT	5
-K-EJ	PPP-25-KT	10

*MOLDED SHROUD ONLY
 ** USE PPP-25-NT WITH -TR
 PACKAGING ONLY

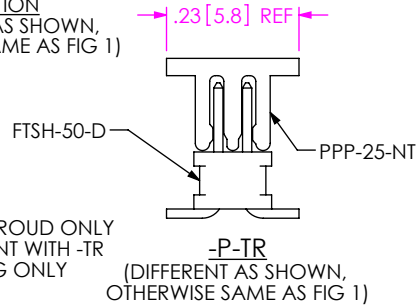

-P-TR
 (DIFFERENT AS SHOWN,
 OTHERWISE SAME AS FIG 1)

NOTE: TAPE & REEL ORIENTATION:
 POLARIZATION NOTCH TO THE RIGHT

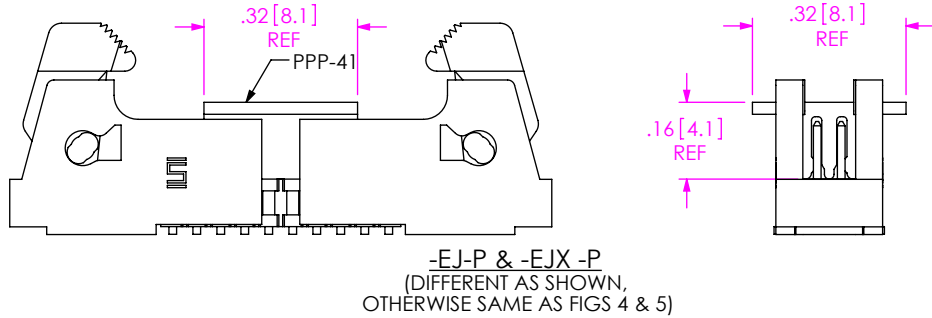

-EJ-P & -EJX -P
 (DIFFERENT AS SHOWN,
 OTHERWISE SAME AS FIGS 4 & 5)

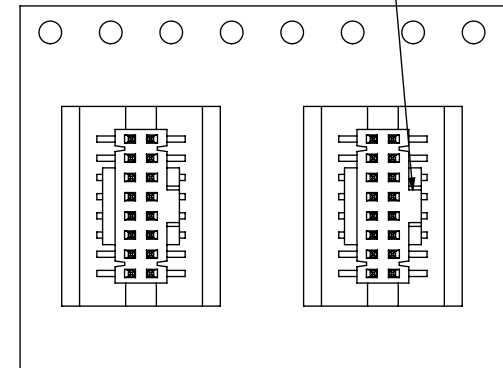

TAPE & REEL VIEW
 USER DIRECTION OF UN-REELING →
 POCKET NOT DETAILED

FIG 12
 *-M: METAL PICK & PLACE PAD
 (DIFFERENT AS SHOWN, OTHERWISE SAME AS FIG 1)
 (NOT AVAILABLE WITH -K OPTION)(5 POS MIN)
 * = NOT ENGINEERING APPROVED

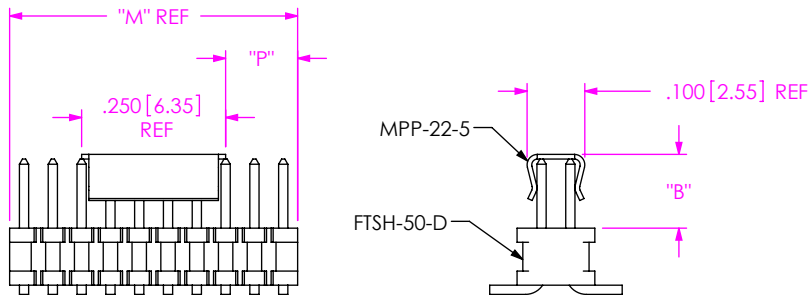

"M" = No OF POSITIONS x .0500 [1.270]
 "P" = {("M" -.250 [6.35]) / 2} ± .020 [0.51]

TABLE 4		
LEAD STYLE	"B" REF	
-01	.125	[3.18]
-02	.080	[2.03]
-03	.070	[1.78]
-04	.155	[3.94]
-14	.155	[3.94]

PROPRIETARY NOTE
 THIS DOCUMENT CONTAINS CONFIDENTIAL AND PROPRIETARY INFORMATION AND ALL DESIGN, MANUFACTURING, REPRODUCTION, USE, PATENT RIGHTS AND SALES RIGHTS ARE EXPRESSLY RESERVED BY SAMTEC, INC. THIS DOCUMENT SHALL NOT BE DISCLOSED, IN WHOLE OR PART, TO ANY UNAUTHORIZED PERSON OR ENTITY NOR REPRODUCED, TRANSFERRED OR INCORPORATED IN ANY OTHER PROJECT IN ANY MANNER WITHOUT THE EXPRESS WRITTEN CONSENT OF SAMTEC, INC.

DO NOT SCALE DRAWING

SHEET SCALE: 3:1



520 PARK EAST BLVD, NEW ALBANY, IN 47150
 PHONE: 812-944-6733 FAX: 812-948-5047
 e-Mail: info@SAMTEC.com code 53322

DESCRIPTION:
 .050 x .050 CL DOUBLE VERTICAL SMT TERMINAL STRIP

DWG. NO.
FTSH-1XX-XX-XXX-DV-XXX-XXX

BY: PURVIS 10/12/1995 SHEET 4 OF 5

FIG 13
TUBE VIEWS

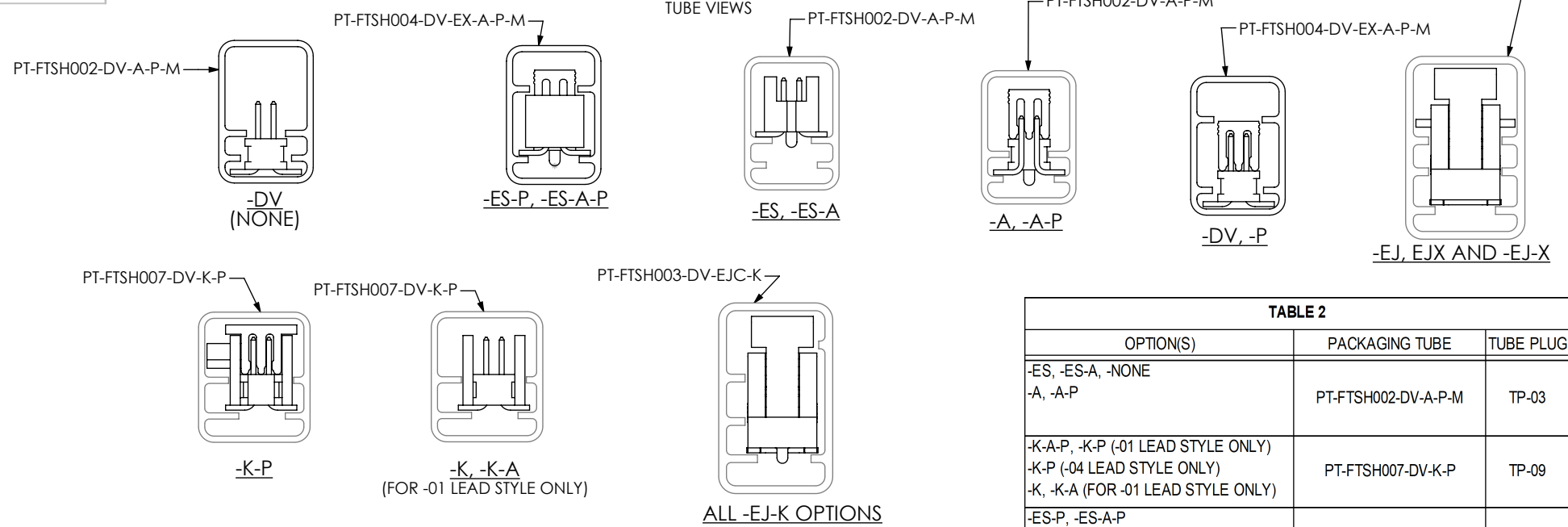
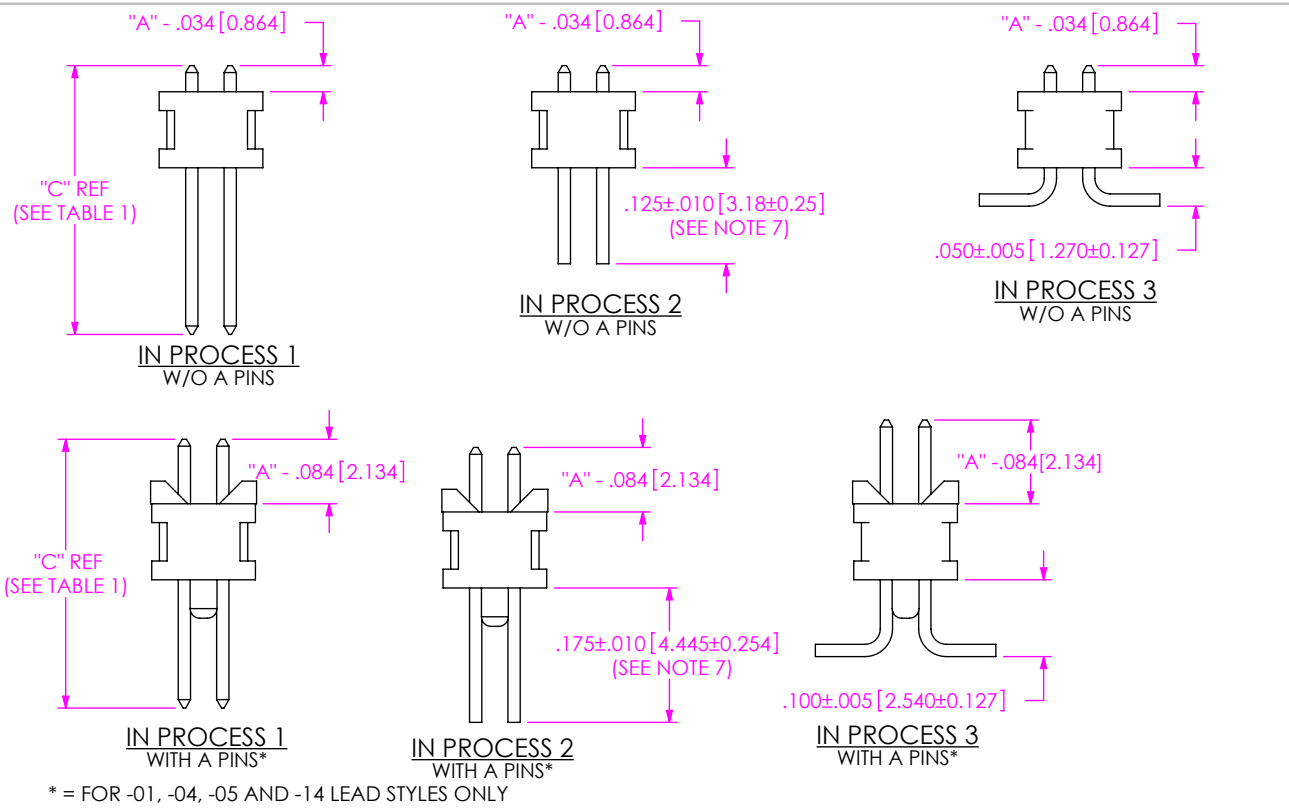

TABLE 2		
OPTION(S)	PACKAGING TUBE	TUBE PLUG
-ES, -ES-A, -NONE -A, -A-P	PT-FTSH002-DV-A-P-M	TP-03
-K-A-P, -K-P (-01 LEAD STYLE ONLY) -K-P (-04 LEAD STYLE ONLY) -K, -K-A (FOR -01 LEAD STYLE ONLY)	PT-FTSH007-DV-K-P	TP-09
-ES-P, -ES-A-P -EC, -EC-P, -EL-P -EP, -EP-A, EP-P, -EP-A-P -EPC, -EPC-D, -EPC-P -EL, -EL-A, -EL-A-P -P (ALL LEAD STYLES)	PT-FTSH004-DV-EX-A-P-M	TP-03
-EJ-K, -EJ-K-P -EJ-K-A, -EJ-K-A-P	PT-FTSH003-DV-EJC-K	TP-03
-EJ, -EJ-P, -EJ-A-P, -EJ-A, -EJM, -EJC	PT-FTSH006-DV-EJC-K-P	TP-03



IN-PROCESS VIEWS ARE FOR HANDFILL ONLY

PROPRIETARY NOTE
THIS DOCUMENT CONTAINS CONFIDENTIAL AND PROPRIETARY INFORMATION AND ALL DESIGN, MANUFACTURING, REPRODUCTION, USE, PATENT RIGHTS AND SALES RIGHTS ARE EXPRESSLY RESERVED BY SAMTEC, INC. THIS DOCUMENT SHALL NOT BE DISCLOSED, IN WHOLE OR PART, TO ANY UNAUTHORIZED PERSON OR ENTITY NOR REPRODUCED, TRANSFERRED OR INCORPORATED IN ANY OTHER PROJECT IN ANY MANNER WITHOUT THE EXPRESS WRITTEN CONSENT OF SAMTEC, INC.

DO NOT SCALE DRAWING
SHEET SCALE: 2:1



520 PARK EAST BLVD., NEW ALBANY, IN 47150
PHONE: 812-944-6733 FAX: 812-948-5047
e-Mail: info@SAMTEC.com code 53322

DESCRIPTION:
.050 x .050 CL DOUBLE VERTICAL SMT TERMINAL STRIP
DWG. NO.
FTSH-1XX-XX-XXX-DV-XXX-XXX
BY: PURVIS 10/12/1995 SHEET 5 OF 5